

# Thermodynamic Analysis of Resources Used in Manufacturing Processes<sup>1</sup>

Timothy G. Gutowski, and Dusan P. Sekulic

## INTRODUCTION

The main purpose of manufacturing processes is to transform materials into useful products. In the course of these operations, energy resources are consumed and the usefulness of material resources is altered. Each of these effects can have significant consequences for the environment and for sustainable development, particularly when the processes are practiced on a very large scale. Thermodynamics is well suited to analyze the magnitude of these effects as well as the efficiency of the resources transformations. The framework developed here is based upon exergy analysis that is developed in the first two chapters of this book. Also see (1-5). The data for this study draws upon previous work in the area of manufacturing process characterization, but also includes numerous measurements and estimates we have conducted. In all, we analyze 26 different manufacturing processes often in many different instances for each process. The key process studies from the literature are: for micro-electronics, Murphy et al (6), Williams et al (7), Krishnan et al (8), Zhang et al (9), and Boyd et al (10); for nano-materials processing, Isaacs et al (11) and Khanna et al (12); for other manufacturing processes, Morrow et al (13), Boustead (14, 15), Munoz and Sheng (16), and Mattis et al (17). Some of our own work includes Dahmus and Gutowski (18), Dalquist and Gutowski (19), Thiriez and Gutowski (20, 21), Baniszewski (22), Kurd (23), Cho (24), Kordonowy (25), Jones (26), Branham et al (27, 28), and Gutowski et al (29). Several texts and overviews also provide useful process data (30-35) and additional manufacturing process studies of ours include Sekulic (36), Jayasankar (37), Sekulic and Jayasankar (38), Bodapati (39) and Subramaniam and Sekulic (40).

## THERMODYNAMIC FRAMEWORK

Manufacturing can often be modeled as a sequence of open thermodynamic processes (27) as proposed by Gyftopoulos and Beretta for materials processing (1). Each stage in the process can have work and heat interactions, as well as materials flows. The useful output, primarily in form of material flows of products, and by-products from a given stage can then be passed on to the next. Each step inevitably

involves losses due to an inherent departure from reversible processes, hence generates entropy and a stream of waste materials and exergy losses (often misinterpreted as energy losses).<sup>2</sup>

Figure 1 depicts a generalized model of a manufacturing system (27, 50). The manufacturing subsystem ( $\Omega_{MF}$ ) receives work  $W$  and heat  $Q$  from an energy conversion subsystem ( $\Omega_{ECMF}$ ). The upstream input materials come from the materials processing subsystem ( $\Omega_{MA}$ ), which also has an energy conversion subsystem ( $\Omega_{ECMA}$ ). This network representation can be infinitely expanded to encompass ever more complex and detailed inputs and outputs (31, 32).

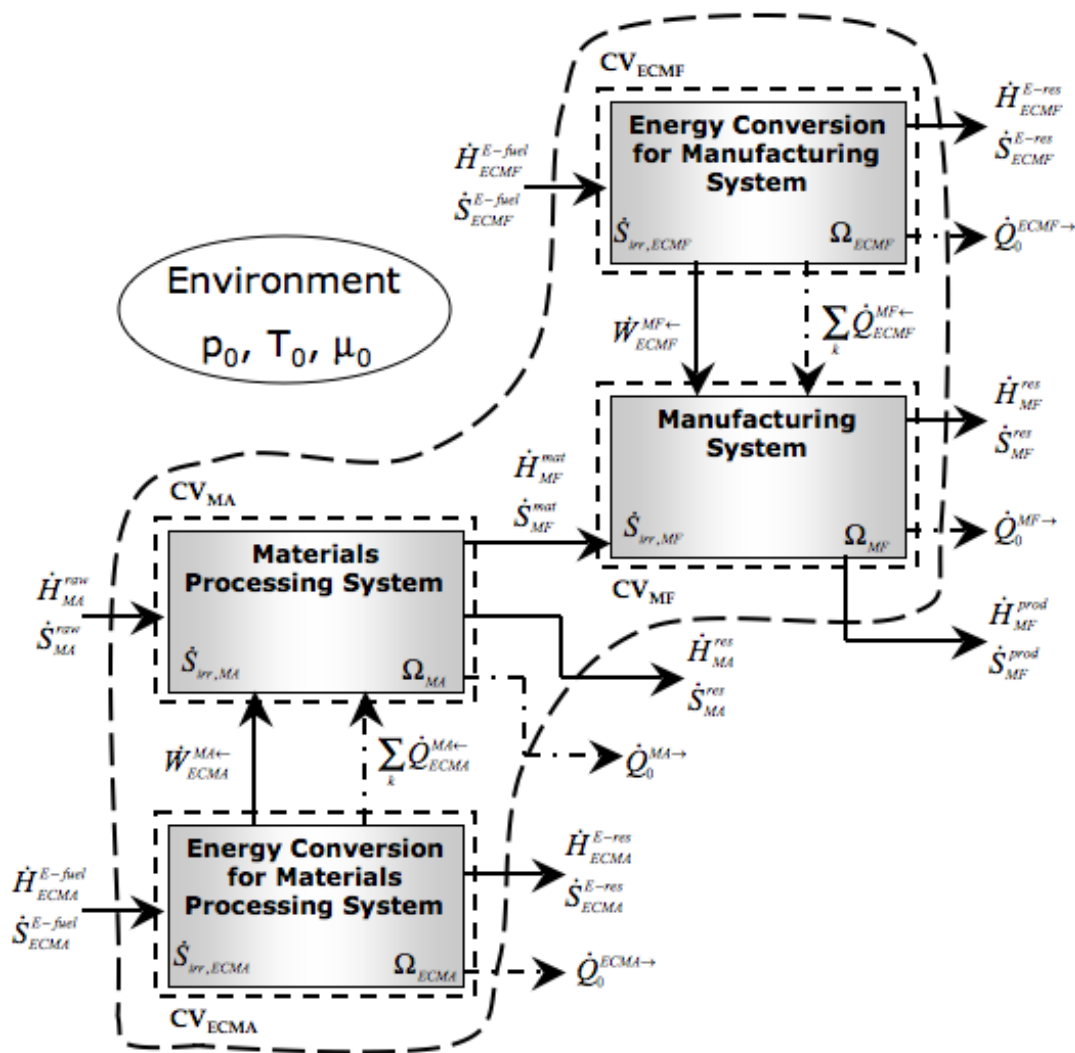

Figure 1: Diagram of a Coupled Manufacturing and Materials Processing Systems  
(Ref. 50, adapted from (1))

At each stage, the sub- systems interact with the environment (at some reference pressure  $p_0$ , temperature  $T_0$  and chemical composition, which is given by mole fractions  $x_i$ ,  $i \in (1, n)$ , of  $n$  chemical compounds, characterized by chemical potentials  $\mu_{i,0}$ ) The performance of these sub- systems can then be described in thermodynamic terms by formulating mass, energy, and entropy balances. Beginning with the manufacturing sub-system  $\Omega_{MF}$  featuring the system's mass  $M_{MF}$ , energy  $E_{MF}$ , and entropy  $S_{MF}$ , we have three basic rate equations<sup>3</sup>:

**Mass Balance:**

$$\frac{dM_{MF}}{dt} = \left( \sum_{i=1} \dot{N}_{i,in} \tilde{M}_i \right)_{MF} - \left( \sum_{i=1} \dot{N}_{i,out} \tilde{M}_i \right)_{MF} \quad (1)$$

where  $\dot{N}_i$  is the amount of matter per unit time of the  $i^{\text{th}}$  component entering or leaving the system and  $\tilde{M}_i$  is the molar mass of that component.

**Energy Balance:**

$$\frac{dE_{MF}}{dt} = \sum_k \dot{Q}_{ECMF,k}^{MF\leftarrow} - \dot{Q}_0^{MF\rightarrow} + \dot{W}_{ECMF}^{MF\leftarrow} + \dot{H}_{MF}^{mat} - \dot{H}_{MF}^{prod} - \dot{H}_{MF}^{res} \quad (2)$$

Where  $\dot{Q}_{ECMF,k}^{MF\leftarrow}$  and  $\dot{W}_{ECMF}^{MF\leftarrow}$  represent rates of energy interactions between the manufacturing subsystem ( $\Omega_{MF}$ ) and its energy supplying subsystem ( $\Omega_{ECMF}$ ). The  $\dot{H}$  terms signify the lumped sums of the enthalpy rates of all materials, products, and residue bulk flows into/out of the manufacturing system. Note that a heat interaction between  $\Omega_{MF}$  and the environment, denoted by the subscript “o” is assumed to be out of the system (a “loss” into the surroundings) at the local temperature  $T_0$ .

**Entropy Balance:**

$$\frac{dS_{MF}}{dt} = \sum_k \frac{\dot{Q}_{ECMF,k}^{MF\leftarrow}}{T_k} - \frac{\dot{Q}_0^{MF\rightarrow}}{T_0} + \dot{S}_{MF}^{mat} - \dot{S}_{MF}^{prod} - \dot{S}_{MF}^{res} + \dot{S}_{irr,MF} \quad (3)$$

where  $\dot{Q}^{MF}/T$  terms represent the entropy flows accompanying the heat transfer rates exchanged between the subsystem  $\Omega_{MF}$  and energy supplying subsystem ( $\Omega_{ECMF}$ ) and environment, respectively while  $\dot{s}_i$  terms indicate the lumped sums of the entropy rates of all material flows. The term  $S_{irr, MF}$  represents the entropy generation caused by irreversibilities generated within the manufacturing subsystem.

Assuming steady state, and eliminating  $\dot{Q}_0$  between equations (2) and (3) yields an expression for the work rate requirement for the manufacturing process:

$$\dot{W}_{ECMF}^{MF\leftarrow} = ((\dot{H}_{MF}^{prod} + \dot{H}_{MF}^{res}) - \dot{H}_{MF}^{mat}) - T_0((\dot{S}_{MF}^{prod} + \dot{S}_{MF}^{res}) - \dot{S}_{MF}^{mat}) - \sum_{k>0} \left(1 - \frac{T_0}{T_k}\right) \dot{Q}_{ECMF}^{MF\leftarrow} + T_0 \dot{S}_{irr, MF} \quad (4)$$

The quantity H-TS appears often in thermodynamic analysis and is referred to as the Gibbs free energy. In this case, a different quantity appears,  $H-T_oS$ . The difference between this and the same quantity evaluated at the reference state (denoted by the subscript “o”) is called exergy,  $\dot{E}x = (\dot{H} - T_o\dot{S}) - (\dot{H} - T_o\dot{S})_o$ .<sup>4</sup> Exergy of a material flow represents the maximum amount of work that could be extracted from the flow considered as a separate system as it is reversibly brought to equilibrium with a well-defined environmental reference state. In general, the bulk-flow terms in (4) may include contributions that account for both the physical and chemical exergies, hence  $\dot{E}x = \dot{E}x^{ph} + \dot{E}x^{ch}$ , as well as kinetic and potential exergy (not considered in this discussion), see (2 – 5).

The physical exergy is that portion of the exergy that can be extracted from a system by bringing a system in a given state to the “*restricted dead state*” at a reference temperature and pressure ( $T_o, p_o$ ). The chemical exergy contribution represents the additional available energy that can be extracted from the system at the restricted dead state by bringing the chemical potentials  $\mu^*_i$  of a component  $i \in (1, n)$  at that state ( $T_o, p_o$ ) to equilibrium with its surroundings at the *ultimate dead state*, or just the “*dead state*” ( $T_o, p_o, \mu_{i,o}$ ). In addition to requiring an equilibrium at the reference temperature and pressure, the definition of chemical exergies also requires an equilibrium at reference state with respect to a specified chemical composition. This reference state is typically taken to be (by convention) representative of the compounds in the earth’s upper

crust, atmosphere, and oceans. In this chapter, exergy values are calculated using the Szargut reference environment (5). Several updates and alternative references, environments are available, but they do not change the accuracy of this development.<sup>5</sup> See Appendix A of this book for an extensive list of standard chemical exergies taken from Szargut (53) and others.

Substituting and writing explicit terms for the expressions for physical and chemical exergy allows us to write the work rate as,

$$\begin{aligned} \dot{W}_{ECMF}^{MF\leftarrow} = & ((\dot{E}x_{MF}^{prod,ph} + \dot{E}x_{MF}^{res,ph}) - \dot{E}x_{MF}^{mat,ph}) + \left(\sum_{i=1}^n e_{x_{i,o}}^{ch} \dot{N}_i\right)_{MF}^{prod} + \left(\sum_{i=1}^n e_{x_{i,o}}^{ch} \dot{N}_i\right)_{MF}^{res} \\ & - \left(\sum_{i=1}^n e_{x_i}^{ch} \dot{N}_i\right)_{MF}^{mat} - \sum_{k>0} \left(1 - \frac{T_0}{T_k}\right) \dot{Q}_{ECMF}^{MF\leftarrow} + T_0 \dot{S}_{irr,MF} \end{aligned} \quad (5)$$

Using the same analysis for the system  $\Omega_{ECMF}$  yields:

$$\dot{W}_{ECMF}^{MF\leftarrow} = (\dot{E}x_{ECMF}^{E-fuel,ph} - \dot{E}x_{ECMF}^{E-res,ph}) + \left(\sum_{i=1}^n e_{x_{0,i}}^{ch} \dot{N}_i\right)_{ECMF}^{E-fuel} - \left(\sum_{i=1}^n e_{x_{0,i}}^{ch} \dot{N}_i\right)_{ECMF}^{E-res} - \sum_{k>0} \left(1 - \frac{T_0}{T_k}\right) \dot{Q}_{ECMF}^{MF\leftarrow} - T_0 \dot{S}_{irr,ECMF} \quad (6)$$

Here we have purposefully separated out the physical exergies, written as extensive quantities  $Ex$ , and the chemical exergies, where  $e_{x_{i,o}}^{ch}$  represent the molar chemical exergies in the “restricted dead state” (2). We do this to emphasize the generality of this framework and the significant differences between two very important applications. In resource accounting, as done in Life Cycle Analysis, the physical exergy terms are often not included. Hence the first bracketed term on the right hand side of equation (5) becomes zero because the material flows enter and exit the manufacturing process at the restricted dead state<sup>6</sup> However many manufacturing processes involve material flows with non-zero physical exergies at system boundaries (31, 32, 34). To analyze these processes, and in particular to estimate the minimum work rate, and exergy lost, these terms must be retained. This is typical for an engineering analysis of an energy system. Note that similar equations can also be derived for the systems  $\Omega_{MA}$  and  $\Omega_{ECMA}$ . Before proceeding, it is worth pointing out several important insights from these results. First, in both equations (5) and (6) we see that the magnitude of the work input is included fully while the heat inputs are modified (reduced) by a Carnot factor  $(1-T_0/T_k)$ . Hence, in exergy analysis, work and

heat are not equivalent, as they are in First Law analysis. Secondly, equation (5) provides the framework for estimating the minimum work input for any process, i.e., when irreversibilities are zero,  $T_o S_{irr} = 0$ . The analytical statements formulated in equations 5 and 6 feature all the energy interactions (including the energy carried by material streams) in terms of exergies – i.e., the available energy equivalents of all energy interactions. Such a balance may be written in general, for an arbitrary open system  $\Omega$  (including the one presented in Fig. 1) as follows, see Fig. 2

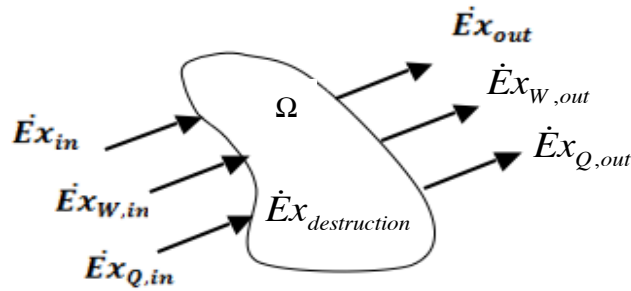

Figure 2 . Components of An Exergy Balance for Any Arbitrary Open Thermodynamic System

$$\dot{E}x_{in} + \dot{E}x_{W,in} + \dot{E}x_{Q,in} = \dot{E}x_{out} + \dot{E}x_{W,out} + \dot{E}x_{Q,out} + \dot{E}x_{destruction} \quad (7)$$

In Eq. (7), the exergy components (i.e., exergy modes) of the balance are as follows: (i)  $\dot{E}x_{in/out} = \dot{E}x_{in/out}^{ph} + \dot{E}x_{in/out}^{ch}$ , (ii)  $\dot{E}x_{W,in/out} = \dot{W}_{in/out}$ , (iii)  $\dot{E}x_{Q,in/out} = (1 - T_o / T) \dot{Q}_{in/out}$ , and (iv)  $\dot{E}x_{destruction} = T_o \dot{S}_{irr}$ . Work required beyond the minimum work, by definition, is lost. This represents exergy destroyed ( $\dot{E}x_{destruction}$ )<sup>7</sup>.

## ESTIMATING THE MINIMUM WORK FOR MATERIALS TRANSFORMATIONS IN MANUFACTURING PROCESSES

Materials transformations in manufacturing processes can be produced by energy and/or mass interactions in the form of either work inputs/outputs or heat inputs/outputs, respectively and/or in some cases, mass flow inputs involving chemical processes and/or mass flow inputs/outputs involving either auxiliary or waste material. These interactions are directly related to the resource needs and may be expressed in terms of exergy. The identification of inputs/outputs depends on how one draws the boundaries of a system exposed to the process. Here we adhere to the convention suggested in the system drawing in Figure 1, that is we identify the manufacturing/materials processing sub-system that must be provided with energy and material flows. Calculating the resources needs in terms of the minimum exergy input can be an important aid in identifying the efficiency of processes and components of processes, and thereby identifying opportunities for improvement.<sup>8</sup> Here we will introduce the topic of estimating the minimum resources requirements for typical material transformations that take place in manufacturing processes. We will also use these results to compare with the actual resources used.

### Temperature and Pressure Changes for Open Materials Processing Systems

Let us define as the system a material flow that must change the state by changing the temperature and pressure. Let us specify that this change should be inflicted by a work interaction (an energy interaction characterized with no associated entropy flow). Starting from equation 5, consider the case of a continuous steady state flow. Here there are no chemical reactions and correspondingly no changes in chemical exergy. There are no heat inputs. Further we assume 100% yield so that the residual material stream is zero, and all of the input material is converted to product. To calculate the minimum work rate input, we set  $\dot{T}_o \dot{S}_{irr} = 0$ . This gives (with simplified notation),

$$\dot{W}_{\min} = \dot{E}x^{prod} - \dot{E}x^{mat} = \dot{E}x_{out} - \dot{E}x_{in} = \dot{m}(e_{x,out} - e_{x,in}) = \dot{m}(b_{out} - b_{in}) \quad (8)$$

In Eq. (7),  $e_i = h_i - h_{i,o} - T_o(s_i - s_{i,o})$  and  $b_i = h_i - T_o s_i$ . This latter function is called the availability function.<sup>9</sup>

Writing the minimum work rate per unit of mass rate processed gives

$$w_{\min} = \frac{\dot{W}_{\min}}{\dot{m}} = b_{out} - b_{in} \quad (9)$$

Determination of the specific minimum work reduces to the determination of availability functions at the given terminal ports of the open material processing system. That is, determining the state properties  $h_{in}$ ,  $h_{out}$ , and  $s_{in}$ ,  $s_{out}$ , or if expressed in terms of exergy change determining additionally the enthalpy and entropy values for the same system at its dead state, i.e., when in equilibrium with the surroundings at  $(T_o, p_o)$ .

In differential form

$$dw_{\min} = db = dh - T_o ds \quad (10)$$

(Note that we can write  $dw_{\min}$  rather than  $\delta w_{\min}$  because while work is not a state variable, the minimum work, which is a function of other state and environmental variables, is a state variable).

The task of calculating the minimum work then comes down to integrating equation (10) between the terminal states of the materials process, with the proper temperature and pressure dependencies for  $dh$  and  $ds$  for the given change of state. This calculation would be possible for a given system only after specifying related constitutive relationship for the assumed substance models. This can be done by identifying real or assuming certain idealized behavior for the materials being processed and assuming a reversible change of state of the system exposed to bulk mass flow rates and work interaction only. For example, for a pure, simple compressible system and internally reversible process one can write  $Tds = dh - vdp$ . Now using the definition of enthalpy, one can write for incompressible substances.

$$dh = cdT + vdp \quad (11)$$



and

$$ds = c \frac{dT}{T} \quad (12)$$

Here  $c$  is the specific heat,  $v$  is the specific volume and  $p$  is pressure.

Following a similar procedure for ideal gases these relationships are:

$$dh = c_p dT \quad (13)$$

$$ds = c_p \frac{dT}{T} - R \frac{dp}{p} \quad (14)$$

Here  $c_p$  is the specific heat at the constant pressure of the ideal gas.  $R = \bar{R} / M$  where  $\bar{R} = 8.314$   $J/mol K$  is the Universal gas constant, and  $M$  the atomic or molecular weight.

As an example, consider a process that increases the temperature of a material in preparation for molding. We are interested in the minimum electrical work rate required to cause this transformation. This could represent the minimum electrical power input needed for an electrical resistance heater, a device commonly used in manufacturing. Here the material remains in the condensed phase, and we assume the process takes place at atmospheric pressure. The system boundary crosses the electrical current leads, so the interaction does not involve heat transfer if no heat losses are assumed.

Substitution of equations (11) and (12) into (10) and integration from  $T_o$  to  $T$  yields

$$w_{\min} = c(T - T_o) - T_o c \ln \frac{T}{T_o} \quad (15)$$

Reconsider now the same problem of energy resource use in form of heat, not work. That means, consider the system boundary as being crossed by Joule energy delivered as heat across the system boundary.

To calculate the heat  $Q$  required to raise the temperature of our system from  $T_o$  to  $T$  with no work involved, one should just use the energy balance as stated by the first law of thermodynamics. This heat input equals the enthalpy change in the steady state process from the given state of equilibrium with the surroundings,  $T_o$ , to the final state,  $T$ , i.e.,

$$q_{\min} = c(T - T_o) \quad (16)$$

This gives the heat transfer rate per unit of mass flow rate, which is larger than the minimum work. Note that  $c$  is assumed constant over the temperature range. This heat transfer rate is the minimum needed assuming that no heat losses are present.

Consider now a system exposed to phase change. The heat input needed is just the enthalpy of phase change (solid to liquid phase at the constant temperature)  $h_{sf}$  but the exergy value of the heat needed for phase change is less. This again is because the work can be converted to a full extent reversibly, but heat cannot. If the enthalpy change during melting is  $h_{sf}$ , then because the liquid ( $f$ ) and solid ( $s$ ) phases are in equilibrium at  $T_m$ , i.e.  $h_f - T_m s_f = h_s - T_m s_s$ , it follows that  $s_s - s_l = \Delta s = h_{sf}/T_m$  where  $h_s - h_f = \Delta h = h_{sf}$ . Rewriting eq. (10) as  $w_{\min} = \Delta h - T_o \Delta s$  gives,

$$w_{\min} = h_{sf} \left(1 - \frac{T_o}{T_v}\right) \quad (17)$$

The exergy needed for vaporization can be developed in a manner analogous to melting as

$$w_m = h_{fg} \left(1 - \frac{T_o}{T_b}\right) \quad (18)$$

### Example 1.0: Heel Electric Induction Melting of Iron

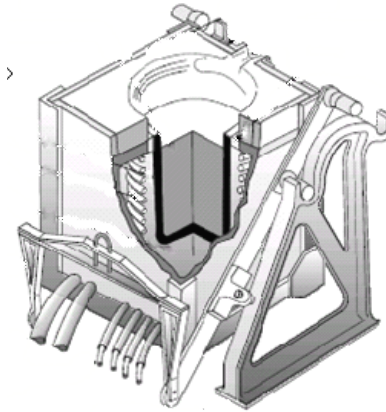

Figure 3: Diagram of an Electric Induction Furnace for Melting Iron [26]

One way of preparing the melt for production in an iron foundry is to use a “Heel” electric induction furnace. An electric induction furnace creates an electromagnetic field in the metal by virtue of an alternating current that runs through coils which are wound around a refractory lining. The effect is to melt and stir the metal. A metal heel is retained in the furnace to maintain the effect even while molten metal is periodically tapped from the furnace.

Here we model this process as an open system in steady state at atmosphere pressure with a work input (electricity) that increases the temperature and then melts the input iron. For the sake of simplicity, we do not include in the system the material of the induction furnace (that is, we assume that electrical work interacts with the processed material only). First we raise the temperature from  $T_o = 293\text{K}$  to  $T_m = 1813\text{K}$ . We determine the minimum work required using equation (15) and assuming a nominal value for  $c$  of  $0.67\text{J/gK}$  [41]. And then we assume an additional investment of work for melting the iron at a constant melt temperature  $T_m$ , using  $h_{sf} = 272\text{J/g}$  and

equation (17). This gives us an estimate of the minimum work as,  $w_{min} = 889J/g$ , or  $0.9MJ/kg$  (*melt*). Electricity data for heel induction melters used in iron foundries range from 570 – 1000 kWh/tonne (melt) or 2.1 to 3.6 MJ/kg (melt) depending upon operating parameters [26]. If we measure the efficiency of these melters in terms of  $w_{min}/w_{actual}$  we get a range from 25% to 43%. (Efficiency measures are discussed in more detail later in this chapter and in Chapters 1 and 2 of this book.) The lower value reflects a furnace run at a suboptimal production rate, and inefficient input energy resources conversion. For example, a heel furnace could be left on over a weekend or holiday without production to maintain the heel and avoid start-up. However, even the higher value (43%) may be considered as being lower than one might expect. For example, the thermal efficiency, using the minimum enthalpy change as  $c(T - T_o) + h_{sf}$  and using the enthalpy equivalent of the electricity input as the actual, one would get 62%. In general, using the reversible work in an efficiency comparison is a more stringent requirement than the more familiar so called first law efficiencies such as the thermal efficiency given as the minimum heat required/actual heat input. That aside, the reasons for the inefficiencies in the induction furnace include heat loss from the vessel, and heat losses in the inductor, as well as inefficiencies in the interactions within the electromagnetic field and material. The first is controlled by the temperature gradient across the walls of the vessel, the second depends on load shifting between heating the metal and heating the coils and the third depends on the energy conversion within the system. In most designs the heating coils are water cooled copper tubes. The cooling of the copper tubes represents a heat loss and guarantees a temperature gradient across the vessel walls. One way to improve the performance in such an operation would be to use the lost heat to preheat the incoming material charge. This will be especially true in cold regions of the world where the input material may be well below the standard value for  $T_o$  and preheating with “waste heat” could make a significant improvement in efficiency. Secondly, also note that while we have only calculated the minimum work up to  $T_m$ , actual operations will tend to raise the temperature higher than this.

**Example 2.0: Production of carbon single walled nanotubes by the high pressure CO process (HiPco).**

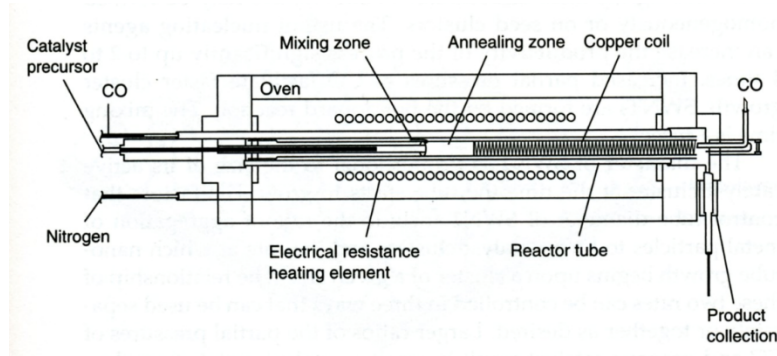

Figure 4 Apparatus for HiPco process [42]

Single walled nanotubes (SWNT) can be produced in a gas phase reaction using carbon monoxide as the carbon source and an iron compound as a catalyst. For the reaction to proceed efficiently both high temperatures ( $\sim 1000^\circ\text{C}$ ) and high pressures ( $\sim 30$  atm) are required. This process was developed by Prof. Richard Smalley's team at Rice University, who documented the process in sufficient detail so as to allow an estimate of the minimum work (electricity) rate to produce these materials [43].

Again we model the process as an ideal steady state open system. There are no heat inputs, nor losses, and the temperature and pressure increases are performed reversibly. It can be shown that the change in chemical exergy for the process is small compared to the required change in physical flow exergy and can be ignored, primarily because the conversion rate is so low [44]. The simplified version of the process we analyze then, comes down to the task of raising the temperature from  $273^\circ\text{K}$  to  $1273^\circ\text{K}$  and the pressure from 1 atm to 30 atm of a CO gas stream modeled as an ideal gas. [43, 44].

Using equations (10) (13) and (14) and integrating between  $T_o$  and  $T$  and  $p_o$  and  $p$  gives,

$$w_{\min} = c_p(T - T_o) - c_p T_o \ln \frac{T}{T_o} + T_o R \ln \frac{p}{p_o} \quad (19)$$

Now using the nominal value of  $c_p = 1130 \text{ J/kg.K}$  (this value ranges from  $1040$  at  $293\text{K}$  to  $1227 \text{ J/kg.K}$  at  $1250\text{K}$ ) one can calculate the work requirement to raise the temperature from  $293\text{K}$  to  $1273\text{K}$  as  $0.65 \text{ MJ/kg CO}$ , and to raise the pressure of the CO gas from  $1$  to  $30 \text{ atm}$  as  $0.64 \text{ MJ/kg CO}$ . This yields a total exergy requirement of  $1.29 \text{ MJ/kg CO}$ . Very early versions of this process were performed open loop. The hot gas was exhausted and the SWNTs were collected and purified. At this stage the conversion rate was quite small, with the actual yield in terms of incoming CO to the SWNT output, at  $45,000:1$ . This results in an overall minimum exergy requirement of  $58 \text{ GJ/kg SWNT}$ . Even without assuming any losses, this high value makes SWNTs by this process among the most energy intensive materials known.

Subsequent improvements however, including the recycling of the CO gas, have greatly improved the production yield for this process, resulting in current estimates of the actual electricity used to about  $32 \text{ GJ/kg}$  [44]. More details on the thermodynamic analysis of this process can be found in [44].

### **Example 3.0: Metal Cutting and Forming**

A number of manufacturing processes shape the work piece material primarily by plastic deformation. These would include machining and grinding processes as well as forming processes such as sheet metal stamping, rolling, extrusion, forging and others. In all cases of deformation processing the plastic work is converted in large part to thermal energy and not recovered. Hence these processes are irreversible. We can calculate a minimum work requirement from mechanics using idealized material behavior models and simplified loading configurations. Here we will use but the simplest of model and give references to a number of texts on plasticity for a more detailed analysis.

Plastic work can be estimated from a knowledge of the applied stress and the resulting strain fields. For example for any arbitrary loading, say in the  $x, y, z$  reference frame, mechanics texts write an expression for a work increment per unit volume in terms of stress ( $\sigma$  and  $\tau$ ) and strain increments ( $d\varepsilon$  and  $d\gamma$ ), as

$$dw = \sigma_x d\varepsilon_x + \sigma_y d\varepsilon_y + \sigma_z d\varepsilon_z + \tau_{xy} d\gamma_{xy} + \tau_{xz} d\gamma_{xz} + \tau_{yz} d\gamma_{yz} \quad (20)$$

In principle, to obtain the plastic work of deformation one would integrate this equation over the incremental strains as the deformation evolved.

A good, relatively simple manufacturing example of this would be the case of orthogonal machining of an ideal elastic-plastic material. The stress – strain behavior of an elastic-plastic material is shown in Figure 5 for a tension test.

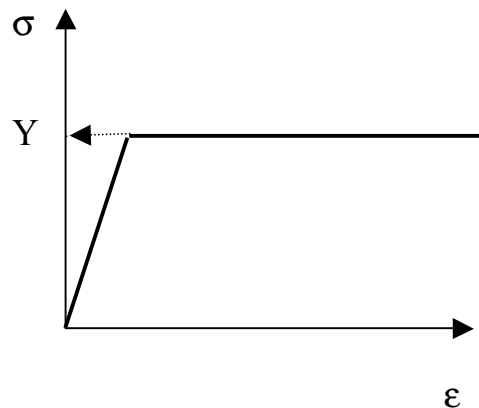

Figure 5 Stress – strain behavior for an idealized elastic-plastic material in a tension test.

At the critical stress  $Y$  the material yields and extends without strain hardening.

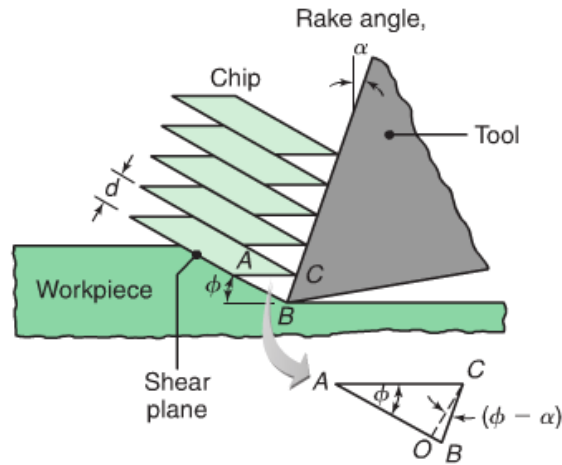

Figure 6 Idealized orthogonal machining, taken from [37].

An idealized model for orthogonal machining can be built using the representation in figure 6 above. Here we conceive of this situation as a system with the material initially undeformed, and then sheared in a narrow zone at shear angle  $\phi$  due to a tool with rake angle  $\alpha$ . The resultant plastic work per unit volume of material sheared,  $w$ , then is due to only one term in equation (19) as

$$\int dw = \int \tau d\gamma \quad (21)$$

where the dimensions of  $\tau$  are for stress (force/area) and  $\gamma$  are for strain (length/length).

The yield stress in shear can be obtained by transforming the tension test result, as  $\tau = Y/2$ . The shear strain can be estimated from a knowledge of the rake and shear angles but generally is in the range of  $2 \leq \gamma \leq 4$  for positive rake angles [48]. Using the value of  $\gamma = 3$  this gives

$$w_{plastic} \cong \frac{3}{2}Y \quad (22)$$



The actual machining process involves significant friction at the tool – work piece interface such that the actual work requirement is considerably more than the calculated plastic work [32, 48, 49]. This work is provided by the spindle motor of the machine tool and is tabulated for various work piece materials as the so called specific cutting energy,  $u_s$ . Comparisons for various common work pieces and cutting conditions show that as a rough approximation  $w_{plastic} / u_s \cong \frac{1}{2}$ .

Typical values for  $u_s$  are given in the table below adapted from Kalpakjian and Schmid assuming incompressible deformation [32].

Table 1 (Adapted from Kalpakjian & Schmid [37])

Approximate Range of Exergy Requirements ( $u_s$ ) in Cutting Operations at the Drive Motor of the Machine Tool

Material	Specific Energy kJ/kg
Aluminum alloys	140-360
Cast irons	140-690
Copper alloys	160-360
High temperature alloys	380-940
Magnesium alloys	170-340
Nickel alloys	570-800
Refractory alloys	290-880
Stainless steels	250-625
Steels	260-1150
Titanium alloys	440-1100

In some cases, materials processing in manufacturing involves steps which may be characterized as a change of state of a closed system [36]. In such cases, no material flow takes place across the system boundary, i.e., the processing assumes a fixed quantity of matter exposed to a change of state. If one considers a non-insulated closed system, the change of physical exergy  $Ex$ , in a given period of time  $t$ , would be

$$\Delta Ex = \sum_{i=1}^n \int_{t_1}^{t_2} \left[ \left(1 - \frac{T_o}{T_i}\right) \frac{dQ_i}{dt} \right] dt - \int_{t_1}^{t_2} \left( \frac{dW}{dt} \right) dt + \rho_o \int_{t_1}^{t_2} \left( \frac{dV}{dt} \right) dt - T_o \int_{t_1}^{t_2} \left( \frac{dS_{irr}}{dt} \right) dt \quad (23)$$

Where  $\Delta Ex = Ex(t = t_2) - Ex(t = t_1)$  represents the exergy difference and  $Ex = [(U + E_k + E_p) - U_o] + p_o(V - V_o) - T_o(S - S_o)$  the exergy in a given state vs. the reference state  $(T_o, p_o)$ . Equation (23) is an integrated exergy balance equation for a closed system in its rate form.<sup>10</sup> Let us consider a fixed mass of a material as a system exposed to an elastic and subsequently plastic deformation. The initial state (at time  $t_1$ ) of a material is exposed to an action of forces that deform the material in presence of uniaxial tensile stresses only. Temperature of the system at which the heat dissipation reaches surroundings is assumed to be virtually the same as the environment. Furthermore, we assume that material density does not change, therefore for the fixed mass the volume of the system does not change either. The change of state during elastic deformation would be fully reversible, and the term signifying corresponding irreversibility would be equal to zero. So, the exergy change during elastic deformation would be equal to the work of elastic deformation but it would be fully recoverable. In the case of further plastic deformation, we will assume that the thermal state would be restored to the initial state, so the corresponding exergy change would be zero, hence the irreversible work invested into the process would be equal to the mechanical work of plastic deformation. As a result, only the work term in Eq (23) would survive.

With the above listed assumptions, the exergy change required to execute elastic and/or plastic deformation would be proportional to the integral of the stress vs. strain relationship for the given material, i.e.,  $w \sim \int \sigma d\varepsilon$ . The total amount of energy resources used would be dependent on the type and mass of material of the system and the ultimate strain achieved.

The results of calculations of exergy utilization are summarized in Table 2. The calculation has been performed for actual stress-strain relationships of the selected materials .

Table 2 Exergy use (order of magnitude) for elastic/plastic deformation

System (includes alloys)	Aluminum	Cooper	Magnesium	Steel	Titanium
Specific exergy use elastic, kJ/kg	$10^{-3} - 10^0$	$10^{-3} - 10^{-1}$	$10^{-1} - 10^0$	$10^{-2} - 10^0$	$10^{-1} - 10^0$
Specific exergy use (from zero load until fracture), kJ/kg	$10^1 - 10^2$	$10^1 - 10^2$	$10^0 - 10^1$	$10^{-1} - 10^1$	$\sim 10^1$

In fig. 7 a schematic representation of the exergy use for achieving either reversible or irreversible deformation is presented on a stress – strain diagram. Note that significant exergy use for achieving the required effect is mostly dissipated in form of thermal energy virtually at the temperature of the environment under assumed conditions, therefore this exergy expenditures are dissipated. Note that elastic deformation is associated with the reversible exergy use and plastic with irreversible [54].

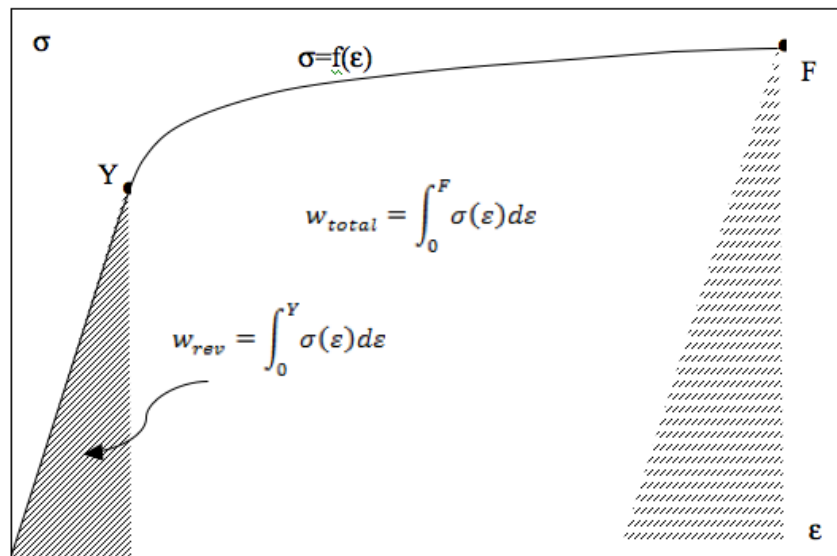

Fig. 7 Reversible (elastic) and irreversible (plastic) exergy use.

## ELECTRICAL WORK (EXERGY) USED IN MANUFACTURING PROCESSES

Here we will look at the actual electrical work used in manufacturing processes. In general, manufacturing processes are made up of a series of processing steps, which for high production situations are usually automated. For some manufacturing processes many steps can be integrated into a single piece of equipment. A modern milling machine, for example, can include a wide variety of functions including work handling, lubrication, chip removal, tool changing, and tool break detection, all in addition to the basic function of the machine tool, which is to cut metal by plastic deformation. The result is that these additional functions can often dominate energy resources requirements at the machine. This is shown in Figure 8 for an automotive machining line (29, 35). In this case, the maximum energy resources requirement for the actual machining in terms of electricity is only 14.8% of the total. Note that this energy rate represents an entity that is recognized in Thermodynamics as a rate of work interaction. At lower production rates the machining contribution is even smaller. Other processes exhibit similar behaviour. See for example data for microelectronics fabrication processes as provided by Murphy (6). Thiriez shows the same effect for injection molding (20, 21). In general, there is a significant energy resources requirement to start-up and maintain the equipment in a “ready” position. Once in the “ready” position, there is then an additional requirement which is proportional to the quantity of material being processed. This situation is modelled in Equation 24.

$$\dot{W} = \dot{W}_o + km \quad (24)$$

where  $\dot{W}$  = total work rate (power) used by the process equipment, in Watts;  $\dot{W}_o$  = “idle” power for the equipment in the ready position, in Watts;  $m$  = the rate of material processing in mass/time; and  $k$  = a constant, with units of Joules/mass.

Note that the total power used by the process may alternately be presented as the exergy rate that corresponds to the electrical work rate. Hence, this equation is directly related to equation (5) for the work rate  $\dot{W}$ . Note that with a model for the reversible work, one could directly calculate the lost exergy  $T_o \dot{S}_{irr}$  by comparing equations (5) and (24).

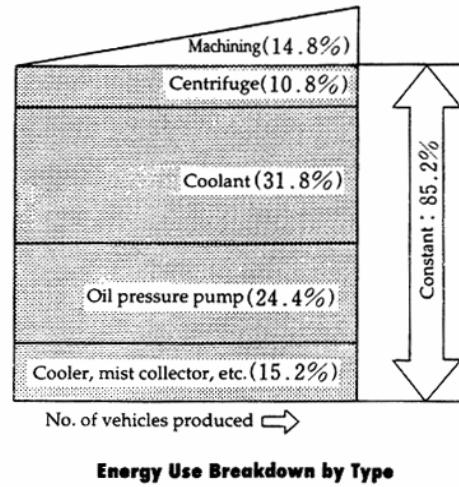

Figure 8: Electrical work rate used as a function of production rate for an automobile production machining line [35].

The specific electrical work per unit of material processed,  $w$ , in units of Joules/mass, is then

$$w = \frac{\dot{W}_o}{\dot{m}} + k \quad (25)$$

This corresponds to the specific or intensive work input (exergy) used by a manufacturing process. In general, the term  $\dot{W}_o$  comes from the equipment features required to support the process, while  $k$  comes from the physics of the process. For example, for a cutting tool  $\dot{W}_o$  comes from the coolant pump, hydraulic pump, computer console and other idling equipment, while  $k$  is the specific cutting work which is closely related to the work piece hardness, the specifics of the cutting mechanics, and the spindle motor efficiency. For a thermal process,  $\dot{W}_o$  comes from the power required to maintain the processing environment at the proper temperature, while  $k$  is related to the incremental input required to raise the temperature of a unit of product, this is proportional to the material heat capacity, temperature increment and the enthalpies of any phase changes that might take place.

We have observed that the electrical power requirements of many manufacturing processes are actually quite constrained, often in the range 5 to 50 kW. This happens for several reasons related to electrical and design standards, process portability, and efficiency. On the other hand, when looking over many different manufacturing processes, the process rates can vary by 10 orders of magnitude. This suggests that it might be possible to collapse the specific electrical work requirements for these processes versus process rate on a single log–log plot. We have done this, and in fact the data do collapse, as shown in Figure 9 for 26 different manufacturing processes. What we see is that the data are essentially contained between four lines. The lower diagonal at 5kW and the upper at 50kW bound most of the data for the advanced machining processes and for the micro and nano processes. The horizontal lines are meant to indicate useful references for the physical constant  $k$ . The lower one at 1 MJ/kg is approximately equal to  $c_{ave}(T_{melt} - T_{room}) + h_{sf}$  for either aluminium or iron. The work to plastically deform these metals, as in milling and machining represented by the so called “Specific Energy” would lie just below this line (see Table 1). The upper horizontal line includes additional terms required to vaporize these metals. Somewhat surprisingly, nearly all of the data we have collected on a rather broad array of manufacturing processes, some of them with power requirements far exceeding 50 kW, are contained within these four lines. In the “diagonal region”, the behavior is described by the first term on the right hand side of Eq. (25). At about 10 kg/hr there is a transition to a more constant work requirement, essentially between 1 – 10 MJ/kg. This group includes processes with very large power requirements. For example, the electric induction melters use between 0.5 to 5 MW and the cupola uses approximately 28 MW power. Note that the cupola is powered by coke combustion and not electricity, hence the power was calculated based upon the exergy difference between the fuel inputs and residue outputs at  $T_o, p_o$  according to Eqs. (5) and (6). This difference includes any exergy losses during the process.

The processes at the bottom right of the diagram in Fig. 9, between the horizontal lines, are the older, more conventional manufacturing processes such as machining, injection molding and metal melting for casting. At the very top left of the diagram we see newer, more recently developed processes with very high values of electric work per unit of material processed. The thermal oxidative processes (shown for two different furnace configurations) can produce very thin layers of oxidized silicon for semiconductor devices. This process, which is carried out at elevated temperatures, is based upon oxygen diffusing through an already oxidized layer and

therefore is extremely slow (6). The other process at the top (EDM drilling) can produce very fine curved cooling channels in turbine blades by a spark discharge process (35). Fortunately, these processes currently do not process large quantities of material and therefore represent only a very small fraction of electricity used in the manufacturing sector.

In the central region of the figure are many of the manufacturing processes used in semiconductor manufacturing. These include sputtering, dry etching, and several variations on the chemical vapour deposition process (CVD). While these are not the highest on the plot, some versions of these processes do process considerable amounts of materials. For example, the CVD process is an important step in the production of electronic grade silicon (EGS) at about 1GJ/kg. Worldwide production of EGS now exceeds 20,000 metric tons, resulting in the need for at least 20PJ of electricity (31). Notice also that recent results for carbon nano-fibers are also in the same region (12). These fibers are being proposed for large scale use in nano-fiber composites. Furthermore, carbon nano-tubes, and single walled nano-tubes (SWNT) generally lie well above the nano-fibers – at least one order of magnitude (44), and possibility as much as two orders of magnitude or more (11, 45). Hence it should not be thought that these very exergy intensive processes only operate on small quantities of materials and therefore their total electricity usage is small. In fact, in some cases it is the opposite that is true.

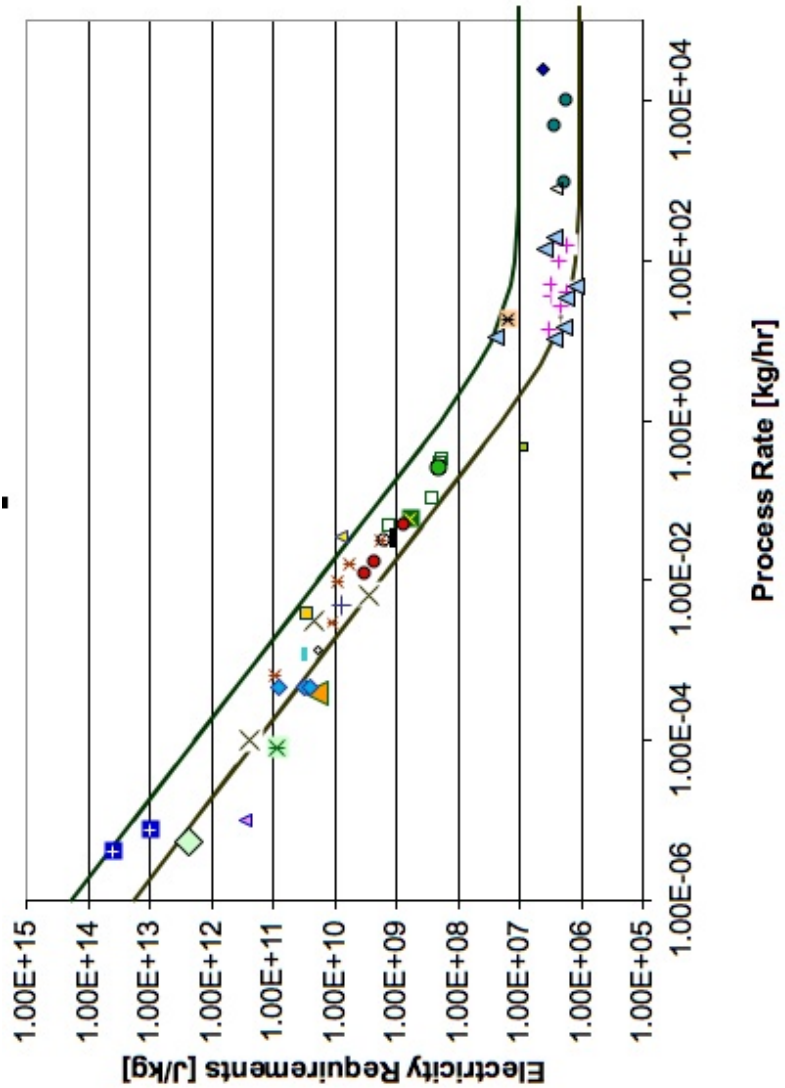



Figure 9: Work in the form of electricity used per unit of material processed for various manufacturing processes as a function of the rate of materials processing.

When considering the data in Figure 9, keep in mind that an individual process can move up and down the diagonal by a change in operating process rate. This happens, for example, when a milling machine is used for finish machining versus rough machining, or when a CVD process operates on a different number of wafers at a time.

Note also that the data in Fig. 9 may require further modification in order to agree with typical estimates of energy resources consumption by manufacturing processes given in the Life Cycle Assessment literature. For example, the data for injection molding, given by Thiriez (20), averages about 3 MJ/kg. At a grid efficiency of 30% this yields a specific energy value of 10 MJ/kg. However, most injection molding operations include a variety of additional sub-processes such as extrusion, compounding, and drying, all of which add substantially to the energy totals. If these additional pieces of equipment are also included, they result in a value for injection molding of about 20 MJ/kg which agrees with the Life Cycle literature (14, 15, 20). Additionally, the data in Fig. 9 do not include facility level air handling and environmental conditioning, which for semiconductors can be substantial (28).

## EXERGY EFFICIENCY OF MANUFACTURING PROCESSES

The figure of merit of resources use in terms of exergy in a process to which a system is exposed assumes two prerequisite analysis steps to be completed. The first would be the definition of the system and the second writing the conservation or balance equation. As formulated earlier, see Eq. (7) and Fig. 2 the system  $\Omega$  is defined quite generally and its exergy interactions marked. It is assumed that  $n$  material streams,  $\dot{m}_{in,i}$  (including auxiliary streams), each carrying total exergy  $\dot{E}x_i$ , ( $i = 1, n$ ), enter at the system inlets. In general, these streams may not be at the restricted dead state, so they may have both physical and chemical exergy components. Within the system the material streams participate in the process and are transformed into the product and the waste streams by the help of energy interactions, work  $\dot{W}$ , or in exergy terms  $\dot{E}x^W$ ; heat transfers  $\dot{Q}$ , or in exergy terms  $\dot{E}x^Q$  delivered at the temperature  $T \neq T_o$ , and heat transfer loss  $\dot{Q}_o$  at  $T_o$ , or in ex-

ergy terms  $\dot{E}x^{Q_0} = 0$ . The product material stream  $\dot{m}^{product}$  carries, in general, both physical and chemical exergy, the total of which is  $\dot{E}x^{product}$ , while m material streams include waste and/or auxiliary material stream,  $\dot{E}x_j^{waste}$ , ( $j = 1, m$ ). The exergy balance for this system states that total exergy in,  $\dot{E}x^{in}$  that includes material exergies, work exergy and heat transfer exergies must be equal to the exergy of the product, the exergy losses (due to the waste streams and heat loss at the temperature of the environment, and the exergy destruction within the system,  $\Delta\dot{E}x^{destruct}$ . This situation is shown in Fig 10, below. After applying Eq. (7), the steady state balance becomes

$$\dot{E}x^{in} = \sum_{i=1}^n \dot{E}x_i + \dot{E}x^W + \dot{E}x^Q = \dot{E}x^{product} + \sum_{j=1}^m \dot{E}x_j^{waste} + \dot{E}x^{Q_0} + \Delta\dot{E}x^{destruct} \quad (26)$$

Based on this balance equation, we define the figure of merit as a coefficient of resources use performance (this coefficient should not be confused with a coefficient of performance defined in Thermodynamics for refrigeration cycles and heat pumps). We define this figure of merit as the ratio of the exergy rate value of the product (the first term in Eq. (26) on the RHS of the second equality, and the total exergy rate input into the system, the LHS in Eq. (26). That is,

$$\eta_p = \frac{\dot{E}x^{product}}{\dot{E}x^{in}} = \frac{\dot{E}x^{in} - (\sum_{j=1}^m \dot{E}x_j^{waste} + \dot{E}x^{Q_0} + \Delta\dot{E}x^{destruct})}{\dot{E}x^{in}} = 1 - \frac{\sum_{j=1}^m \dot{E}x_j^{waste} + \Delta\dot{E}x^{destruct}}{\dot{E}x^{in}} \quad (27)$$

Note that Eq. (26) takes two limiting values, i.e.

$$\eta_p = \frac{\dot{E}x^{product}}{\dot{E}x^{in}} = \begin{cases} 0 \text{ if } \dot{E}x^{product} = 0 \\ 1 \text{ if } \sum_{j=1}^m \dot{E}x_j^{waste} + \Delta\dot{E}x^{destruct} = 0 \end{cases} \begin{cases} \sum_{j=1}^m \dot{E}x_j^{waste} = 0, \text{ i. e., no waste} \\ \text{and} \\ \Delta\dot{E}x^{destruct} = 0, \text{ i. e., rev. process} \end{cases} \quad (28)$$

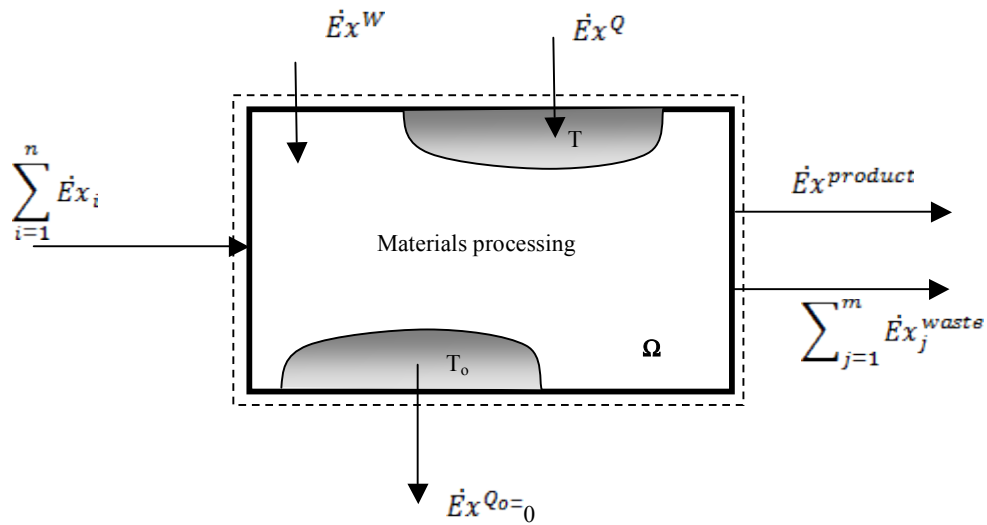

Fig. 10 Materials processing/manufacturing system

*Special case: Resource Accounting*

Consider the definition of the exergy efficiency of a manufacturing process as defined in equations 27 and 28. This is identical to the so-called Degree of Perfection as given by Szargut [5]. In these equations there is an exergy value for waste,  $\sum \dot{E}x^{waste} > 0$ . This represents an aggregated exergy equivalent of the material and possible other energy output streams. The materials streams may have both physical as well as chemical exergy. If this term is large it represents an opportunity to reduce this value and thereby improve the efficiency of the process. It also could represent an opportunity to recapture these resources and to improve the performance of an extended system which would now include the original process plus the recapturing process. Practical examples of the first kind of efficiency improvement would be to reduce the cutting fluid used in a machining process, or to insulate a furnace. Examples of the second kind would be to recycle the cutting fluid used in machining, or to use waste enthalpy potential to preheat incoming materials.

In a special subset of exergy accounting, as distinct from traditional thermal engineering analysis, one can be concerned primarily with how much exergy resources are used and ultimately lost

and/or recaptured to perform various manufacturing operations. In this context, the term “lost” may include an additional value system, not only thermodynamic based on exergy balancing. For example, consider a material stream of a residue of an intentionally destructive process that cannot be used regardless of the possibility of having non-zero exergy. To account for this kind of situation, we introduce an accounting scheme, which we will refer to as Resource Accounting. This scheme is developed for the purpose of comparing alternative manufacturing processes. In this scheme, one would ask the question, “what normally happens to the waste material”? For example, if it is recaptured, such as in recycling, then one could reconsider the waste term as a product or a co-product. On the other hand, if it is disposed of in some way such that it becomes unavailable for use, it might be considered lost. This difference is important if one wants to identify the resources lost as a consequence of a manufacturing process.

Often, the most important form of physical exergy that is lost in the material output of a manufacturing process is the thermal component of it. In many cases, materials, both product and residues, exit a manufacturing process at an elevated temperature. However, for a large group of manufacturing processes, such as the kind analyzed here, this physical exergy is seldom captured. In almost every case it is dissipated to the environment. Hence for resource accounting the physical exergy is lost as the materials outputs are equilibrated with environmental conditions at  $T_o, p_o$ . In fact for this accounting scheme we will generally consider that all materials enter and exit at their standard chemical exergy at  $T_o, p_o$ .

As far as chemical exergy is concerned, there are a number of processes that eventually recapture the residue materials and recycle them. A variety of machining processes such as turning and milling would fall in this category. At the same time, however, there is a large group of manufacturing processes that produce wastes that are not recaptured. In fact, in some cases waste materials may be destroyed purposefully to render them passive in the environment. In other cases material residues are directly dissipated to the environment, and in some cases are land filled where they may or may not be exploited in the future. In resource accounting we are concerned about these outcomes and want to include these outcomes in the analysis. In particular, we intend to address here those cases where the output material exergy becomes unavailable and eventually

destroyed beyond the manufacturing process subsystem boundaries. To do this, one could imagine a post process subsystem similar to the subsystems as drawn in Figure 1. This new subsystem would use the residue or the waste output from the manufacturing process as an input and reduce it to its ultimate state. This post process then could be analyzed in a similar manner to how we have analyzed the manufacturing process. After all, it is another version of a materials transformation process. A simple example could help to illustrate this point. Consider the case of hot iron cuttings from a machining operation which are subsequently cooled and deposited to the ground and due to natural action eventually oxidize and become diluted in the soil at  $T_o, p_o$ . A second example could be a process that produces a waste stream of vaporized aluminum which oxidizes, cools and is dispersed in the environment at  $T_o, p_o$ . These exergy losses are calculable. In both of these cases mentioned here the waste exergy (aggregate physical and chemical) is reduced by over 99% as it goes through the post-process subsystem we use to represent their usual treatment. And still further losses can incur with increasing dilution and/or possible reactions with the environment. Hence by a variety of processes both industrial and natural, the residue or waste materials can ultimately be reduced to, or very near to, the ultimate dead state. While there are indeed nuances to this description, there are so many manufacturing processes that produce waste materials which are not recaptured, are degraded in the environment, and are most likely lost for ever, that this needs to be addressed in order to account for resources lost in these processes. As a result, when analyzing a manufacturing process for Resource Accounting, one needs to include a post process subsystem(s) combined with the manufacturing process to address the issue of the ultimate fate of the material wastes. Of course, for this combined analysis any additional inputs and/or outputs used for the post process subsystems must also be included in the analysis. However, for natural processes these inputs are often small in exergy value if not zero. One of the most important is oxygen for oxidation. However, oxygen could enter the post-process subsystem as standard average atmospheric air with close to zero exergy. Keep in mind that the materials themselves are not lost. Their mass is conserved. But their usefulness is destroyed.

This problem becomes particularly poignant for a special class of manufacturing processes that remove material from a work piece in a destructive manner. This rather large class of manufacturing processes would include such processes as laser machining, electrical discharge machin-

ing, ion beam machining, plasma and chemical etching processes and still many more. In these cases of extended resource accounting, when the material system to be analyzed is necessarily focused on the material to be removed, it becomes difficult if not impossible to identify a product at the output. The goal of the process is to produce a hole where the material used to be. There is no suitable positive bulk exergy at the output to be identified as the product. Hence, the resulting reduced balance equation is essentially;  $\dot{E}x^{in} \cong \dot{E}x^{lost}$ , and it may become questionable to use the previous definition of efficiency. Note that in this interpretation we define as a system only the material to be removed and lost, that is any possible material flow that passes through the process as not removed and lost, is not included so that the above statements becomes valid. This may raise a question of an interaction of the considered process with this excluded reminder of the “unaffected” material flow. In other words, the material balance is preserved and residue just passes through the process setting, however, in principle, may gain or lose certain exergy due to an interaction with the process exerted on the material to perform the destruction.

In spite of the fact that these destructive removal processes do not fit our traditional framework for the exergy analysis of manufacturing processes, there are several ways one might construct an efficiency metric to measure their exergetic use of resources. For example, one could identify a portion of the exergy lost as equal to the exergy of the removed material. This would constitute the goal of the process; to remove and reduce to zero this exergy.

We can form the balance equation for an idealized version of a destructive removal process in a manner similar to equation (26). In this case, the input flow exergy is confined to the material to be removed  $\dot{E}x_{mr}$  and any other input material that is destroyed within the process or ultimately lost in the extended boundary version of the process  $\dot{E}x_{mo}$ . Other materials that transit through the system with their chemical exergy intact are not included. At the same time we recognized that these very same materials may and often do interact with the process most notably by a change in their physical exergy. But these very same effects are ultimately lost as the work piece and/or auxiliary materials are equilibrated with the environmental at  $T_o, p_o$ , resulting in a loss. By this device all inputs are ultimately lost. On the RHS of the balance equation we only differentiate between the exergy lost associated with the identified material to be removed  $\dot{E}x_{mr}^{lost}$ , and eve-

rything else, which is  $\dot{E}x_{other}^{lost}$ . Here we do not distinguish internal and external destruction, but simply label exergy that is ultimately lost as such. Hence the balance equation for this case would be

$$\dot{E}x^{in} = \dot{E}x_{mr} + \dot{E}x_{mo} + \dot{E}x^W + \dot{E}x^Q = \dot{E}x_{mr}^{lost} + \dot{E}x_{other}^{lost} \quad (29)$$

We form the exergy efficiency of destructive removal processes,  $\eta_{DR}$  then as the ratio,

$$\eta_{DR} = \frac{\dot{E}x_{mr}^{lost}}{\dot{E}x^{in}} = 1 - \frac{\dot{E}x_{other}^{lost}}{\dot{E}x^{in}} \quad (30)$$

This metric,  $\eta_{DR}$  takes on a value of 1 when all losses are confined to the material to be removed. In practice,  $\eta_{DR}$  can be quite small (approaching zero, i.e.  $< 10^{-3}$ ) for real processes. This will be demonstrated in the next section.

## EXPERIMENTAL DATA FOR EXERGETIC EFFICIENCY OF MANUFACTURING PROCESSES

The three processes to be considered here can all be found on Fig. 9. They include electric induction melting of iron [26] near the lower right hand section of the figure, plasma enhanced chemical vapor deposition (PECVD) of  $S_iO_2$  [28], much higher on the figure, and dry etching of  $S_iO_2$  [28] in between the two previous examples. In each case, we collect data on the input materials and electricity, convert them to exergy values, aggregate and then compare them with the “product” or the “identified material to be removed” as given in equations (27) and (30). The

results are given in Tables 3, 4, and 5. One can see immediately that the difference between the conventional process (melting) and the semi conductor processes is enormous, nearly six orders of magnitude. For the case of melting one can see that the exergy inputs are dominated by the exergy of the working material (gray iron). For the semi conductor processes we see two interesting effects. First and foremost is the dominance of the electricity input. But in addition, one sees that the exergy of the auxiliary materials used in semiconductor manufacturing is also very large. In fact for these two cases the exergy of the input materials alone is two to four orders of magnitude larger than the product output or the identified material to be removed. For example, in Table 4 for PECVD, one sees that the exergy of the input cleaning gases alone is more than four orders of magnitude greater than the product output. Furthermore, these gases have to be treated to reduce their reactivity and possible attendant pollution. If this is done using combustion with methane, the exergy of the methane alone can exceed the electricity input (10, 29). When still other manufacturing processes are analyzed, one finds that while the degree of perfection is generally in the range of 0.05 to 0.8 for conventional processes, the range for semiconductor processes is generally in the range of  $10^{-4}$  to  $10^{-6}$ . Note that this analysis uses only the direct inputs and outputs to the manufacturing system given as  $\Omega_{MF}$  in Figure 1. Hence, the exergy cost of extraction and purifying the inputs, which would be captured in the system  $\Omega_{MA}$  in Figure 1, is not included in this analysis.



Table 3 Exergy Analysis of an Electric Induction Melting Furnace [26]

<b>Electric Induction Melting</b>		
<b>Input Materials</b>		
<i>Inputs</i>	<i>Mass (kg)</i>	<i>Exergy (MJ)</i>
Scrap Metal- lics	0.68	5.08
Cast Iron Remelt	0.30	2.51
Additives	0.05	1.13
<b>Input Energy</b>		
Electricity		1.72
	<i>Total In</i>	10.43
<b>Useful Output</b>		
Gray Iron Melt	1.0	8.25
	<i>Total Out</i>	8.25
<b>Degree of Perfection (<math>\eta_P</math>)</b>		<b>0.79</b>

Table 4 Exergy Analysis of a Plasma Enhanced Chemical Vapor Deposition Process for an Undoped Oxide Layer [28]

<b>PECVD of Silicon Dioxide</b>				
<b>Input Deposition Gases</b>				
<i>Inputs</i>	<i>Mass (g)</i>	<i>Mols</i>	<i>Specific Chemical Exergy (kJ/mol)</i>	<i>Exergy (kJ)</i>
N2	276.3	9.86	0.69	6.80
SiH4	8.57	0.267	1383.7	369.4
N2O	440.6	10.01	106.9	1,070.2
<b>Input Cleaning Gases</b>				
O2	69.09	2.16	3.97	8.57
C2F6	298.0	2.16	962.4	2,078.1
<b>Input Energy</b>				
Electricity				50,516
	<i>Total In</i>			54,049
<b>Output</b>				
Undoped Silicon Dioxide Layer	1.555	2.59E-02	7.9	0.204
	<i>Total Out</i>			0.204
<b>Degree of Perfection (<math>\eta_P</math>)</b>				<b>3.78E-06</b>

Table 5 Exergy Analysis of Dry Etching Process for SiO<sub>2</sub> [28]

<b>Dry Etching of a Silicon Dioxide Film (Full Process)</b>				
<b>Input Materials</b>				
Inputs	Mass (g)	Mols	Specific Chemical Exergy (kJ/mol)	Exergy (kJ)
Ar	4.18	1.05E-01	11.69	1.22
CHF <sub>3</sub>	0.378	5.4E-03	569.0	3.07
CF <sub>4</sub>	0.389	4.42E-03	454.1	2.01
SiO <sub>2</sub>	0.067	1.12E-03	7.90	8.86E-03
<b>Input Energy</b>				
Electricity				5565
Total In				5571
<b>Output</b>				
Etched SiO <sub>2</sub>	0.067	1.12E-03	7.90	8.86E-03
Total Out				8.86E-03
<b>Exergetic Efficiency of Removal (<math>\eta_{DR}</math>)</b>				1.59E-06

Before closing this section we would like to re-emphasize that there are many ways in which one can construct a measure of efficiency. Each is done for a specific system and purpose, and one should be careful not to interpret the results in any context other than the intended.

## CLOSING COMMENTS

In this chapter we develop a thermodynamic framework for analyzing manufacturing processes. This can be used in several ways, but perhaps the most important are 1) for the identification of

losses and inefficiencies in a process, which can be used to direct attention to potential areas of improvement, and 2) in the area of resource accounting, for example as one would do in life cycle assessment. In fact the principles presented in this chapter are not new, but the application of thermodynamics to manufacturing processes, as the ones discussed here, is indeed relatively new. We suspect that this area will receive more attention, particularly as concerns about energy and global warming rise.

Note that the information in Figure 9 provides a kind of chronological tour through new manufacturing process development. In general, new process development proceeds from the lower right to the upper left in that figure. For example, note that processes such as machining and casting date back to the beginning of last century and long before, while the semi-conductor processes were developed mostly after the invention of the transistor (1947), and the nano-materials processes have come even more recently. The more modern processes can work to finer dimensions and smaller scales, but also work at lower rates, resulting in very large specific electrical work requirements. In addition to these trends in increased electricity use per unit of material processed, we also saw in our last three examples the increased use of high exergy auxiliary materials in manufacturing. In general, the auxiliary materials are used in the manufacturing process, but do not get incorporated into the final product.

One should note that the systems considered in manufacturing processes differ vastly from the systems used in energy processes (where energy conversion, and thus energy efficiency of a process, are of ultimate importance). In all our cases, the material processed is considered as a thermodynamic system, but the primary useful effect has been beyond the energy resource use scope. The product and its quality have marginalized considerations of energy resources (as well as the impact on the environment). With much more prominent concerns regarding resources use in the context of sustainable development these issues must be reconsidered. An adoption of thermodynamics methods for such analysis may still poses a certain level of inadequacy when perceived in the same context as for energy systems (e.g., the dramatic difference in magnitudes – and meaning – of efficiencies), but we are convinced that these will find an increasing use, al-

though possibly after additional streamlining of the metrics to better reflect the trans-disciplinary aspects of resources utilization.

A particular example of the development of carbon nanotubes can be used to illustrate how this general trend in increased energy resources and exergy use for manufacturing has come to be. As shown earlier, carbon nanotubes are one of the most energy intensive materials humankind has produced. Yet, the cost of this energy turns out to be only a very small fraction of the price. For example, say the energy cost for making carbon nanotubes is on the order of 36GJ of electricity per kilogram or 36MJ/g. This is equal to 10 kWh/g. Now at 7 cents a kilowatt hour this yields a cost of 70 cents per gram. But carbon nanotubes can sell for around \$300/g. In other words, the electricity cost in this case is on the order of 0.2% of the price, and according to a recent cost study, energy costs for all manufacturing processes for nanotubes result in about 1% of the cost. [45]. It appears that new manufacturing processes can produce novel products with high demand resulting in a value that far exceeds the energy resources (electricity) cost. At the same time however, since our current electricity supply comes primarily from fossil fuels, most of the environmental impacts associated with these materials (e.g. global warming, acidification, mercury emissions) are related to this use of electricity [45]. How can we reconcile this inconsistency? One comment would be that the current price for carbon nanotubes may well be inflated due to the rather substantial government funds for nanotechnology research worldwide. Another comment, of course, is that, from an environmental perspective, electricity from fossil fuels is significantly underpriced. That is, the environmental and health externalities associated with the use of fossil fuels are not included in the price of electricity.

These trends, in Fig. 9 and Tables 3, 4 and 5 however, do not give the whole story for any given application. New manufacturing processes can improve, and furthermore can provide benefits to society and even to the environment by providing longer life and /or lower energy required in the use phase of products. Furthermore, they may provide any number of performance benefits, and/or valuable services that cannot be expressed only in energy/exergy terms. Nevertheless, the seemingly extravagant use of materials and energy resources by many newer manufacturing

processes is alarming and needs to be addressed alongside claims of improved sustainability from products manufactured by these means.

## REFERENCES

- [1] Gyftopoulos, E.P.; Beretta, G.P. *Thermodynamics: Foundations and Applications*; Dover Publications, Inc., New York, New York, U.S.A., 2005.
- [2] Bejan, A. *Advanced Engineering Thermodynamics*; Third Edition, John Wiley and Sons, 2006.
- [3] de Swaan Aarons, J.; van der Kooi, H.; Shankaranarayanan, K. *Efficiency and Sustainability in the Energy and Chemical Industries*; Marcel Dekker Inc., New York, NY, U.S.A., 2004.
- [4] Sato, N. *Chemical Energy and Exergy – An Introduction to Chemical Thermodynamics for Engineers*; Elsevier, 2004.
- [5] Szargut, J.; Morris, D.R.; Steward, F.R. *Exergy Analysis of Thermal Chemical and Metallurgical Processes*, Hemisphere Publishing Corporation and Springer-Verlag, New York, NY, USA., 1988.
- [6] Murphy, C.F.; Kenig, G.A.; Allen, D.; Laurent, J.-P.; Dyer, D.E.; Development of parametric material, energy, and emission inventories for wafer fabrication in the semiconductor industry, *Environmental Science & Technology*, 2003, 37 (23): 5373-5382.
- [7] Williams, E.D.; Ayres, R.U.; Heller, M.; The 1.7 kilogram microchip: energy and material use in the production of semiconductor devices. *Environmental Science and Technology*, 2002, 36: 5504-5510.
- [8] Krishnan, N.; Raoux, S.; Dornfield, D.A. Quantifying the environmental footprint of semiconductor equipment using the environmental value systems analysis (EnV-S). *IEEE Transaction on Semiconductor Manufacturing*, 2004, 17 (4), 554-561 (Postprint).
- [9] Zhang, T.W.; Boyd, S.; Vijayaraghavan, A.; Dornfeld, D. Energy use in nanoscale manufacturing. In *IEEE International Symposium on Electronics and the Environment*, 8-11 May, San Francisco, California, U.S.A., 2006.

- [10] Boyd, S.; Dornfeld, D.; Krishnan, N. Lifecycle inventory of a CMOS chip. In IEEE International Symposium on Electronics and the Environment, 8-11 May, San Francisco, California, U.S.A., 2006.
- [11] Issacs, J.A.; Tanwani, A.; Healy, M.L. Environmental assessment of SWNT production. In IEEE International Symposium on Electronics and the Environment, 8-11 May, San Francisco, California, U.S.A. 2006.
- [12] Khanna, V.; Bakshi, B.; Lee James L. Carbon nanofiber production; life cycle energy consumption and environmental impacts. *Journal of Industrial Ecology*, 2008, Vol. 12,( 3), 394-410.
- [13] Morrow, W.M., Qi. H., Kim, I., Mazumder, J., Skerlos, S.J., 2007, "Environmental Aspects of Laser Based Tool and Die Manufacturing", *Journal of Cleaner Production*, Vol. 15 pp. 932-943
- [14] Boustead, I. Eco-profiles of the European plastics industry: PVC conversion processes, APME, Brussels, Belgium 2002. Visited: 25 Feb. 2005  
<[http://www.apme.org/dashboard/business\\_layer/template.asp?url=http://www.apme.org/media/public\\_documents/20021009\\_123742/EcoProfile\\_PVC\\_conversion\\_Oct2002.pdf](http://www.apme.org/dashboard/business_layer/template.asp?url=http://www.apme.org/media/public_documents/20021009_123742/EcoProfile_PVC_conversion_Oct2002.pdf)>
- [15] Boustead, I. Eco-profiles of the European plastics industry: Conversion processes for polyolefins, APME, Brussels, Belgium, 2003. Visited: 25 Feb.2005  
<[http://www.apme.org/dashboard/business\\_layer/template.asp?url=http://www.apme.org/media/public\\_documents/20040610\\_153828/PolyolefinsConversionReport\\_Nov2003.pdf](http://www.apme.org/dashboard/business_layer/template.asp?url=http://www.apme.org/media/public_documents/20040610_153828/PolyolefinsConversionReport_Nov2003.pdf)>
- [16] Munoz, A.; Sheng, P. An analytical approach for determining the environmental impact of machining processes. *Journal of Materials Processing Technology*, 1995 vol. 53, 736-758.
- [17] Mattis, J.; Sheng, P.; DiScipio, W.; and Leong, K. A framework for analyzing energy efficient injection-molding die design. University of California, Berkeley, Engineering Systems Research Center Technical Report, 1996.
- [18] Dahmus, J.; Gutowski, T. An environmental analysis of machining, In ASME International Mechanical Engineering Congress and RD&D Exposition, Anaheim, California, U.S.A., November 13-19, 2004.

- [19] Dalquist, S.; Gutowski, T. Life cycle analysis of conventional manufacturing techniques: sand casting, In ASME International Mechanical Engineering Congress and RD&D Exposition, Anaheim, California, U.S.A., November 13-19, 2004.
- [20] Thiriez, A. An environmental analysis of injection molding. Massachusetts Institute of Technology, Project for M.S. Thesis, Department of Mechanical Engineering, Cambridge, MA, U.S.A., 2005.
- [21] Thiriez, A.; Gutowski, T. An environmental analysis of injection molding. IEEE International Symposium on Electronics and the Environment, San Francisco, California, U.S.A., May 8-11, 2006.
- [22] Baniszewski, B. An environmental impact analysis of grinding. Massachusetts Institute of Technology, B.S. Thesis, Department of Mechanical Engineering, Cambridge, MA, U.S.A. 2005.
- [23] Kurd, M. The material and energy flow through the abrasive waterjet machining and recycling processes. Massachusetts Institute of Technology, B.S. Thesis, Department of Mechanical Engineering, Cambridge, MA. U.S.A. 2004.
- [24] Cho, M. Environmental constituents of electrical discharge machining. Massachusetts Institute of Technology, B.S. thesis, Department of Mechanical Engineering, Cambridge, MA., U.S.A., 2004.
- [25] Kordonowy, D.N., A power assessment of machining tools. Massachusetts Institute of Technology, B.S. Thesis, Department of Mechanical Engineering. Cambridge, MA, U.S.A., 2001.
- [26] Jones, A. The industrial ecology of the iron casting industry. Massachusetts Institute of Technology, M.S. Thesis, Department of Mechanical Engineering, Cambridge, MA., U.S.A., 2007.
- [27] Branham, M.; Gutowski, T.; Sekulic, D. A thermodynamic framework for analyzing and improving manufacturing processes., In IEEE International Symposium on Electronics and the Environment, San Francisco U.S.A., May 19-20, 2008
- [28] Branham, M. Semiconductors and sustainability: energy and materials use in the integrated circuit industry. Department of Mechanical Engineering, M.I.T. MS Thesis, 2008.



- [29] Gutowski, T.; Dahmus, J.; Branham, M.; Jones, A. A thermodynamic characterization of manufacturing processes. In IEEE International Symposium on Electronics and the Environment, Orlando, Florida, U.S.A., May 7-10, 2007.
- [30] Gutowski, T.; Murphy, C.; Allen, D.; Bauer, D.; Bras, B.; Piwonka, T.; Sheng, P.; Sutherland, J.; Thurston, D.; Wolff, E. Environmentally benign manufacturing: observations from Japan, Europe and the United States, *Journal of Cleaner Production*, 2005, 13: 1-17.
- [31] Luque, A.; Lohne, O. *Handbook of photovoltaic science and engineering*, John Wiley, 2003.
- [32] Kalpakjian, S.; Schmid, S.R. *Manufacturing engineering and technology*. Sixth Edition, Prentice Hall, Upper SaddleRiver, New Jersey, U.S.A., 2010.
- [33] Morrow, W.R.; Qi, H.; Kim, I.; Mazumder, J.; Skerlos, S.J. Laser-based and conventional tool and die manufacturing: comparison and environmental aspects. Proceedings of Global Conference on Sustainable Product Development and Life Cycle Engineering, 29 September - 1 October, 2004, Berlin, Germany.
- [34] Wolf, S.; Tauber, R.N. *Silicon processing for the VLSI era*. Volume 1 – Process Technology, Lattice Press, Sunset Beach, CA., U.S.A., 1986.
- [35] McGeough, J.A., *Advance methods of machining*. Chapman and Hall, New York, NY., U.S.A. 1988.
- [36] Sekulic, D. P, An entropy generation metric for non-energy systems assessments, *Energy*, Vol. 34, 2008, pp. 587-592
- [37] Jayasankar, S, Exergy Based Method for Sustainable Energy Utilization of a Net Shape Manufacturing System, MS Thesis, University of Kentucky, Mechanical Engineering Department, Lexington, KY, 2005.
- [38] Sekulic, D.P., and Jayasankar, S., Advanced Thermodynamics Metrics for Sustainability Assessments of Open Engineering Systems, *Thermal Science*, Vol. 10, No. 1, 2006, pp. 125-140.
- [39] Boddapati, V.S., Exergy based metrics for assessment of manufacturing processes sustainability, MS Thesis, University of Kentucky, Mechanical Engineering Department, Lexington, KY, 2006

- [40] Subramaniam, S and Sekulic, D.P. Balancing Material and Exergy Flows for a PCB Soldering Process: Method and a Case Study, IEEE Int. Symp. On Sustainable Systems and Technology, May 16-19, 2010, Washington, D.C.
- [41] Flemings, M.C., Solidification Processing, McGraw Hill Series in Materials Science and Engineering, 1974.
- [42] Kal Reganathan Sharma, Nanostructuring Operations, McGraw-Hill, 2010
- [43] Michael J. Bronikowski, Peter A. Willis, Daniel T. Colbert, K.A. Smith and Richard E. Smalley, "Gas-phase production of carbon single-walled nanotubes from carbon monoxide via the HiPco process: A parametric study", *J. Vac. Sc. Technol. A* 19(4), pp. 1800-1805, American Vacuum Society, Jul/Aug. 2001
- [44] Gutowski, T.G., J.Y.H. Liow and D.P. Sekulic, Minimum Exergy Requirements for the Manufacturing of Carbon Nanotubes, paper to be presented at IEEE/ISSST 2010.
- [45] Meagan L. Healy, Lindsay J. Dahlben and Jacqueline A. Isaacs, "Environmental Assessment of Single-Walled Carbon Nanotube Processes", *Journal of Industrial Ecology*, Vol. 12, No. 3, pp.376-393, June 2008.
- [46] Abrahamson, J, "The Surface Energies of Graphite", *Carbon*, Vol. 11, No. 4-E, pp. 357-362, Pergamon Press, 1975.
- [47] Lu, Qiang and Rui Huang, "Nonlinear Mechanics of Single-Atomic-Layer Graphene Sheets", *International Journal of Applied Mechanics*, Vol. 1. No. 3, pp. 443-467, Imperial College Press, 2009.
- [48] Cook, N.H., Manufacturing Analysis, Addison Wesley Publishing Co., Inc. 1966.
- [49] Hill, R., The Mathematical Theory of Plasticity, The Oxford Engineering Science Series, Oxford University Press, 1950.
- [50] Gutowski, T.G., Branham, M.S., Dahmus, J.B., Jones, A.J., Thiriez, A., and Sekulic, D.P., Thermodynamic Analysis of Resources Used in Manufacturing Processes *Environmental Science and Technology* Vol. 43, pp. 1584-1590, 2009.
- [51] Aceves-Saborio, S., Ranasinghe, J., Reistad, G., An Extension to the Irreversibility Minimization Analysis Applied to Heat Exchangers, *Journal of Heat Transfer*, Vol. 111, 1989, pp.29-37

- [52] P. Su, A. Gerlich, T. H. North and G. J. Bendzsak, Energy utilisation and generation during friction stir spot welding, *Science and Technology of Welding and Joining* 2006, Vol. 11, No 2, pp. 163-169.
- [53] Szargut, J. Egzergia, Wydawnictwo Politechniki Śląskiej, Gliwice, 2007 (in Polish)
- [54] Avallone, E.A., Baumeister, T., Sadegh, A., Mark's Standard Handbook for Mechanical Engineers, 11th ed., McGraw Hill, NY., 2007.

---

<sup>1</sup> This chapter is based in large part on a paper that appeared in *Environmental Science and Technology* (43, 1584-90, 2009) entitled "Thermodynamic Analysis of Resources Used in Manufacturing Processes", by Timothy G. Gutowski, Matthew S. Branham, Jeffrey B. Dahmus, Alissa J. Jones, Alexandre Thiriez, and Dusan Sekulic. New material has been added in several places, especially on the calculation of the minimum work for manufacturing processes.

<sup>2</sup> Note that the exergy losses involve not only exergy of the energy flows but also the exergy of the material flows.

<sup>3</sup> For discussion of mass, energy, entropy and exergy balances see Chapter 2.

<sup>4</sup> Detailed discussion of the physical meaning and a formal structure of this physical quantity is provided in Chapters 1 and 2 of this volume. In the text that follows, only the main features of exergy will be discussed.

<sup>5</sup> Refer to Chapter 2 and the Appendix for a more detailed list of references.

<sup>6</sup> This is equivalent to the consideration of a system that would have extended boundary so that material flows enter and leave the system at the state of environment. This brings all intermediate interactions into the considered system. Further discussion on this topic can be found in the section on exergy efficiency in this chapter.

<sup>7</sup> The term "destruction" associated with systems change of state is often denoted as "loss". For the sake of clarity, we use the term "destruction" to signify internal irreversibilities, and "loss" to mark external losses.

<sup>8</sup> A more general interpretation of the importance of these extrema for transformational technologies development is discussed in Chapter 5.

<sup>9</sup> For details of the physical meaning of the availability function see Chapters 1 and 2.

<sup>10</sup> Refer to Eq. (4) in this chapter and the material given in Chapter 2.