

TetGen

A Quality Tetrahedral Mesh Generator and Three-Dimensional Delaunay Triangulator

Version 1.4

User's Manual

January 18, 2006

Hang Si

si@wias-berlin.de

<http://tetgen.berlios.de>

©2002, 2004, 2005, 2006

Abstract

TetGen generates tetrahedral meshes and Delaunay tetrahedralizations. The tetrahedral meshes are suitable for finite element and finite volume methods. The algorithms implemented are the state of the art.

This document briefly explains the problems solved by TetGen and is a detailed user's guide. Readers will learn how to create tetrahedral meshes using input files from the command line. Furthermore, the programming interface for calling TetGen from other programs is explained.

keywords: tetrahedral mesh, Delaunay tetrahedralization, constrained Delaunay tetrahedralization, mesh quality, mesh generation

Contents

1	Introduction	5
1.1	Delaunay Triangulation and The Convex Hull	5
1.2	Constrained Delaunay Tetrahedralization	8
1.2.1	Piecewise Linear Complex	12
1.3	Quality Tetrahedral Mesh	13
1.3.1	The Radius-Edge Ratio Quality Measure	14
2	Getting Started	16
2.1	Compilation	16
2.1.1	Unix/Linux	16
2.1.2	Windows 9x/NT/2000/XP	17
2.2	Testing	17
2.3	Visualization	20
2.3.1	TetView	20
2.3.2	Other Mesh Viewers	21
3	Using TetGen	22
3.1	Command Line Syntax	22
3.2	Command Line Switches	22
3.2.1	-p Tetrahedralizes a PLC	24
3.2.2	-q Quality mesh generation	24
3.2.3	-a Imposes volume constraints	25
3.2.4	-A Assigns region attributes	25
3.2.5	-r Reconstructs/refines a mesh	25
3.2.6	-i Inserts additional points	26
3.2.7	-T Sets a tolerance	27
3.2.8	-Y Prohibit Steiner Points on Boundary	27
3.2.9	Other Switches	27
3.3	Command Line Examples	28
3.3.1	Generate Delaunay tetrahedralizations	28
3.3.2	Generate Constrained Delaunay tetrahedralizations	28
3.3.3	Mesh Quality, Mesh Size Control	29
4	File Formats	31
4.1	TetGen File Formats	31
4.1.1	.node files	31
4.1.2	.poly files	32
4.1.3	.smesh files	36
4.1.4	.ele files	37

4.1.5	.face files	38
4.1.6	.edge files	38
4.1.7	.vol files	39
4.1.8	.var files	39
4.1.9	.neigh files	40
4.2	Supported File Formats	40
4.2.1	.off files	41
4.2.2	.ply files	41
4.2.3	.stl files	41
4.2.4	.mesh files	42
4.3	File Format Examples	42
4.3.1	A PLC with Two Boundary Markers	42
4.3.2	A PLC with Two Regions	45
5	Calling TetGen from Another Program	48
5.1	The Header File	48
5.2	The Calling Convention	48
5.3	The “tetgenio” Data Type	49
5.4	Description of Arrays	50
5.4.1	Memory Management	51
5.4.2	The “facet” Data Structure	52
5.5	An Example	54
A	Some Combinatorial Topology	58
	References	59

1 Introduction

The TetGen program generates tetrahedral meshes from three-dimensional domains. The goal is to generate suitable tetrahedral meshes for numerical simulation using finite element and finite volume methods. Besides, as a tetrahedral mesh generator, it can be used as a meshing component in many scientific and engineering applications.

For a three-dimensional domain, defined by its boundary (such as a surface mesh), TetGen generates the boundary constrained (Delaunay) tetrahedralization, conforming (Delaunay) tetrahedralization, quality (Delaunay) mesh. The latter is nicely graded and the tetrahedra have circumradius-to-shortest-edge ratio bounded. For a three-dimensional point set, the Delaunay tetrahedralization and convex hull are generated.

The code, written in C++, may be compiled into an executable program or a library for integrating into other applications. All major operating systems, e.g. Unix/Linux, MacOS, Windows, etc, are supported.

The algorithms used in TetGen are of Delaunay type. The remainder of this section is to give a brief description of the mesh problems that TetGen solves. The algorithms implemented in TetGen are described. References are given for people who are particularly interesting in these approaches. However, this information is not really crucial for all users. Most of the sections can be skipped but Section 1.2.1 and 1.3.1, which contain some important points to get a solvable problem.

1.1 Delaunay Triangulation and The Convex Hull

The Delaunay triangulation of a vertex set, introduced by Delaunay [1] in 1934, has many favorable properties which make it be a useful geometric structure. It has been used extensively both in the design of efficient algorithms and in practical applications.

The language of combinatorial topology will be used to describe Delaunay triangulations. Understanding of some basic notions is necessary, such as convex hull, simplex, simplicial complex. A brief explanation of these notions is provided in Appendix A.

Let V be a set of vertices, s be a k -simplex ($0 \leq k \leq n$) formed from vertices of V . The *circumsphere* of s is a sphere that passes through all vertices of s . If $k = d$, s has a unique circumsphere, otherwise, there are infinitely many circumspheres of s . The simplex s is *Delaunay* if there exists a circumsphere of s such that no vertex of V lies inside it. Figure 1 (a) shows Delaunay simplices in a set of two-dimensional vertices.

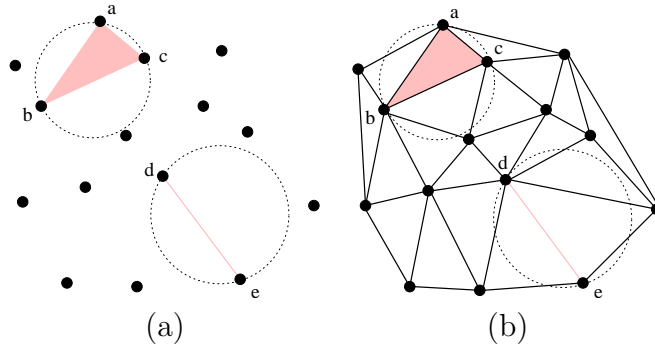

Figure 1: The Delaunay criterion and Delaunay triangulation in two dimensions. **(a)** Both the 2-simplex abc and the 1-simplex de are Delaunay. **(b)** The corresponding Delaunay triangulation of the point set shown in (a).

The *Delaunay triangulation* \mathcal{D} of V is a simplicial complex consisting of Delaunay simplices, and the set of all simplices of \mathcal{D} covers the convex hull of V . A two-dimensional Delaunay triangulation is illustrated in Figure 1 (b). In three dimensions, it is also called *Delaunay tetrahedralization*.

A Delaunay triangulation in \mathbf{R}^d corresponds to a convex hull in \mathbf{R}^{d+1} . For point $p = (p_1, p_2, \dots, p_d) \in \mathbf{R}^d$, define its *lift point* $p^+ = (p_1, p_2, \dots, p_d, p_{d+1}) \in \mathbf{R}^{d+1}$, where $p_{d+1} = \sum_{i=1}^d p_i^2$. For a point set $V \subset \mathbf{R}^d$, define $V^+ = \{p^+ \mid p \in V\}$. V^+ is the set of points “lifted” from points of V in \mathbf{R}^d and on a paraboloid in \mathbf{R}^{d+1} (see Figure 2 (a)). Then the convex hull $\text{con}(V^+)$ is a $d + 1$ -dimensional convex polytope. The Delaunay triangulation of V can be produced by projecting $\text{con}(V^+)$ into d dimensions. Figure 2 illustrates the relationship when $d = 2$. For this reason, convex hull algorithms [18, 13] can be used to generate Delaunay triangulations.

In fact, a Delaunay triangulation is one of *regular triangulations*, or equivalently *weighted Delaunay triangulations* [23]. Such triangulations are related to convex polytopes [20] which makes them interesting in three or higher dimensional combinatorial structures [39]. Recent research shows that they’re effective in removing slivers in quality mesh generation [33, 34].

The Delaunay triangulation has many optimal properties. For example, among all triangulations of a set of points in \mathbf{R}^2 , it maximizes the minimum angle, and also minimizes the maximum circumradius; optimal time complexity algorithms (divide-and-conquer and plane-sweep) are known. A discussion on some optimal properties of the Delaunay triangulation in three or higher dimensions can be found in [16]. In the following, we introduce two properties which are both useful in numerical methods and the design of efficient algorithms.

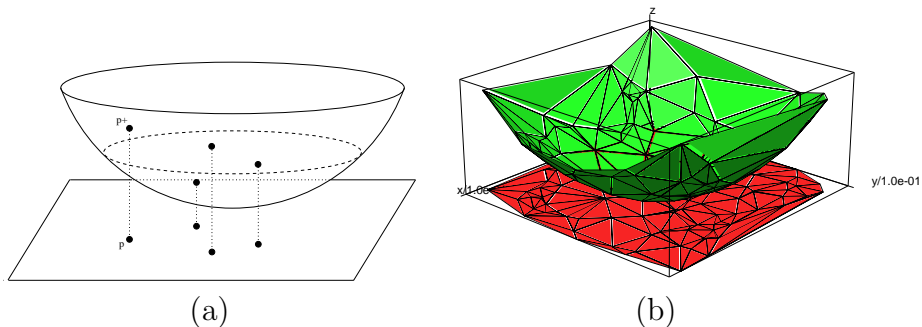

Figure 2: The relation between Delaunay triangulation in \mathbf{R}^d and convex hull in \mathbf{R}^{d+1} (here $d = 2$). **(a)** Some 2D points and their corresponding 3D lift points. **(b)** The Delaunay triangulation of a set of 2D points and the lower convex hull of its 3D lifted points.

The dual of the Delaunay triangulation is the Voronoi diagram defined on the same vertex set. For any vertex $a \in V$, the *Voronoi cell* of a is the set of points with distance to a not greater than to any other vertex of V , i.e. it is the set $\{x \in \mathbf{R}^n \mid |x - a| \leq |x - b|, \forall b \in V\}$, where $|\cdot|$ stands for the Euclidean distance. The *Voronoi diagram* of V is a subdivision of space \mathbf{R}^n into Voronoi cells (some of which may be unbounded). Delaunay triangulation and Voronoi diagram are geometrically dual. For example, in two dimensions, Voronoi polygons correspond to Delaunay vertices, Voronoi edges correspond to Delaunay edges, and Voronoi vertices correspond to Delaunay triangles (illustrated in Figure 3 (a)).

Another useful property is the localization of the Delaunay property. Let \mathcal{T} be an arbitrary triangulation of V , and s be a simplex of \mathcal{T} . Let \mathcal{K} be a subcomplex of \mathcal{T} formed by simplices containing s . s is *locally Delaunay* if there exists a circumsphere of s enclosing no vertices from the vertex set of \mathcal{K} in its interior. Figure 3 (b) illustrates the property in two dimensions. Evidently, if every simplex of \mathcal{T} is locally Delaunay, then \mathcal{T} is Delaunay triangulation.

It is well known that the Delaunay triangulations can be constructed by “flips”. A *flip* is an operation to transform a set of non-locally Delaunay simplices into another set of simplices which are locally Delaunay. Figure 4 illustrates two types of flips in three dimensions. The basic idea of flip-based algorithms is relatively simple: start from an arbitrary triangulation, flip simplices that are not locally Delaunay, until all simplices are locally Delaunay. The result is a Delaunay triangulation due to the fact mentioned above. Lawson [5] first used a flip algorithm to construct two-dimensional

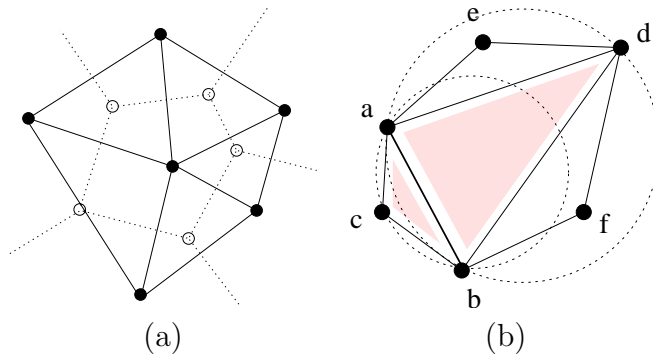

Figure 3: Properties of Delaunay triangulations. **(a)** The relation between Delaunay triangulation and Voronoi diagram. **(b)** Locally Delaunay property. Edge ab is locally Delaunay. Here only c and d affect the property because there are triangles abc and abd sharing edge ab . e and f are excluded from the definition of the property.

Delaunay triangulations. However, in dimension higher than two, such simple scheme may not terminate (see the discussion in [10]). Nevertheless, it has been proved [10] that Delaunay tetrahedralizations can be constructed by incremental insertion of points and flips.

For a three-dimensional point set (number of points ≥ 4), TetGen generates its exact Delaunay tetrahedralization and convex hull. The convex hull is represented in a set of triangular faces. The flip-based algorithm TetGen uses is from Edelsbrunner and Shah [22]. It is incremental and adds points in a sequence of flips. The algorithm has time complexity $O(n^2)$ in the worst case. However, such case will rarely happen. In practice, this algorithm has a nearly linear complexity.

Our implementation is fast and robust. On a 3.06GHz, Intel Computer, TetGen computes the Delaunay tetrahedralization of 40,000 randomly distributed points in 4.8 seconds. It used 3 minutes to compute the Delaunay tetrahedralization for 1 million points. The robustness is achieved by the use of the adaptive exact arithmetic [25] code for performing two geometric predications, i.e., orientation and insphere tests.

1.2 Constrained Delaunay Tetrahedralization

A *constrained tetrahedralization* is a decomposition of a three-dimensional domain Ω into a tetrahedral mesh, such that the boundary $\partial\Omega$ is presented in the faces of the mesh. Generally, Ω may be arbitrarily complicated in shape, contain internal boundaries (separating different regions) and holes. This

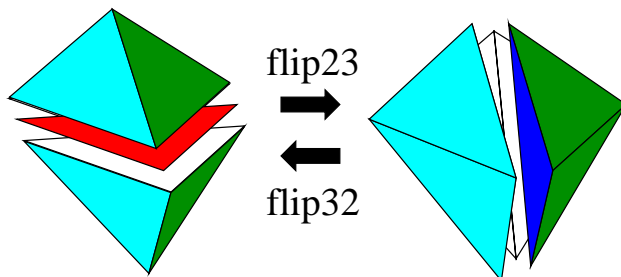

Figure 4: Two flip operations in three dimensions. A 2-to-3 flip replaces a non-locally Delaunay face (the red face on the left figure) into three locally Delaunay faces (the blue and white faces on the right figure); while a 3-to-2 flip does the inverse.

problem is also referred as *boundary mesh generation* or *boundary conformity*.

The Delaunay tetrahedralization of the vertices of Ω does not necessarily conform to $\partial\Omega$ due to faces of $\partial\Omega$ that are non-Delaunay simplices.

A *constrained Delaunay tetrahedralization* (CDT) is a variation of a Delaunay tetrahedralization that is constrained to respect $\partial\Omega$. CDTs maintain many properties of Delaunay tetrahedralizations [7, 29]. They are suitable structures for solving this problem.

For simplifying the design of an algorithm, one can assume $\partial\Omega$ is a three-dimensional polyhedron, i.e., $\partial\Omega$ is the underlying space of a two-dimensional simplicial complex. More specifically, $\partial\Omega$ is a set $V \subset \mathbf{R}^3$ of vertices, and a set of polygons. Each polygon is a segment-bounded constraining facet. TetGen uses a more general representation for $\partial\Omega$ which will be introduced separately in Section 1.2.1.

The following definition of CDT is taken from Shewchuk [31].

The visibility between two vertices p and q of V is *occluded* if there is a constraining polygon f such that p and q lie on opposite sides of the plane that includes f , and the line segment pq intersects this polygon (see Figure 5). A tetrahedron t formed by vertices of V is *constrained Delaunay* if its circumsphere encloses no vertex of V , which is visible from any point in the relative interior of t (see Figure 5).

A tetrahedralization T of $\partial\Omega$ is called *constrained tetrahedralization* if T and $\partial\Omega$ have exactly the same vertex set, and each polygon of $\partial\Omega$ is completely represented by a union of triangular faces of T .

T is a *constrained Delaunay tetrahedralization* of $\partial\Omega$ if it is a constrained tetrahedralization and every tetrahedron of T is constrained Delaunay.

Intuitively, the definitions of Delaunay tetrahedralization and constrained

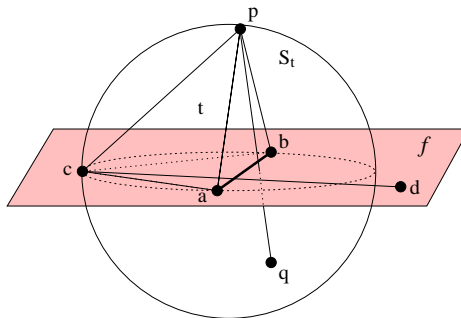

Figure 5: Constrained Delaunay tetrahedron. The shaded region represents a constraining face f of $\partial\Omega$ including vertices a , b , c , and d . Vertices p and q lie on opposite sides of f , they can not see each other. While c and d can see each other even if ab is a segment of f . S_t is the circumsphere of tetrahedron t ($abc p$) and it encloses q but not d - t is constrained Delaunay.

Delaunay tetrahedralization are the same except that, for the CDT, we ignore the volume of a sphere whenever the sphere passes through a constraining polygon. Note that simplices (tetrahedra, triangles, and edges) in a CDT are not always Delaunay.

Constructing CDTs is subtle. Some polyhedra having no tetrahedralization at all [2, 3, 4, 38]. Two examples are shown in Figure 6. Furthermore, Ruppert and Seidel [14] showed that it is NP-complete to decide whether a simple polyhedron can be tetrahedralized or not. Nevertheless, every polyhedron is tetrahedralizable as long as additional points will be inserted. CDT algorithms insert additional vertices. A key question, when such additional points are necessary to ensure the existence, is to decide what is the optimal (minimal) number of additional points. Another concern, mainly for mesh refinement algorithms, is to avoid very short edges, which endanger very small tetrahedra, hence the number of additional points can be undecidably large. Various approaches [29, 32, 36, 37, 41] based on different point insertion schemes for CDTs have been proposed.

Shewchuk gave a condition [26] that guarantees the existence of CDTs, which is useful for designing algorithms to construct CDTs. Because each polygon of $\partial\Omega$ is segment-bounded. One considers the set of all segments of $\partial\Omega$. A segment s is Delaunay if there exists a circumsphere S of s , such that no vertices of $\partial\Omega$ lies inside S . Furthermore, s is *strongly Delaunay* if no vertices of $\partial\Omega$ lie inside or on S . The condition is if all segments of $\partial\Omega$ are strongly Delaunay, then the CDT of $\partial\Omega$ exists. This condition is useful because it suggests that the additional points can be inserted on segments

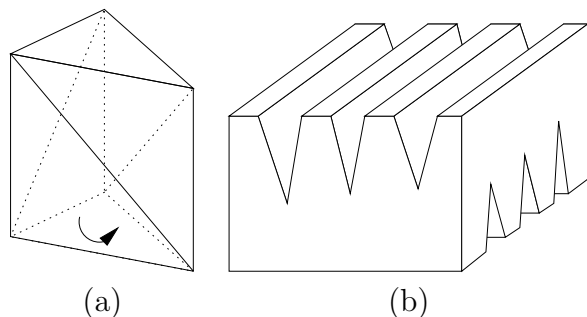

Figure 6: Two polyhedrons which can not be tetrahedralized. **(a)** The Schönhardt polyhedron, which is formed by rotating one end of a triangular prism, resulting in three non-convex diagonal edges. **(b)** The Chazelle's polyhedron, which can be built out of a cube by cutting deep wedges.

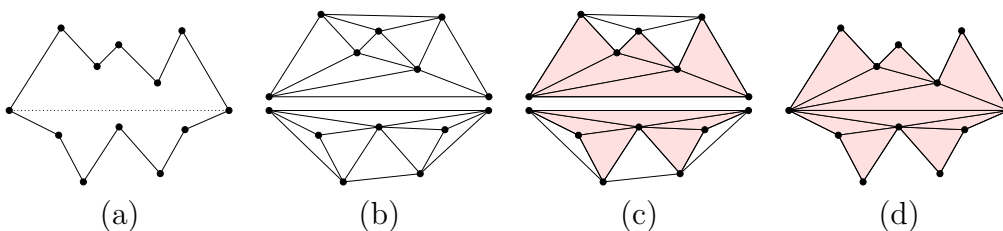

Figure 7: Cavity triangulation (illustrated in 2D). **(a)** Two initial cavities separated by a constraining segment. **(b)** The two Delaunay triangulations are constructed at each side of the segment. **(c)** Mark triangles as “inside” or “outside”. **(d)** Remove “outside” triangles.

only.

The algorithm that TetGen implemented is described in Si and Gärtner [42]. This algorithm extends the segment recovery algorithm proposed in [41]. The main difference from other CDT algorithms [29, 30, 41] is the practical exploitability of a strong CDT existence condition which requires no *local degeneracy* in the set of vertices of $\partial\Omega$. A new local degeneracy removal algorithm combining vertex perturbation and vertex insertion is used to construct a new set of vertices which is consistent with $\partial\Omega$. After the condition is satisfied, a practically fast facet recovery algorithm is used to construct the CDT. Figure 7 shows the main idea of this algorithm in 2D.

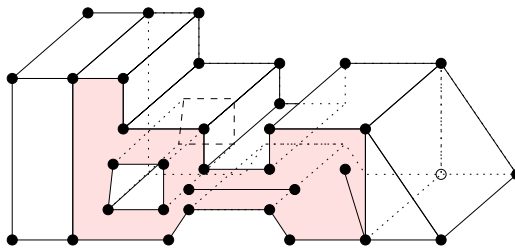

Figure 8: A piecewise linear complex, which is a set of vertices, and a set of segments and facets. The shaded area shows a facet which is non-convex, has a hole, segments and vertices in it.

1.2.1 Piecewise Linear Complex

Three-dimensional geometric objects are often more complicated than polyhedra, TetGen uses a more general input called *piecewise linear complex* (PLC), defined by Miller, Talmor, Teng, Walkington, and Wang [19]. A PLC X is a set of vertices, segments and *facets* (see Figure 8). Each facet is a polygonal region, it may have any number of sides and may be non-convex, possibly with holes, segments and vertices in it. A facet can represent any *planar straight line graph* (PSLG), which is a popular input model used by many two-dimensional mesh algorithms. A facet is actually a PSLG embedded in three dimensions. An example is given in Figure 8, the shaded area highlights a facet.

PLCs have restrictions like any other complex. For a PLC X , the elements of X must be closed under intersection. For example, two segments only can intersect at a common vertex which is also in X . Two facets of X may intersect only at a shared segment or vertex or a union of shared segments and vertices (because facets are non-convex). Figure 9 shows non-closed configurations for examples.

Another restriction of the facets of PLCs is that the point set which used to define a facet must be coplanar.

Any polyhedron is a PLC. Furthermore, PLCs are more flexible than polyhedra to represent three-dimensional geometric objects. For example, the shaded facet in Figure 8 can not be represented by any polygon. For domains having curved surfaces (which are not piecewise linear), the surface triangulations are previously required, hence, PLCs can approximately represent any three-dimensional domain.

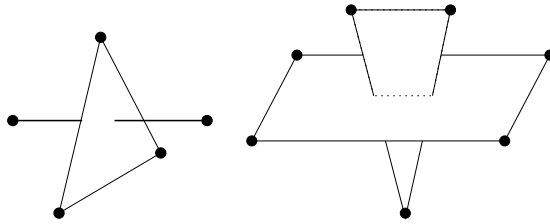

Figure 9: Some invalid PLCs. Left: one vertex is missing; right: two vertices and one segment are missing.

1.3 Quality Tetrahedral Mesh

TetGen creates tetrahedral meshes suitable for solving *partial differential equations* (PDEs) by *finite element methods* (FEM) and *finite volume methods* (FVM).

The problem is to generate a tetrahedral mesh conforming to a given (polyhedral or piecewise linear) domain together with certain constraints for the size and shape of the mesh elements. It is a typical problem of *provably good mesh generation* or *quality mesh generation*. The techniques of quality mesh generation provide the “shape” and “size” guarantees on the meshes:

- all elements have a certain quality measure bounded, and
- the number of elements is within a constant factor of the minimum number.

The approaches to solve quality mesh generation include octree [35, 11], advancing front [12, 21], and Delaunay methods [6, 27, 28, 24, 40, 34].

Delaunay refinement, a Delaunay tetrahedralization is refined by iteratively adding vertices. The placement of these vertices is chosen to enforce boundary conformity and to improve the quality of the mesh. Delaunay refinement was successfully applied to the corresponding two-dimensional problem. Such algorithms can be found in the work of Chew [8, 9], and Ruppert [15]. However, these algorithms in three dimensions do not remove slivers (very flat and nearly degenerate tetrahedra).

The algorithm TetGen implemented to tackle this problem is a Delaunay refinement algorithm from Shewchuk [27]. It is a smooth generalization of Ruppert’s algorithm to three dimensions. Given a complex of vertices, constraining segments and facets in three dimensions, with no input angle less than 90° , this algorithm can generate a quality mesh of Delaunay tetrahedra with radius-edge ratios (see section 1.3.1) not greater than 2.0. Tetrahedra

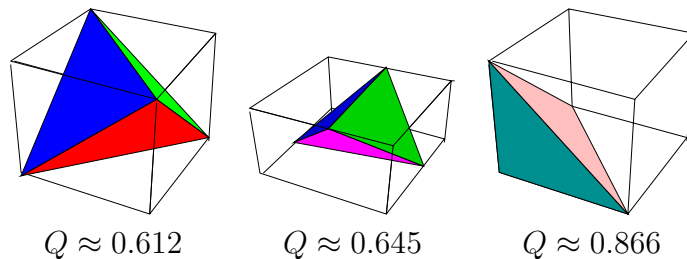

Figure 10: The radius-edge ratios of some well-shaped tetrahedra.

are graded from small to large over a short distances. The algorithm generates meshes generally surpassing the theoretical bounds and is effectively in eliminates tetrahedra with small or large dihedral angles.

Except the tetrahedra near small input angles, the sliver is the only type of badly-shaped tetrahedron which could survive after the Delaunay refinement. Several techniques [6, 33, 24] have been developed to remove slivers from the mesh. TetGen does a simplified sliver removal step. Slivers are removed by local flip operations and peeling off from the boundary. This strategy is effective to remove most of the slivers but does not guarantee to remove all of them. Methods mentioned above are worth to implement in the future.

1.3.1 The Radius-Edge Ratio Quality Measure

There are several quality measures available in literature. This section explains the quality measure used in TetGen due to the algorithm [27] it implements.

For accuracy in the FEM, it is generally necessary that the shapes of elements have bounded aspect ratio. The *aspect ratio* of an element is the ratio of the maximum side length to the minimum altitude. For a quality mesh, this value should as small as possible. For example, “thin and flat” tetrahedra tend to have large aspect ratio.

A similar but weaker quality measure is radius-edge ratio, proposed by Miller, Talmor, Teng, Walkington, and Wang [17]. A tetrahedron t has a unique circumsphere. Let $R = R(t)$ be that radius and $L = L(t)$ the length of the shortest edge. The *radius-edge ratio* $Q = Q(t)$ of the tetrahedron is:

$$Q = \frac{R}{L}$$

The radius-edge ratio measures the quality of a tetrahedron. For all well-shaped tetrahedra, this value is small (see Figure 10), while for most of badly-shaped tetrahedra, this value is large (see Figure 11). Hence, in a

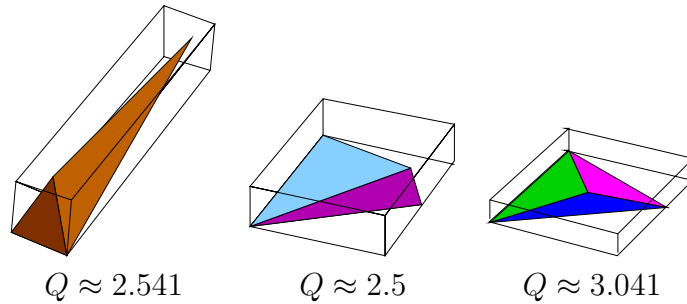

Figure 11: The radius-edge ratios of some badly-shaped tetrahedra.

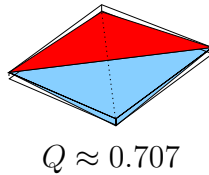

Figure 12: The radius-edge ratios of a sliver.

quality mesh, this value should be bounded as small as possible. However, the ratio is minimized by the regular tetrahedron (in which case the lengths of the six edges are equal, and the circumcenter is the barycenter), that is:

$$Q \geq \sqrt{6}/4 \approx 0.612.$$

A special type of badly-shaped tetrahedron is called *sliver* (see Figure 12), which is very flat and nearly degenerate. Slivers can have radius-edge ratio as small as $\sqrt{2}/2 \approx 0.707$. The radius-edge ratio is not a proper measure for slivers. However, Miller, Talmor, Teng, Walkington, and Wang [17] have pointed out that it is the most natural and elegant measure for analyzing Delaunay refinement algorithms.

2 Getting Started

The latest version of TetGen is available at <http://tetgen.berlios.de>. TetGen is distributed in its source code (written in C++). It has to be compiled first. The code is highly portable, only the standard C++ libraries are needed. It should be compiled on all major 32-bit and 64-bit computers. Section 2.1 explains how to compile TetGen into an executable program on Unix/Linux and Windows systems.

Once you get the executable file, “tetgen” (or “tetgen.exe” in Windows), you can test TetGen with the included example file by following the tutorial in Section 2.2.

TetGen does not have a graphic user interface (GUI). The *TetView* program can be used to visualize the input and output of TetGen. Alternatively, other popular mesh viewers are supported, see Section 2.3.

2.1 Compilation

The downloaded archive should include the following files:

README	General information.
LICENSE	Copyright notices.
tetgen.h	Header file of the TetGen library.
tetgen.cxx	C++ source code of the TetGen library.
predicates.cxx	C++ source code of the geometric predicates.
makefile	Makefile for compiling TetGen.
example.poly	A sample data file.

File “predicates.cxx” is a C++ version of Shewchul’s exact geometric predicates <http://www.cs.cmu.edu/~quake/robust.html>.

To compile TetGen, use a C++ compiler for the system on which TetGen will be used, such as g++ on Unix/Linux, or Microsoft C++ or Borland C++ on Windows. TetGen may be compiled into an executable program, or a library which can be embedded into another program.

2.1.1 Unix/Linux

The easiest way to compile TetGen is to edit and use the included makefile. Before compiling, put all source files (tetgen.h, tetgen.cxx, and predicates.cxx) and the makefile in one directory (usually they are), read the makefile, which describes your options, and edit it accordingly. You should specify the C++ compiler and the level of optimization.

Once you've done this, type "make" to compile TetGen into an executable program or type "make tetlib" to compile TetGen into a library. The executable file "tetgen" or the library "libtet.a" appears in the same directory as the makefile.

Alternatively, the files are usually easy to compile without a makefile. Assume you're using g++, first compile the file predicates.cxx to get an object file:

```
g++ -c predicates.cxx
```

To compile TetGen into an executable file, use the following command:

```
g++ -O -o tetgen tetgen.cxx predicates.o -lm
```

To compile TetGen into a library, the symbol TETLIBRARY is needed:

```
g++ -O -DTETLIBRARY -c tetgen.cxx  
ar r libtet.a tetgen.o predicates.o
```

2.1.2 Windows 9x/NT/2000/XP

TetGen compiles as a console program "tetgen.exe" or a library "tetgen.lib" on Win32 systems. Tests have been done with Microsoft Visual C++ 6.0 (VC++). The easiest way to compile TetGen is to use the integrated development environment (IDE) of VC++. The minimum steps to create "tetgen.exe" are:

- create a "Win32 console application" called "tetgen",
- add all source files into this project, i.e., tetgen.h, tetgen.cxx, and predicates.cxx
- build the project.

To create a library do the following minimum steps:

- create a "Win32 static library" called "library",
- add all source files into this project,
- add the symbol "TETLIBRARY" to compile switches.
- build the project.

2.2 Testing

TetGen gives a short list of command line options if it is invoked without arguments (that is, just type "tetgen"). A brief description of the usage is printed by invoking TetGen with the -h switch:

```
tetgen -h
```

The enclosed sample file, `example.poly`, is a simple three-dimensional piecewise linear complex (PLC). Try out TetGen using:

```
tetgen -p example
```

TetGen will read this PLC, and write its constrained Delaunay tetrahedralization to files `example.1.node`, `example.1.ele`, and `example.1.face`, which are a list of mesh nodes, a list of tetrahedra, and a list of boundary faces (triangles), respectively. A typical output of TetGen looks like this:

```
Opening example.poly.
Constructing Delaunay tetrahedralization.
Delaunay seconds: 0.02
Creating surface mesh.
Perturbing vertices.
Delaunizing segments.
Constraining facets.
Segment and facet seconds: 0.02
Removing unwanted tetrahedra.
Hole seconds: 0
Repairing degenerate tets.
Steiner seconds: 0

Writing example.1.node.
Writing example.1.ele.
Writing example.1.face.

Output seconds: 0
Total running seconds: 0.04
```

Statistics:

```
Input points: 54
Input facets: 29
Input holes: 0
Input regions: 0

Mesh points: 79
Mesh tetrahedra: 188
Mesh faces: 453
Mesh subfaces: 154
Mesh subsegments: 106
```

To get the quality tetrahedral mesh of this PLC, try:

```
tetgen -pq example
```

The result mesh is contained in the same three files as before. But this time, it is a quality tetrahedral mesh, whose tetrahedra have circumradius-to-shortest-edge ratio bounded by 2.0. Now try to run:

```
tetgen -pq1.414V example
```

TetGen will again generate a quality mesh, which contains more points than previous one, and all tetrahedra have radius-edge ratio bounded by 1.414. In addition, TetGen prints a rough mesh quality report (due to the -V switch). It looks as below:

Mesh quality statistics:

Smallest volume:	0.0085019		Largest volume:	115.27
Shortest edge:	0.30902		Longest edge:	15.287
Smallest dihedral:	5.0167		Largest dihedral:	169.2909

Radius-edge ratio histogram:

< 0.707	:	6		1.6 - 1.8	:	130
0.707 - 1	:	238		1.8 - 2	:	64
1 - 1.1	:	85		2 - 2.5	:	0
1.1 - 1.2	:	94		2.5 - 3	:	0
1.2 - 1.4	:	222		3 - 10	:	0
1.4 - 1.6	:	145		10 -	:	0

(A tetrahedron's radius-edge ratio is its radius of circumsphere divided by its shortest edge length)

Aspect ratio histogram:

1.1547 - 1.5	:	0		15 - 25	:	13
1.5 - 2	:	0		25 - 50	:	3
2 - 2.5	:	0		50 - 100	:	0
2.5 - 3	:	10		100 - 300	:	0
3 - 4	:	209		300 - 1000	:	0
4 - 6	:	607		1000 - 10000	:	0
6 - 10	:	115		10000 - 100000	:	0
10 - 15	:	27		100000 -	:	0

(A tetrahedron's aspect ratio is its longest edge length divided by the diameter of its inscribed sphere)

Dihedral angle histogram:

0 - 5 degrees:	0		90 - 100 degrees:	310
5 - 10 degrees:	25		100 - 110 degrees:	206
10 - 30 degrees:	340		110 - 120 degrees:	173
30 - 40 degrees:	263		120 - 130 degrees:	100
40 - 50 degrees:	251		130 - 140 degrees:	46
50 - 60 degrees:	100		140 - 150 degrees:	23
60 - 70 degrees:	5		150 - 170 degrees:	43
70 - 80 degrees:	4		170 - 175 degrees:	0

80 - 90 degrees: 79 | 175 - 180 degrees: 0

To compute the Delaunay tetrahedralization and convex hull of the point set of this PLC, try this:

```
cp example.poly example.node
tetgen example
```

The Delaunay tetrahedralization is saved in `example.1.node` and `example.1.ele`. The convex hull is represented by a list of triangles in file `example.1.face`.

All these meshes and Delaunay tetrahedralizations can be visualized by the programs introduced in the next section.

Detailed descriptions of the command line switches and file formats are found in Section 3 and 4.

2.3 Visualization

2.3.1 TetView

TetView is a graphic interface for viewing piecewise linear complexes and simplicial meshes. It is specially created for TetGen. It can read the input and output files and display the objects, see Figure 13 for a snapshot. It also shows other informations as well, such as boundary types and materials. The interactive GUI allows the user to manipulate (i.e., rotate, translate, zoom in/out, cut, shrink, etc.) the viewing objects easily through either mouse or keyboard. TetView can save the current window contents into high quality encapsulated postscript files.

TetView is freely available from <http://tetgen.berlios.de/tetview.html>. You will find a list of precompiled executable versions on different platforms. Download the one corresponding to your system.

To show the PLC in `example.poly`, first copy the executable file (`tetview`) to the directory where you have this file, it is loaded by running:

```
tetview example.poly
```

And the following command will display the mesh (in files `example.1.node`, `example.1.ele`, and `example.1.face`):

```
tetview example.1
```

The instruction for using TetView can be found in the above website.

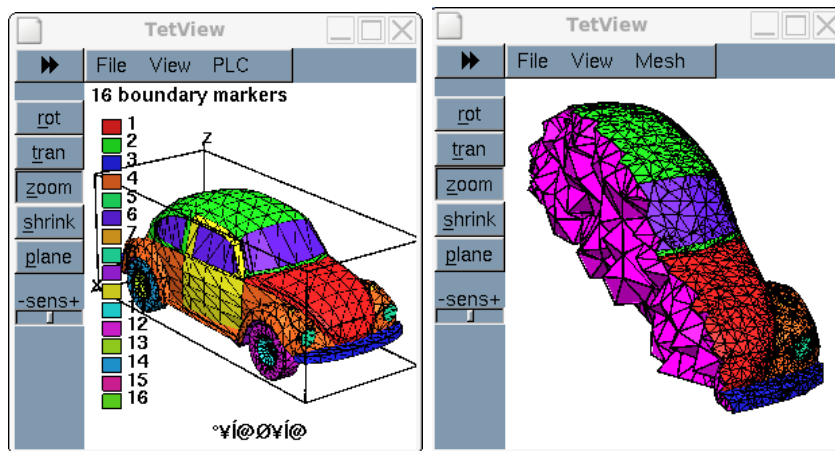

Figure 13: TetView. Left: displays a surface mesh of a car. Right: displays one of the views of the tetrahedral mesh of the car.

2.3.2 Other Mesh Viewers

Two programs can be alternatively used to view the mesh created by TetGen, both are publicly available and run on most computer systems. They are:

- *Medit*, a user-friendly mesh viewer, available at <http://www-rocq.inria.fr/gamma/medit>.
- *Gid*, the personal pre- and post-processor, available at <http://gid.cimne.upc.es>.

For viewing mesh under Medit, add a '-g' switch in the command line. TetGen will additionally output a file `example.1.mesh`, which can be read and rendered directly by Medit. Try running:

```
tetgen -pg example.poly
medit example.1
```

By invoking '-G' switch in command line, two additional files `example.1.ele.msh` and `example.1.face.msh` will be output by TetGen, which are tetrahedral mesh and surface mesh, respectively. These files can be loaded into Gid (version 7.0) using menu "Files" → "Import" → "Gid Mesh...".

3 Using TetGen

This section describes the use of TetGen as a stand alone program. It is invoked from the command line with a set of switches and an input file name. Switches are used to control the behavior of TetGen and to specify the output files. In correspondence to the different switches, TetGen will generate the Delaunay tetrahedrization, or the boundary constrained (Delaunay) tetrahedrization, or the quality conforming (Delaunay) mesh.

3.1 Command Line Syntax

The command line syntax to run TetGen is:

```
tetgen [-pq__a__AriYMS__T__dzjo_fengGOJBNEFICQVvh] input_file
```

Underscores indicate that numbers may optionally follow certain switches. Do not leave any space between a switch and its numeric parameter. These switches are explained in Section 3.2.

“input_file” can be different files depending on the switches you use. If no switch is used, it must be a file with extension `.node` which contains a list of 3D points and the Delaunay tetrahedralization of this point set will be generated.

If the `-p` switch is used, “input_file” must be one of the following extensions: `.poly`, `.smesh`, `.off`, `.stl`, and `.mesh`, which contains a piecewise linear complex (or a surface mesh) and the boundary constrained (Delaunay) tetrahedralization of this object will be generated. If the `-q` switch is used together, the quality conforming tetrahedral mesh will be generated.

If the `-r` switch is used, a pre-created tetrahedral mesh will be read. you must supply `.node` and `.ele` files, and possibly a `.face` file, and a `.vol` file. “input_file” can have no file extension. Together with `-q` switch, the mesh will be refined with respect to the new quality measure and variant constraints.

File formats are described in Section 4.

3.2 Command Line Switches

Table 1 is an overview of all command line switches and a short description follows each switch. This information is also available by invoking TetGen without any switch and input file.

- p Tetrahedralizes a piecewise linear complex (.poly or .smesh file).
- q Quality mesh generation. A minimum radius-edge ratio may be specified (default 2.0).
- a Applies a maximum tetrahedron volume constraint.
- A Assigns attributes to identify tetrahedra in certain regions.
- r Reconstructs and Refines a previously generated mesh.
- Y Suppresses boundary facets/segments splitting.
- i Inserts a list of additional points into mesh.
- M Does not merge coplanar facets.
- T Set a tolerance for coplanar test (default 1e-8).
- d Detect intersections of PLC facets.
- z Numbers all output items starting from zero.
- o2 Generates second-order subparametric elements.
- f Outputs faces (including non-boundary faces) to .face file.
- e Outputs subsegments to .edge file.
- n Outputs tetrahedra neighbors to .neigh file.
- g Outputs mesh to .mesh file for viewing by Medit.
- G Outputs mesh to .msh file for viewing by Gid.
- O Outputs mesh to .off file for viewing by Geomview.
- J No jettison of unused vertices from output .node file.
- B Suppresses output of boundary information.
- N Suppresses output of .node file.
- E Suppresses output of .ele file.
- F Suppresses output of .face file.
- I Suppresses mesh iteration numbers.
- C Checks the consistency of the final mesh.
- Q Quiet: No terminal output except errors.
- V Verbose: Detailed information, more terminal output.
- v Prints the version information.
- h Help: A brief instruction for using TetGen.

Table 1: Overview of TetGen’s command line switches.

3.2.1 -p Tetrahedralizes a PLC

The `-p` switch reads a piecewise linear complex (PLC) stored in file `.poly` or `.smesh` and generate a constrained Delaunay tetrahedralization (CDT) of the PLC.

The CDT may have extra vertices added on the input boundary of the PLC. If you want no vertices be added on the boundary, add `-Y` swicth (see Section 3.2.8).

If the file extension is not specified, TetGen will look for a file which has extension `.poly` or `.smesh` and use whichever one is available. For example, “`tetgen -p xxx`” opens the file named `xxx.poly` (if it doesn’t exist, open the file `xxx.smesh` instead) and possibly also opens the file `xxx.node`; reads in the whole PLC; and generates a CDT resulting in three files: `xxx.1.node`, `xxx.1.ele`, and `xxx.1.face`.

Other polygonal file formats may be used as input file as well. TetGen recognizes the file format by its file extension. The following file formats are supported: `.off`, `.ply`, `.stl`, and `.mesh`.

In combination with the `-q` or `-a` switch, TetGen will generate a quality tetrahedral mesh of the PLC. `-p` is not compatible with `-r`, and should not be used them together.

3.2.2 -q Quality mesh generation

The `-q` switch performs quality mesh generation by Shewchuk’s Delaunay refinement algorithm [27]. It adds vertices to the CDT (used together with `-p`) or a previously generated mesh (used together with `-r`) to ensure that no tetrahedra have radius-edge ratio greater than 2.0. An alternative minimum radius-edge ratio may be specified after the ‘`q`’. For a too small ratio, e.g., smaller than 1.0, TetGen may not terminate.

If no input angle or input dihedral angle (of the PLC) is smaller than 60° , this algorithm is guaranteed to terminate and no tetrahedron has radius-edge ratio greater than 2.0. In practice, one can observe successful termination for radius-edge ratios down to $\sqrt{2} \approx 1.414$ or even smaller.

Here are some examples of using the `-q` switch. Tests can be executed and compared with the included example file (example.poly):

```
tetgen -pq example
tetgen -rq1.414 example.1
tetgen -ra0.5 example.2
```

3.2.3 -a Imposes volume constraints

The `-a` switch imposes a maximum volume constraint on all tetrahedra. If a number follows the `'a'`, no tetrahedra is generated whose volume is larger than that number.

If no number is specified and the `-r` switch is not used, TetGen will read the region part in file `.poly` or `.smesh`. A `.poly` file or `.smesh` file can optionally contain a volume constraint for each facet-bounded region, thereby controlling tetrahedra densities in a tetrahedralization of a PLC in a more specific way.

One can impose both a fixed volume constraint and a varying volume constraint for some regions by invoking the `-a` switch twice, once with and once without a number following. Each volume specified may include a decimal point.

If no number is specified and the `-r` switch is used, a `.vol` file is expected, which contains a separate volume constraint for each tetrahedron. It is useful for refining a finite element or finite volume mesh based on a posteriori error estimates.

3.2.4 -A Assigns region attributes

The `-A` switch assigns an additional attribute (an integer number) to each tetrahedron that identifies what facet-bounded region each tetrahedron belongs to.

Attributes are assigned to regions by the `.poly` or `.smesh` file (in the region section). If a region is not explicitly marked by the `.poly` file or `.smesh` file, tetrahedra in that region are automatically assigned a zero attribute.

If you want TetGen to automatically assign each tetrahedron a region attribute even the region has no attribute assigned in `.poly` or `.smesh` file. You can apply `'-A'` switch twice (e.g., `'-AA'`). In your output mesh, all tetrahedra in the same region will get a non-zero attribute. Default, attributes are numbered from 1, 2, 3, and so on. If an attribute has already been used (assigned in `.poly` or `.smesh`), it is skipped and the next available attribute will be used.

The `-A` switch has an effect only when the `-p` switch is used and the `-r` switch is not.

3.2.5 -r Reconstructs/refines a mesh

The `-r` switch reconstructs a previously generated mesh. The mesh is read from a `.node` and an `.ele` file, and possibly a `.face` file. If a `.face` file exists, it is read and used to constrain subfaces in the mesh, else, TetGen will

automatically identify the subfaces, internal subfaces are also identified by comparing the attributes of two adjacent tetrahedra. Subsegments will be automatically identified from the existing subfaces. The reconstructed mesh is distinguished from its origin with a different iteration number.

For example, “tetgen -r xxx.1” reads the mesh in files xxx.1.node, xxx.1.ele and possibly xxx.1.face and xxx.1.edge if they exist; reconstructs the mesh; outputs it into three files xxx.2.node, xxx.2.ele and xxx.2.face. Now, xxx.2 can be used as input in the above command, the result is another mesh saved files xxx.3.node, and so on. Mesh iteration numbers allow you to create a sequence of successively finer meshes.

One can refine a mesh by combining -r with the -q, -a, and -i switches. Several ways are possible:

- One can impose tighter quality constraints by using the -q with a smaller number, or the -a followed by a smaller volume than the one used to generate the mesh currently refining.
- One can create a .vol file, which specifies a maximum volume for each tetrahedra, and use the -a switch (without a number following). Each tetrahedron’s volume constraint is applied to that tetrahedra.
- One can create a .node file, which contains a list of additional nodes to insert in the mesh. Use the -i switch to inform TetGen that an additional node list needs to be inserted.

-r should not be used with the -p and -I together.

3.2.6 -i Inserts additional points

The -i switch indicates to insert a list of additional points into a CDT (when -p switch is used) or a previously generated mesh (when -r switch is used). The list of additional file is read from file xxx-a.node, which xxx stands for the input file name (i.e., xxx.poly or xxx.smesh, or xxx.ele, ...). This switch is useful for refining a finite element or finite volume mesh using a list of user-defined points. Following are some pointers that you may need be careful:

- Points lie out of the mesh domain are ignored by TetGen.
- The mesh may not be constrained Delaunay or conforming Delaunay any more after the insertion of additional points. However, in combination with the -q switch, TetGen will automatically add additional points to ensure the conforming Delaunay property of the mesh.

3.2.7 -T Sets a tolerance

The -T switch sets a user-defined tolerance used by many computations of TetGen, default is $1e - 8$.

In principle, the vertices which are used to define a facet of a PLC should be exactly coplanar. But this is very hard to achieve in practice due to the inconsistent nature of the floating-point format used in computers.

TetGen accepts facets which vertices are not exactly but approximately coplanar. Four points a , b , c and d are coplanar as long as the ratio v/l^3 is smaller than the given tolerance, where v and l are the volume and the average edge length of the tetrahedron $abcd$, respectively.

To choose a proper tolerance according to the input point set will usually reduce the number of adding points and improve the mesh quality.

3.2.8 -Y Prohibit Steiner Points on Boundary

The -Y switch suppresses the creation of Steiner points on the exterior boundary. Interior Steiner points may still be created.

This switch is useful when the mesh boundary must be preserved so that it conforms to some adjacent mesh.

Specify this switch twice ('-YY') to prevent all boundary splitting, including interior boundaries.

You can use -Y together with -q switch (to improve the quality of the mesh), TetGen will try, but the resulting mesh may contain tetrahedra of poor quality. However, it works well if all the boundaries are previously subdivided into well shaped and closely spaced patches.

3.2.9 Other Switches

-I The -I switch does not use the iteration numbers, it suppresses the output of .node file, so your input file won't be overwritten. It cannot be used with the -r switch, because that would overwrite your input .ele file. It shouldn't be used with the -q, -a, -s, or -t switch if one is using a .node file for input, because no .node file is written, so there is no record of any added Steiner points.

-z The -z switch numbers all output items starting from zero. This switch is useful in case of calling TetGen from another program.

-o2 TetGen generates meshes with quadratic elements if the -o2 switch is specified. Quadratic elements have ten nodes per element, rather than four.

The six extra nodes of a tetrahedron fall at the midpoints of its six edges. Refer to Section 4.1.4 (.ele file format) to find out how the extra nodes are locally related to a tetrahedron.

-C The `-C` switch indicates TetGen to check the consistency of the mesh on finish. If it is specified twice, i.e., `'-CC'`, TetGen also checks constrained Delaunay (for the `-p` switch) or conforming Delaunay (for `-q`, `-a`, or `-i`) property of the mesh.

-V The `-V` switch gives detailed information about what TetGen is doing. More `'V'`s are increasing the amount of detail.

Specifically, `'-V'` gives information on algorithmic progress and more detailed statistics including a rough mesh quality report. To get the statistics for an existing mesh, run TetGen on that mesh with the `'-rNEP'` switches to read the mesh and print the statistics without writing any files.

`'-VV'` gives more details on the algorithms, and slow down the execution. While `'-VVV'` is only useful for debugging.

3.3 Command Line Examples

TetGen generates Delaunay, constrained tetrahedralizations, and quality meshes according to different command line switches and input files. This section provides several examples of each task.

3.3.1 Generate Delaunay tetrahedralizations

For a set of 3D points, TetGen computes its exact Delaunay tetrahedralization (DT). After getting the DT, the convex hull of the point set is obtained by taking the outmost faces of the DT, which is a list of triangular faces.

Figure 14 (a) shows a set V of 3D points. Store V in a `.node` file, such as `r100.node`. The command

```
tetgen r100.node
```

produces the DT of V shown in Figure 14 (b). The convex hull of V is highlighted in Figure 14 (c).

3.3.2 Generate Constrained Delaunay tetrahedralizations

For a piecewise linear complex (see 1.2.1), TetGen generates its constrained Delaunay tetrahedralization (CDT), and quality tetrahedral mesh. The latter

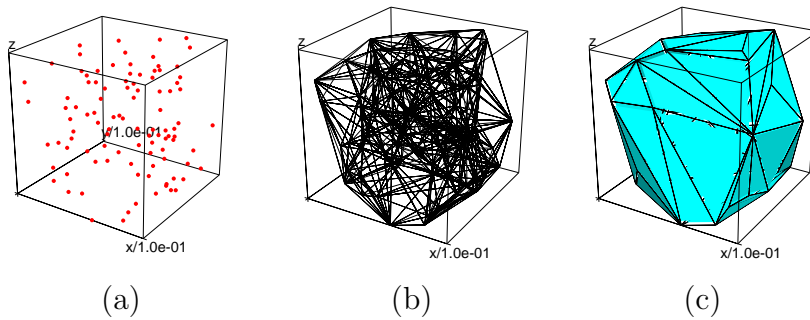

Figure 14: Generate Delaunay tetrahedralizations. (a) A set V of 3D points. (b) The DT of V . (c) The convex hull of V .

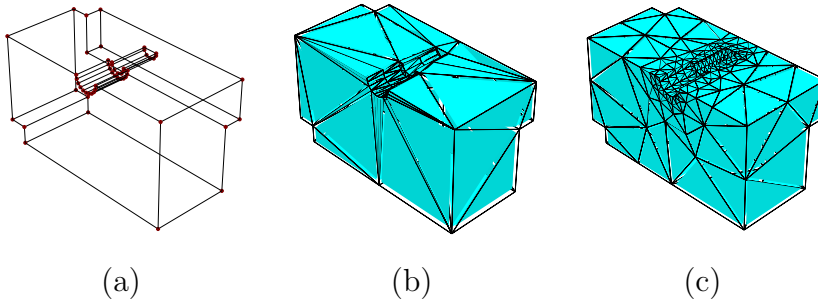

Figure 15: Generate constrained Delaunay tetrahedralizations. (a) A PLC X . (b) The CDT of X . (c) The quality conforming Delaunay mesh of X .

is also a conforming Delaunay tetrahedralization if the PLC contains no small input angle (i.e., angle less than 90 degree).

To do so, save the PLC in a `.poly` or `.smesh` file, such as `example.poly`. Use `-p` switch to tell TetGen the input file is a PLC. Pictures in Figure 15 illustrate a PLC, its CDT and its quality conforming Delaunay mesh by the following commands, respectively.

```
tetgen -p example
tetgen -pq example
```

3.3.3 Mesh Quality, Mesh Size Control

TetGen allows you to specify a quality bound (`-q` switch with a small number, default is 2.0), or to impose a maximum volume bound on all tetrahedra (`-a`

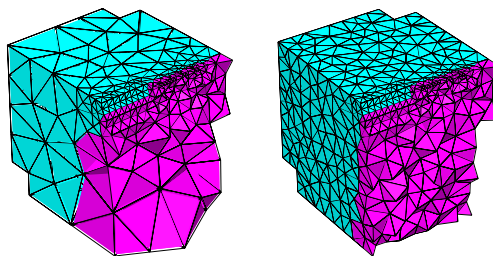

Figure 16: Mesh quality, mesh size control. Left: A higher mesh quality bound is imposed. Right: A maximum volume bound is imposed.

switch with a small volume) to improve the mesh quality. The resulting mesh will have different quality and size corresponding the command line switches you imposed. The pictures in Figure 16 shows the effects on the example in the previous section with the following commands, respectively.

```
tetgen -pq1.3 example  
tetgen -pq1.3a1.0 example
```

Besides imposing a maximum volume bound on all tetrahedra, you can impose a maximum area bound on a facet, or a maximum edge length on a segment of the input PLC. To do so, you specify the facet or segment with the corresponding area or length constraint in a `.var 4.1.9` file. Supply this file along with the PLC file (i.e. `.poly` or `.smesh`) and use `-p`, `-q` switches to invoke TetGen. The `.var` file format allows you to specify as many as facets or segments.

.node	input/output	a list of nodes.
.poly	input	a PLC.
.smesh	input/output	a simple PLC.
.ele	input/output	a list of tetrahedra.
.face	input/output	a list of triangular faces.
.edge	output	a list of boundary edges.
.vol	input	a list of maximum volumes.
.var	input	a list of variant constraints.
.neigh	output	a list of neighbors.

Table 2: Overview of TetGen’s file formats.

4 File Formats

4.1 TetGen File Formats

Table 2 lists each file formats. All files are of ASCII form and may contain comments prefixed by the character ‘#’. Points, tetrahedra, facets, holes, and maximum volume constraints must be numbered consecutively, starting from either 1 or 0. However, all input files must be consistent. TetGen automatically detects your choice while reading the .node (or .poly or .smesh) file. When calling TetGen from another program, use the -z switch if you wish to number objects from zero.

Remark: in the following description ‘#’ stands for ‘number’ – it should not cause confusion with the comment prefix.

4.1.1 .node files

First line: <# of points> <dimension (3)> <# of attributes>
 <boundary markers (0 or 1)>

Remaining lines list # of points:

<point #> <x> <y> <z> [attributes] [boundary marker]

...

A .node file contains a list of three-dimensional points. Each point has three coordinates (x, y and z), probably has one or several attributes, and a boundary marker as well. The .node files used as both input and output files to represent the point set of a PLC, or the point set of a mesh, or a set of additional points (for the -i switch) which need to be inserted into a mesh. The example below demonstrates the layout of the .node file.

```

# Node count, 3 dim, no attribute, no boundary marker
8 3 0 0
# Node index, node coordinates
1 0.0 0.0 0.0
2 1.0 0.0 0.0
3 1.0 1.0 0.0
4 0.0 1.0 0.0
5 0.0 0.0 1.0
6 1.0 0.0 1.0
7 1.0 1.0 1.0
8 0.0 1.0 1.0

```

The attributes, which are typically floating-point values of physical quantities (such as mass or conductivity) associated with the points, are copied unchanged to the output mesh. If `-p` switch is used, each new Steiner point inserted on segments of the mesh has attributes assigned to it by linear interpolation. Furthermore, if `-q`, `-a`, or `-i` is selected, each new point added to the mesh to improve mesh quality has attributes zero.

If the fourth entry of the first line is '1', the last column of the remainder of the file is assumed to contain boundary markers. Boundary markers are used to identify boundary points (points resting on PLC facets). The `.node` file produced by TetGen contains boundary markers in the last column unless they are suppressed by the `-B` switch. The boundary marker associated with each point in an output `.node` file is chosen as follows:

- If a point is assigned a nonzero boundary marker in the input file, then it is assigned the same marker in the output `.node` file.
- Otherwise, if the node lies on a PLC facet with a nonzero boundary marker, then the node is assigned the same marker that facet has. If the node lies on several such facets, one of the markers is chosen arbitrarily.
- Otherwise, if the node occurs on a boundary of the mesh, then the node is assigned the marker (1).
- Otherwise, the point is assigned the marker zero (0).

TetGen can determine which points are on the boundary, input with the boundary marker zero (or use no markers at all) will result in output with boundary marker (1) for all points on the boundary.

4.1.2 `.poly` files

A `.poly` file represents a piecewise linear complex (PLC) as well as some additional information. Although there is no restriction on facets of PLCs,

TetGen requires that the mesh region represented by a PLC should be completely facet-bounded, i.e. it is waterproof.

The .poly file format consists of four parts, which are a list of points, a list of facets, a list of (volume) hole points, and a list of region attributes, respectively. The first three parts are mandatory, but the fourth part is optional.

The four parts are described below. In the end of this section, a .poly file which describes a $1 \times 1 \times 1$ cube is provided.

Part 1 - node list

```
First line: <# of points> <dimension (3)> <# of attributes>
            <boundary markers (0 or 1)>
Remaining lines list # of points:
    <point #> <x> <y> <z> [attributes] [boundary marker]
    ...
```

Part 1 lists all the points, and is identical to the format of .node files. <# of points> may be set to zero to indicate that the points are listed in a separate .node file.

Part 2 - facet list

```
One line: <# of facets> <boundary markers (0 or 1)>
Following lines list # of facets:
    <facet #>
    ...
```

Each facet is indeed a planar straight line graph (PSLG), it is a polygonal region which may contain segments, single points and holes. A list of *polygons* consist of a facet. Each polygon has n corners, $n \geq 1$. It can be degenerate, i.e., $n = 1$ or $n = 2$ represents a single point or a segment, respectively. The format of a facet is:

```
One line: <# of polygons> [# of holes] [boundary marker]
Following lines list # of polygons:
    <# of corners> <corner 1> <corner 2> ... <corner #>
    ...
Following lines list # of holes:
    <hole #> <x> <y> <z>
    ...
```

Each polygon is specified by giving the number of corners, followed by the list of ordered indices of those corners. It doesn't matter which order (counterclockwise or clockwise) you choose to list the indices. Each line of indices should not be arbitrarily long because the maximum characters per line read by TetGen is 1024. The list can be broken into several lines.

A hole in a facet (don't confuse with the volume hole below) is specified by identifying a point inside the hole. The list of hole points (consecutively) follows the list of polygons.

If the boundary markers is '1', TetGen will produce an additional boundary marker for each face in .face file (in the last column of each record). You can prevent boundary markers from being written into .face file by using the -B switch.

Boundary markers of facets are tags used mainly to identify which faces of the tetrahedralization are associated with which PLC facet, hence identify which faces occur on a boundary of the tetrahedralization. A common use is to determine where different boundary condition types should be applied to a mesh.

Part 3 - (volume) hole list

```
One line: <# of holes>
Following lines list # of holes:
  <hole #> <x> <y> <z>
  ...
```

Holes in the volume are specified by identifying a point inside each hole. After the constrained Delaunay tetrahedrization is formed, TetGen creates holes by removing tetrahedra. Thus exactly is the reason why TetGen requires a closed boundary of the PLCs. In case of non-closed PLC facets the whole tetrahedrization will be 'eaten' away. If two tetrahedra abutting a subface are removed, the subface itself is also vanished. Hole points have to be placed inside a region, else the rounding error determines which side of the facet is being transformed into the hole.

Part 4 - region attributes list

```
One line: <# of region>
Following lines list # of region attributes:
  <region #> <x> <y> <z> <region number> <region attribute>
  ...
```

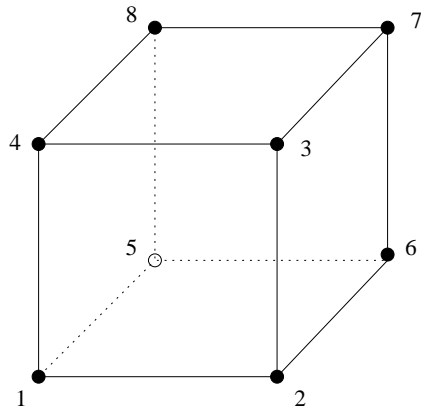

Figure 17: A $1 \times 1 \times 1$ cube.

The optional fourth section lists regional attributes (to be assigned to all tetrahedra in a region) and regional constraints on the maximum tetrahedron volume. TetGen will read this section only if the `-A` switch is used or the `-a` switch without a number is invoked. Regional attributes and volume constraints are propagated in the same manner as holes.

If two values are written on a line after the x , y and z coordinate, the former is assumed to be a regional attribute (but will only be applied if the `-A` switch is selected), and the latter is assumed to be a regional volume constraint (but will only be applied if the `-a` switch is selected). It is possible to specify just one value after the coordinates. It can serve as both an attribute and an volume constraint, depending on the choice of switches. A negative maximum volume constraint allows to use the `-A` and the `-a` switches without imposing a volume constraint in this specific region.

In the following, a $1 \times 1 \times 1$ cube (see Figure 17) is described by the poly file format.

```
# Part 1 - node list
# node count, 3 dim, no attribute, no boundary marker
8 3 0 0
# Node index, node coordinates
1 0.0 0.0 0.0
2 1.0 0.0 0.0
3 1.0 1.0 0.0
4 0.0 1.0 0.0
5 0.0 0.0 1.0
6 1.0 0.0 1.0
7 1.0 1.0 1.0
8 0.0 1.0 1.0
```

```

# Part 2 - facet list
# facet count, no boundary marker
6 0
# facets
1          # 1 polygon, no hole, no boundary marker
4 1 2 3 4  # front
1
4 5 6 7 8  # back
1
4 1 2 6 5  # bottom
1
4 2 3 7 6  # right
1
4 3 4 8 7  # top
1
4 4 1 5 8  # left

# Part 3 - hole list
0          # no hole

# Part 4 - region list
0          # no region

```

4.1.3 .smesh files

A .smesh file represents a PLC of special type - surface meshes. The .smesh file format is a simplified version of the .poly format, that each facet only has exactly one polygon, no holes, no segment and point inside. It is less flexible than the .poly file format but is much simpler and useful when the surface mesh is created by other programs.

The same as .poly file format, the .smesh file format consists of four parts, which are points, facets, holes and regions, respectively. Only the part describing facets is different from the .poly format. It is described below.

Part 2 - facet list

```

One line: <# of facets> <boundary markers (0 or 1)>
Following lines list # of facets:
  <# of corners> <corner 1> ... <corner #> [boundary marker]
  ...

```

Each facet consists of exactly one polygon. The corner list of each polygon can be distributed over a number of lines. The optional boundary marker of each facet is given at the end of the corner list.

The following example demonstrates the layout of facet part of the unit cubde (Figure 17).

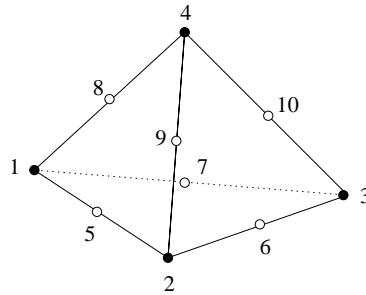

Figure 18: The numbering of nodes of a 10-node tetrahedron.

```
# Part 2 - facet list
# facet count, no boundary marker
6 0
# facets
4 1 2 3 4 # front
4 5 6 7 8 # back
4 1 2 6 5 # bottom
4 2 3 7 6 # right
4 3 4 8 7 # top
4 4 1 5 8 # left
```

4.1.4 .ele files

```
First line: <# of tetrahedra> <nodes per tet. (4 or 10)>
            <region attribute (0 or 1)>
Remaining lines list # of tetrahedra:
  <tetrahedron #> <node> <node> ... <node> [attribute]
  ...
```

An .ele file contains a list of tetrahedra. Each tetrahedron has four corners (or ten corners if -o2 switch is used). Nodes are indices into the corresponding .node file. The first four nodes are the corner vertices. If -o2 is used, the remaining six nodes are generated on the midpoints of the edges of the tetrahedron. Figure 18 shows how these nodes are locally numbered.

If the region attribute in the first line is '1', each tetrahedra has an additional region attribute (an integer) in the last column. Region attributes of tetrahedra are tags used mainly to identify which tetrahedra of the tetrahedralization are associated with which facet-bounded region of the PLC, set in the part 4 of a .poly or a .smesh file. Region attributes do not diffuse across facets, all tetrahedra in the same region have exactly the same region attribute. A common use of the region attribute is to determine which

material a tetrahedron has.

The `.ele` file is the default output file of TetGen if it generated a mesh or tetrahedralization. However, it can be omitted by `-E` switch. If `-r` switch is used, TetGen reads a `.ele` file and reconstructs a tetrahedral mesh from it.

The following example illustrates the layout of the `.ele` file.

```
154 4 0
  1 4 107 3 50
  2 4 108 3 107
  3 9 97 95 94
  4 4 107 50 93
  5 56 1 50 47
  6 94 98 97 95
  7 97 9 95 55
  8 52 55 5 51
  ...
```

4.1.5 `.face` files

First line: `<# of faces> <boundary marker (0 or 1)>`

Remaining lines list # of faces:

`<face #> <node> <node> <node> [boundary marker]`

...

A `.face` file contains a list of triangular faces, which may be boundary faces (if `-p` or `-r` switch is used), or convex hull faces. Each face has three corners and possibly has a boundary marker. Nodes are indices into the corresponding `.node` file.

After generating a mesh or Delaunay tetrahedralization, TetGen default outputs the boundary faces or the convex hull into a `.face` file. However, this file can be omitted by `-F` switch. If `-r` switch is used, TetGen can also read the `.face` file for identifying boundary faces in a reconstructed mesh. The optional column of Boundary markers is suppressed by the `-B` switch.

If the boundary marker in the first line is '1', each face has an additional boundary marker (an integer) in the last column. Boundary markers of facets are defined in the `.poly` or the `.smesh` files. They are tags used mainly to identify which faces of the tetrahedralization are associated with which PLC facet, and to identify which faces occur on a boundary of the tetrahedralization. A common use is to determine where different boundary conditions.

4.1.6 `.edge` files

First line: `<# of edges>`

```
Remaining lines list # of edges:
  <edge #> <endpoint> <endpoint>
  ...
```

A .edge file contains a list of edges, which are (sub)segments of a PLC. Each edge has two endpoints which are indices into the corresponding .node file. It is part of TetGen's output when -e switch is used.

4.1.7 .vol files

```
First line: <# of tetrahedra>
Remaining lines list # of maximum volumes:
  <tetrahedron #> <maximum volume>
  ...
```

A .vol file associates with each tetrahedron a maximum volume which is used for mesh refinement. It is read by TetGen in case the -r switch is used.

As with other file formats, every tetrahedron must be represented, and they must be numbered consecutively. A tetrahedron may be left unconstrained by assigning it a negative maximum volume.

4.1.8 .var files

```
One line: <# of facet constraints>
Remaining lines list # of facet constraints:
  <constraint #> <boundary marker> <maximum area>
  ...
One line: <# of segment constraints>
Remaining lines list # of segment constraints:
  <constraint #> <point1> <point2> <maximum length>
  ...
```

A .var file allows you to specify variant constraints on facets and segments. Like the maximum volume bound set to a region, each facet can have a maximum area bound. On the output, no subface of the facet has area larger than that bound. Likewise, each segment can have a maximum length bound, hence, the subsegments of that segment will no longer than it.

Facet constraint is set on facet by specifying the boundary marker which is the integer assigned that facet in the corresponding .poly or .smesh file. Segment constraint is set to a segment by specifying two indices of endpoints of the segment.

The following example illustrates the layout of a .var file. It can be used together with the included file "example.poly".

.off	input/output	Geomview's polyhedral file format.
.ply	input	Polyhedral file format.
.stl	input	Stereolithography format.
.mesh	input/output	Medit's surface mesh file format.

Table 3: Overview of supported file formats.

```

# Facet constraints
1          # 1 constraint
1 2 0.5    # Set maximum area constraint (0.5) on all facets
           #   having boundary marker 2.

# Segment constraints
10         # 10 constraints
1 32 33 0.05 # Set maximum edge length constraint (0.05) on
            #   segment with endpoints 32 and 33.
2 33 34 0.05
3 34 35 0.05
4 35 36 0.05
5 36 37 0.05
6 37 38 0.05
7 38 39 0.05
8 39 40 0.05
9 40 41 0.05
10 41 42 0.05

```

4.1.9 .neigh files

```

First line: <# of tetrahedra> <# of nei. per tet. (always 4)>
Following lines list # of neighbors:
  <tetrahedra #> <neighbor> <neighbor> <neighbor> <neighbor>
  ...

```

A .neigh file associates with each tetrahedron its neighbors (adjacent tetrahedra), which are indices into the corresponding .ele file. An index of -1 indicates no neighbor (because the tetrahedron is on a boundary of mesh domain). The first neighbor of tetrahedron i is opposite the first corner of tetrahedron i , and so on. It is output by TetGen when `-n` switch is used.

4.2 Supported File Formats

TetGen supports some polyhedral file formats as well. Table 3 lists the supported file formats. TetGen recognizes the file formats by the file extensions.

4.2.1 .off files

.off is the one of the file formats of Geomview <http://www.geomview.org> - an interactive 3D viewing program for Unix/Linux. It represents collections of planar polygons with possibly shared vertices, a convenient way to describe polyhedra. The polygons may be concave but there's no provision for polygons containing holes.

The description of .off file format can be found elsewhere in the internet. Below is a simple description of this file format.

```
OFF numVertices numFaces numEdges
  x y z
  x y z
  ... numVertices like above
NVertices v1 v2 v3 ... vN
MVertices v1 v2 v3 ... vM
  ... numFaces like above
```

Note that vertices are numbered starting at 0 (not starting at 1), and that numEdges will always be zero.

4.2.2 .ply files

The .ply file format is a simple object description that was designed as a convenient format for researchers who work with polygonal models. Early versions of this file format were used at Stanford University and at UNC Chapel Hill.

A description as well as examples, codes of the PLY file format can be found at <http://astronomy.swin.edu.au/~pbourke/geomformats/ply>.

4.2.3 .stl files

The .stl or stereolithography format is an ASCII or binary file used in manufacturing. It is a list of the triangular surfaces that describe a computer generated solid model. This is the standard input for most rapid prototyping machines.

The description of .stl file format can be found elsewhere on the web. An elaborated description can be found at <http://www.sdsc.edu/tmf/Stl-specs/stl.html>. Below is an example.

```
solid
  ...
```

```

facet normal 0.00 0.00 1.00
  outer loop
    vertex 2.00 2.00 0.00
    vertex -1.00 1.00 0.00
    vertex 0.00 -1.00 0.00
  endloop
endfacet
...
endsolid

```

4.2.4 .mesh files

.mesh is the file formats of Medit - an interactive 3D mesh viewing program <http://www.ann.jussieu.fr/~frey/logiciels/medit.html>. This file format is described in the documentation of Medit.

A repository of free 3D models in this file format are available at INRIA's Free 3D Meshes Download <http://www-rocq1.inria.fr/gamma>.

4.3 File Format Examples

This section provides two examples. They are designed to support interactive learning. The topics are description of the PLCs using TetGen's .poly file format and constructing different quality meshes through the command line switches.

4.3.1 A PLC with Two Boundary Markers

Figure 19 shows the geometry of a rectangular bar. This bar consists of eight nodes and six facets (which are all rectangles). In addition, there are two boundary markers (-1 and -2) associated to the leftmost facet and the rightmost facet, respectively. This simple model has its physical meaning. It can be seen as a typical heat transfer problem. The task is to compute the temperature diffusion in the bar, in which the flow of heat moves from hot side to cold side. The two boundary markers can represent two different boundary conditions, one has high temperature and the other has low temperature. Here is the input file "bar.poly" describing the bar:

```

# Part 1 - the node list.
# A bar with 8 nodes in 3D, no attributes, no boundary marker.
8 3 0 0
# The 4 leftmost nodes:

```

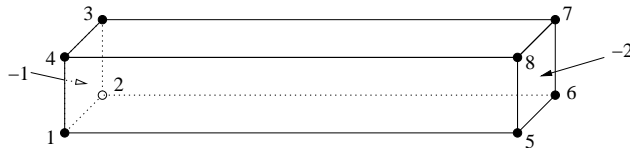

Figure 19: A bar having two boundary markers (-1 and -2) defined.

```

1 0 0 0
2 2 0 0
3 2 2 0
4 0 2 0
# The 4 rightmost nodes:
5 0 0 12
6 2 0 12
7 2 2 12
8 0 2 12
# Part 2 - the facet list.
# Six facets with boundary markers.
6 1
# The leftmost facet.
1 0 -1 # 1 polygon, no hole, boundary marker (-1)
4 1 2 3 4
# The rightmost facet.
1 0 -2 # 1 polygon, no hole, boundary marker (-2)
4 5 6 7 8
# Other facets.
1
4 1 5 6 2 # bottom side
1
4 2 6 7 3 # back side
1
4 3 7 8 4 # top side
1
4 4 8 5 1 # front side
# Part 3 - the hole list.
# There is no hole in bar.
0
# Part 4 - the region list.
# There is no region defined.
0

```

The command line is chosen as follows: first mesh the PLC (-p), then impose the quality constraint (-q). This will result a quality mesh in three files: bar.1.node, bar.1.ele, and bar.1.face.

```
> tetgen -pq bar
```

Here is the output file “bar.1.node”. It contains 47 points. The additional points were added by TetGen automatically to meet the quality measure.

```

47 3 0 0
  1  0 0 0
  2  2 0 0
  3  2 2 0
  4  0 2 0
  5  0 0 12
  6  2 0 12
  7  2 2 12
  8  0 2 12
  9  1.0000469999999999 0 0
 10  0 0.999668 0
 11  0 0.99944500000000003 12
 12  1.000594 0 12
...
# Generated by tetgen -pq bar

```

Here is the output file “bar.1.ele”, which contains 83 tetrahedra.

```

83 4 0
  1  18  33  20  34
  2   9   2   3  25
  3  17  18  20  34
  4  43  32  18  37
  5  19  20  30  33
  6  14  41  13  42
  7  12  26   7   6
  8  10  28   1   9
  9  28  33  18  34
 10  35  41  38  45
 11  10   9  25  28
 12   3  25  19  30
...
# Generated by tetgen -pq bar

```

Here is the output file “bar.1.face” with 90 boundary faces. Faces 1 and 2 are on the leftmost facet thus have markers -1 ; faces 3 and 4 have markers -2 indicating they are on the rightmost facet. Other faces have the default markers zero.

```

90 1
  1   3   4  10  -1
  2  10   9   3  -1
  3   7  12  11  -2
  4   7  11   8  -2
  5  18  37  43   0

```

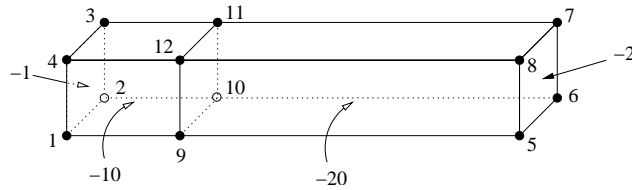

Figure 20: A bar having two regions (with region attributes -10 and -20 , respectively) and two boundary markers (-1 and -2) defined.

```

6      24      46      39      0
7      26       6       7       0
8      35      22      24       0
9      29       7       8       0
10     39       7      29       0
11     29      11      27       0
12     23      45      38       0
...
# Generated by tetgen -pq bar

```

However, the mesh above may be too coarse for numerical simulation using finite element method or finite volume method. Using either $-q$ or $-a$ switch or both of them will result a more dense quality mesh:

```
> tetgen -pq1.414a0.1 bar
```

TetGen generates a mesh with 330 points and 1092 tetrahedra. The added points are due to both the $-q$ and $-a$ switches we've applied. To see a quality report of the mesh, type:

```
> tetgen -rNEFV bar.1
```

4.3.2 A PLC with Two Regions

In this example, we add an internal boundary facet into the bar (in Figure 19), so that create two regions (separated by the newly added facet) in the bar. Figure 20 shows the modified geometry. This bar consists of twelve nodes (which I numbered) and seven facets (Note, some of them are not a single polygon any more). In addition, there are two regions defined, which have region attributes -10 and -20 , respectively. Physically, you can associate two different materials to each of these two regions. And the two boundary markers (-1 and -2) in last example still remain. Here is the input file "bar2.poly" describing the modified bar:

```

# Part 1 - the node list.
# The model has 12 nodes in 3D, no attributes, no boundary marker.
12 3 0 0
# The 4 leftmost nodes:
1 0 0 0
2 2 0 0
3 2 2 0
4 0 2 0
# The 4 rightmost nodes:
5 0 0 12
6 2 0 12
7 2 2 12
8 0 2 12
# The 4 added nodes:
9 0 0 3
10 2 0 3
11 2 2 3
12 0 2 3
# Part 2 - the facet list.
# Seven facets with boundary markers.
7 1
# The leftmost facet.
1 0 -1 # 1 polygon, no hole, boundary marker (-1)
4 1 2 3 4
# The rightmost facet.
1 0 -2 # 1 polygon, no hole, boundary marker (-2)
4 5 6 7 8
# Each of following facets has two polygons, which are
# one rectangle (6 corners) and one segment.
2
6 1 9 5 6 10 2 # bottom side
2 9 10
2
6 2 10 6 7 11 3 # back side
2 10 11
2
6 3 11 7 8 12 4 # top side
2 11 12
2
6 4 12 8 5 9 1 # front side
2 12 9
# The internal facet separates two regions.
1
4 9 10 11 12
# Part 3 - the hole list.
# There is no hole in bar.
0
# Part 4 - the region list.
# There are two regions (-10 and -20) defined.

```

```

2
1 1.0 1.0 1.5 -10 0.1
2 1.0 1.0 5.0 -20 -1

```

The command line “tetgen -pqaA bar2” generates the file “bar2.1.ele”. The first eight lines are listed next. It differs from “bar.1.ele” in that each record has an additional region attribute.

```

431 4 1
1 32 57 50 60 -20
2 51 23 50 49 -20
3 88 138 116 149 -10
4 76 96 95 36 -20
5 29 55 56 52 -20
6 132 138 88 139 -10
7 65 138 132 139 -10
8 16 54 53 15 -20
...
# Generated by tetgen -pqaA bar2

```

Visualization of the resulting meshes (by TetView or other tools) shows the refinement in the region with attribute -10 is denser than the other. This is due to the volume constraints (0.1) defined in the file “bar2.poly” and the ‘-aA’ switches.

5 Calling TetGen from Another Program

In addition to being used as a stand alone program, TetGen can be called from another program. The TetGen library provides functions and data structures. One of the advantages of using the TetGen library is that it can be repeatedly called by other programs without the overhead of reading and writing files. The feature is very useful for applications like adaptive FEM and FVM methods.

This section gives the necessary instructions for using the TetGen library. Examples are included for better understanding. Users are supposed to be able to use TetGen, i.e., know its command line switches and the input and output file formats. Furthermore, Section 2 contains the instruction of how to compile TetGen into a library.

5.1 The Header File

All programs calling TetGen must include the header file “tetgen.h”.

```
#include "tetgen.h"
```

It includes all data types and function declarations of the TetGen library. More specifically, it defines the function “tetrahedralize()” and the data type “tetgenio”, which are provided for users to call TetGen with all its functionalities. They are described in Section 5.2 and Section 5.3, respectively.

5.2 The Calling Convention

The function “tetrahedralize()” is declared as follows:

```
void tetrahedralize(char *switches, tetgenio *in, tetgenio *out)
```

The parameter “switches” is a string containing the command line switches for this call. In this string, no initial dash ‘-’ is required. The ‘Q’ (quiet) switch is recommended in the final code. The ‘I’ (no iteration numbers), ‘g’ (.mesh file output), and ‘G’ (.msh file output) switches have no effect.

The parameters “in” and “out”, which are two pointers pointing to objects of “tetgenio”, describing the input and the output. “in” and “out” may never be NULL.

5.3 The “tetgenio” Data Type

The “tetgenio” structure is used to pass data into and out of the tetrahedralize() procedure. It replaces the input and output files of TetGen by a collection of arrays, which are used to store points, tetrahedra, markers, and so forth. It is declared as a C++ class including data fields and functions. The data fields of “tetgenio”:

```
int firstnumber; // 0 or 1, default 0.
int mesh_dim;   // must be 3.

REAL *pointlist;
REAL *pointattributelist;
REAL *addpointlist;
int *pointmarkerlist;
int numberofpoints;
int numberofpointattributes;
int numberofaddpoints;

int *tetrahedronlist;
REAL *tetrahedronattributelist;
REAL *tetrahedronvolumelist;
int *neighborlist;
int numberoftetrahedra;
int numberofcorners;
int numberoftetrahedronattributes;

facet *facetlist;
int *facetmarkerlist;
int numberoffacets;

REAL *holelist;
int numberofholes;

REAL *regionlist;
int numberofregions;

REAL *facetconstraintlist;
int numberoffacetconstraints;

REAL *segmentconstraintlist;
int numberofsegmentconstraints;

int *trifacelist;
int *trifacemarkerlist;
int numberoftrifaces;

int *edgelist;
int *edgemarkerlist;
```

```
int numberofedges;
```

5.4 Description of Arrays

In all cases, the first item in any array is stored starting at index [0]. However, that item is item number “firstnumber” (0 or 1) unless the ‘z’ switch is used, in which case it is item number ‘0’. Following is the description of arrays.

pointlist An array of point coordinates. The first point’s x coordinate is at index [0], its y coordinate at index [1], and its z coordinate at index [2], followed by the coordinates of the remaining points. Each point occupies three REALs.

pointattributelist An array of point attributes. Each point’s attributes occupy “numberofpointattributes” REALs.

pointmarkerlist An array of point markers; one int per point.

addpointlist An array of additional point coordinates, which will be read and inserted into the mesh when the -i switch is used.. The same structure as “pointlist”, each point occupies three REALs.

tetrahedronlist An array of tetrahedron corners. The first tetrahedron’s first corner is at index [0], followed by its other three corners, followed by any other nodes if the ‘-o2’ switch is used. Each tetrahedron occupies “numberofcorners” (4 or 10) ints.

tetrahedronattributelist An array of tetrahedron attributes. Each tetrahedron’s attributes occupy “numberoftetrahedronattributes” REALs.

tetrahedronvolumelist An array of tetrahedron volume constraints; one REAL per tetrahedron. Input only.

neighborlist An array of tetrahedron neighbors; four ints per tetrahedron. Output only.

facetlist An array of PLC facets. Each facet is an object of type “facet” (see Section 5.4.2).

facetmarkerlist An array of facet markers; one int per facet.

holelist An array of holes. The first hole's x, y and z coordinates are at indices [0], [1] and [2], followed by the remaining holes. Three REALs per hole.

regionlist An array of regional attributes and volume constraints. The first constraints' x, y and z coordinates are at indices [0], [1] and [2], followed by the regional attribute at index [3], followed by the maximum volume at index [4], followed by the remaining volume constraints. Five REALs per volume constraint. Each regional attribute is used only if the 'A' switch is used, and each volume constraint is used only if the 'a' switch (with no number following) is used, but omitting one of these switches does not change the memory layout.

facetconstraintlist An array of facet maximum area constraints. Two REALs per constraint. The first one is the facet marker (cast the type to integer), the second is its maximum area bound. Note the 'facetconstraintlist' is used only for the 'q' switch.

segmentconstraintlist An array of segment length constraints. Two REALs per constraint. The first one is the index (pointing into 'pointlist') of the node, the second is its maximum length bound. Note the 'segmentconstraintlist' is used only for the 'q' switch.

trifacelist An array of triangular faces. The first face's corners are at indices [0], [1] and [2], followed by the remaining faces. Three ints per face.

trifacemarkerlist An array of face markers; one int per face.

edgelist An array of segment endpoints. The first segment's endpoints are at indices [0] and [1], followed by the remaining segments. Two ints per segment.

edgemarkerlist An array of segment markers; one int per segment.

5.4.1 Memory Management

Two routines defined in tetgenio are used for memory initialization and cleaning. They are:

```
void initialize();
void deinitialize();
```

“initialize()” initializes all fields, that is, all pointers to arrays are initialized to NULL, and other variables are initialized to zero except the variable ‘numberofcorners’, which is 4 (a tetrahedron has 4 nodes). Initialization is implicitly called by the constructor of tetgenio. For an example, the following line creates an object of tetgenio named “io”, all fields of “io” are initialized:

```
tetgenio io;
```

The next step is to allocate memory for each array which will be used. In C++ the memory allocation and deletion can be done by the “new” and “delete” operators. Another pair of functions (preferred by C programmers) are “malloc()” and “free()”. Whatever you use, you must stick with one of these two pairs, e.g., ‘new’/‘delete’ and ‘malloc’/‘free’ can not be mixed. For example, the following line allocates memory for “io.pointlist”:

```
io.pointlist = new REAL[io.numberofpoints * 3];
```

“deinitialize” frees the memory allocated in objects of tetgenio by using ‘delete’. It is automatically called on deletion of the tetgenio objects. If the memory was allocated by using the function “malloc()”, the user is responsible to free it. After having freed all memory, one call of “initialize()” disables the automatic memory deletion.

To reuse an object is possible: first call “deinitialize()”, then call “initialize()” before the next use.

5.4.2 The “facet” Data Structure

The “facet” data structure defined in tetgenio can be used to represent any facet of a PLC. However, to preserve the flexibility, to use is not straightforward.

The structure of facet shown below consists of a list of polygons and a list of hole points.

```
typedef struct {
    polygon *polygonlist;
    int numberofpolygons;
    REAL *holelist;
    int numberofholes;
} facet;
```

A polygon is again an object of type “polygon”. It consists of a list of corner points (“vertexlist”). The structure is shown below.

```

typedef struct {
    int *vertexlist;
    int numberofvertices;
} polygon;

```

In fact, the structure of facet is a direct translation of the facet format in a .poly file, described in Section 3.2.2. The front facet of Figure 20 serves an example for setting a PLC facet into an object of facet. It has two polygons, one has six vertices, and the other is a segment, no holes, the ASCII data is:

```

2
6 4 12 8 5 9 1 # front side
2 12 9

```

The following C++ code does the translation. Assume the object of tetgenio is “io” and has already be created.

```

tetgenio::facet *f; // Define a pointer of facet.
tetgenio::polygon *p; // Define a pointer of polygon.

// All indices start from 1.
io.firstnumber = 1;

...

// Use 'f' to point to a facet of 'facetlist'.
f = &io.facetlist[i];
// Initialize the fields of this facet.
// There are two polygons, no holes.
f->numberofpolygons = 2;
// Allocate memory for polygons.
f->polygonlist = new tetgenio::polygon[2];
f->numberofholes = 0;
f->holelist = NULL;

// Set the data of the first polygon into facet.
p = &f->polygonlist[0];
p->numberofvertices = 6;
// Allocate memory for vertices.
p->vertexlist = new int[6];
p->vertexlist[0] = 4;
p->vertexlist[1] = 12;
p->vertexlist[2] = 8;
p->vertexlist[3] = 5;
p->vertexlist[4] = 9;
p->vertexlist[5] = 1;

// Set the data of the second polygon into facet.

```

```

p = &f->polygonlist[1];
p->numberofvertices = 2;
p->vertexlist = new int[2]; // Alloc. memory for vertices.
p->vertexlist[0] = 12;
p->vertexlist[1] = 9;

```

5.5 An Example

This section gives an example of how to call TetGen from another program by using the “tetgenio” data structure and the function “tetrahedralize()”. The example in Section 4.3.1 (Figure 19) is used again.

The complete C++ source code is given below. It is also available in TetGen’s website:<http://tetgen.berlios.de/files/tetcall.cxx>. The code illustrates the following basic steps:

- at first creates an input object “in” of tetgenio containing the data of the bar;
- then it calls function “tetrahedralize()” to create a quality mesh of the bar with output in “out”.

In addition, It outputs the PLC in the object “in” into two files (barin.node and barin.poly), and outputs the mesh in the object “out” into three files (barout.node, barout.ele, and barout.face). These files can be visualized by TetView.

This example can be compiled into an executable program.

- Compile TetGen into a library named “libtet.a” (see Section 2.1 for compiling);
- Save the file “tetcall.cxx” into the same directory in which you have the files “tetgen.h” and “libtet.a”;
- Compile it using the following command:

```
g++ -o test tetcall.cxx -L./ -ltet
```

which will result an executable file “test”.

The complete source codes are given below:

```

#include "tetgen.h" // Defined tetgenio, tetrahedralize().

int main(int argc, char *argv[])
{
    tetgenio in, out;
    tetgenio::facet *f;
    tetgenio::polygon *p;
    int i;

    // All indices start from 1.
    in.firstnumber = 1;

    in.numberofpoints = 8;
    in.pointlist = new REAL[in.numberofpoints * 3];
    in.pointlist[0] = 0; // node 1.
    in.pointlist[1] = 0;
    in.pointlist[2] = 0;
    in.pointlist[3] = 2; // node 2.
    in.pointlist[4] = 0;
    in.pointlist[5] = 0;
    in.pointlist[6] = 2; // node 3.
    in.pointlist[7] = 2;
    in.pointlist[8] = 0;
    in.pointlist[9] = 0; // node 4.
    in.pointlist[10] = 2;
    in.pointlist[11] = 0;
    // Set node 5, 6, 7, 8.
    for (i = 4; i < 8; i++) {
        in.pointlist[i * 3] = in.pointlist[(i - 4) * 3];
        in.pointlist[i * 3 + 1] = in.pointlist[(i - 4) * 3 + 1];
        in.pointlist[i * 3 + 2] = 12;
    }

    in.numberoffacets = 6;
    in.facetlist = new tetgenio::facet[in.numberoffacets];
    in.facetmarkerlist = new int[in.numberoffacets];

    // Facet 1. The leftmost facet.
    f = &in.facetlist[0];
    f->numberofpolygons = 1;
    f->polygonlist = new tetgenio::polygon[f->numberofpolygons];
    f->numberofholes = 0;
    f->holelist = NULL;
    p = &f->polygonlist[0];
    p->numberofvertices = 4;
    p->vertexlist = new int[p->numberofvertices];
    p->vertexlist[0] = 1;
    p->vertexlist[1] = 2;
    p->vertexlist[2] = 3;

```

```

p->vertexlist[3] = 4;

// Facet 2. The rightmost facet.
f = &in.facetlist[1];
f->numberofpolygons = 1;
f->polygonlist = new tetgenio::polygon[f->numberofpolygons];
f->numberofholes = 0;
f->holelist = NULL;
p = &f->polygonlist[0];
p->numberofvertices = 4;
p->vertexlist = new int[p->numberofvertices];
p->vertexlist[0] = 5;
p->vertexlist[1] = 6;
p->vertexlist[2] = 7;
p->vertexlist[3] = 8;

// Facet 3. The bottom facet.
f = &in.facetlist[2];
f->numberofpolygons = 1;
f->polygonlist = new tetgenio::polygon[f->numberofpolygons];
f->numberofholes = 0;
f->holelist = NULL;
p = &f->polygonlist[0];
p->numberofvertices = 4;
p->vertexlist = new int[p->numberofvertices];
p->vertexlist[0] = 1;
p->vertexlist[1] = 5;
p->vertexlist[2] = 6;
p->vertexlist[3] = 2;

// Facet 4. The back facet.
f = &in.facetlist[3];
f->numberofpolygons = 1;
f->polygonlist = new tetgenio::polygon[f->numberofpolygons];
f->numberofholes = 0;
f->holelist = NULL;
p = &f->polygonlist[0];
p->numberofvertices = 4;
p->vertexlist = new int[p->numberofvertices];
p->vertexlist[0] = 2;
p->vertexlist[1] = 6;
p->vertexlist[2] = 7;
p->vertexlist[3] = 3;

// Facet 5. The top facet.
f = &in.facetlist[4];
f->numberofpolygons = 1;
f->polygonlist = new tetgenio::polygon[f->numberofpolygons];
f->numberofholes = 0;

```



```

f->holelist = NULL;
p = &f->polygonlist[0];
p->numberofvertices = 4;
p->vertexlist = new int[p->numberofvertices];
p->vertexlist[0] = 3;
p->vertexlist[1] = 7;
p->vertexlist[2] = 8;
p->vertexlist[3] = 4;

// Facet 6. The front facet.
f = &in.facetlist[5];
f->numberofpolygons = 1;
f->polygonlist = new tetgenio::polygon[f->numberofpolygons];
f->numberofholes = 0;
f->holelist = NULL;
p = &f->polygonlist[0];
p->numberofvertices = 4;
p->vertexlist = new int[p->numberofvertices];
p->vertexlist[0] = 4;
p->vertexlist[1] = 8;
p->vertexlist[2] = 5;
p->vertexlist[3] = 1;

// Set 'in.facetmarkerlist'

in.facetmarkerlist[0] = -1;
in.facetmarkerlist[1] = -2;
in.facetmarkerlist[2] = 0;
in.facetmarkerlist[3] = 0;
in.facetmarkerlist[4] = 0;
in.facetmarkerlist[5] = 0;

// Output the PLC to files 'barin.node' and 'barin.poly'.
in.save_nodes("barin");
in.save_poly("barin");

// Tetrahedralize the PLC. Switches are chosen to read a PLC (p),
// do quality mesh generation (q) with a specified quality bound
// (1.414), and apply a maximum volume constraint (a0.1).

tetrahedralize("pq1.414a0.1", &in, &out);

// Output mesh to files 'barout.node', 'barout.ele' and 'barout.face'.
out.save_nodes("barout");
out.save_elements("barout");
out.save_faces("barout");

return 0;
}

```

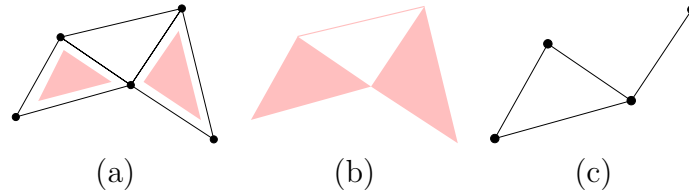

Figure 21: **(a)** A two-dimensional simplicial complex K consists of 2 triangles (which are shaded), 7 edges, and 5 vertices. **(b)** The underlying space. **(c)** A subcomplex, which is a 1-dimensional simplicial complex, consists of 4 edges, and 4 vertices.

A Some Combinatorial Topology

This section gives simplified explanations of some basic notions of combinatorial topology as a quick reference.

Convex Hull The *convex hull* of a set $V \subset \mathbf{R}^n$ of points, denoted $\text{conv}V$, is the smallest convex set that contains V .

Simplex A *simplex* σ is the convex hull of an affinely independent set S of points. The *dimension* of σ is one less than the number of points of S . Specifically, in \mathbf{R}^3 the maximum number of affinely independent points is 4, so we have non-empty simplices of dimensions 0, 1, 2 and 3 referred to as *vertices*, *edges*, *triangles*, and *tetrahedra*, respectively. For any subset $T \subseteq S$, the simplex $\tau = \text{conv}T$ is a *face* of σ and we write $\tau \leq \sigma$. τ is a *proper face* of σ if T is a proper subset of S .

Simplicial Complex A *simplicial complex* K is a finite set of simplices such that (i) any face of a simplex in K is also in K , and (ii) the intersection of any two simplices in K is a face of both. Condition (ii) allows for the case in which two simplices are disjoint because the empty set is the unique (-1)-dimensional simplex, which is a face of any simplex. Figure 21 (a) illustrates a two-dimensional simplicial complex.

Underlying Space The *underlying space* of a set of simplices L , denoted $|L|$, is the union of interiors, $\bigcup_{\sigma \in L} \text{int}\sigma$ (see an illustration in Figure 21 (b)). $|L|$ is a topologically closed set if and only if L is a simplicial complex.

Subcomplex A *subcomplex* of K is a subset of simplices of K that is also a simplicial complex. For an example see Figure 21 (c).

References

- [1] Delaunay Boris N., *Sur la Sphère Vide*. Izvestia Akademia Nauk SSSR, VII Seria, Otdelenie Matematicheskii i Estestvennyka Nauk **7**:793-800, 1934.
- [2] Schönhardt E., *Über die Zerlegung von Dreieckspolyedern in Tetraeder*. Mathematische Annalen **98**:309–312, 1928
- [3] Bagemihl F., *On Indecomposable Polyhedra*. American Mathematical Monthly **55**: 411–413, 1948
- [4] Chazelle B. *Convex Partition of Polyhedra: A lower Bound and Worst-case Optimal Algorithm*. SIAM Journal on Computing **13**(3): 488–507, 1984
- [5] Lawson C. L., *Software for C^1 surface interpolation*. In Mathematical Software III, Academic Press, New York, 161-194, 1977.
- [6] Chew P. L., *Guaranteed-Quality Delaunay Meshing in 3D*. Proc. 13th Annu. ACM Sympos. Comput. Geom., 391–393, 1997.
- [7] Chew L. P., *Constrained Delaunay Triangulation*. Algorithmica **4**(1):97-108, 1989.
- [8] Chew L. P., *Guaranteed-Quality Triangular Meshes*. Technical Report TR-89-983, Department of Computer Science, Cornell University, 1989.
- [9] Chew L. P., *Guaranteed-Quality Mesh Generation for Curved Surfaces*. Proceedings of the 9th Annual Symposium on Computational Geometry, pages 274-280. ACM May, 1993.
- [10] Joe B., *Construction of Three-dimensional Delaunay Triangulations from local transformations*. Computer Aided Geometric Design **8**: 123-142, 1991.
- [11] Shephard M. S. and Georges M. K., *Three-dimensional Mesh Generation by Finite Octree Technique*. J. Numer. Methods in Engineer. **32**: 709–749, 1991.
- [12] Lo S. H., *Volume Discretization into Tetrahedra - II. 3D Triangulation by Advancing Front Approach*. Computers and Structures, **39**: 501–511, 1991.

- [13] Clarkson, K. L., Mehlhorn K., and Seidel R., *Four Results on Randomized Incremental Constructions*. In Symposium on Theoretical Aspects of Computer Science, 1992.
- [14] Ruppert J. and Seidel R., *On the difficulty of triangulating three-dimensional non-convex polyhedra*. Discrete & Computational Geometry **7**: 227-254, 1992.
- [15] Ruppert J. *A Delaunay Refinement Algorithm for Quality Mesh Generation*. Journal of Algorithms **18**(3):548-585, May 1995.
- [16] Rajan V. T., *Optimality of the Delaunay Triangulation in \mathbf{R}^d* . Discrete Comput. Geom. **12**: 189-202, 1994.
- [17] Miller G. L., Talmor D., Teng S.-H., Walkington N., and Wang H., *A Delaunay Based Numerical Method for Three Dimensions: Generation, Formulation, and Partition*. Proceeding of 27th Annual ACM Symposium on the Theory of Computing, pages 683-692, May 1995.
- [18] Barber, C.B., Dobkin, D.P., and Huhdanpaa, H.T., *The Quickhull algorithm for convex hulls*. ACM Trans. on Mathematical Software, 22(4):469-483, Dec 1996, <http://www.qhull.org>.
- [19] Miller G. L., Talmor D., Teng S.-H., Walkington N., and Wang H., *Control Volume Meshes Using Sphere Packing: Generation, Refinement and Coarsening*. Proceeding of 5th International Meshing Roundtable, pages 47-61, 1996.
- [20] Ziegler G. M., *Lectures on Polytopes*. Volume 152 of Graduate Texts in Mathematics. Springer Verlag, New York, 1995.
- [21] Lohner R., *Progress in Grid Generation via the Advancing Front Technique*. Engineering with Computers, **12**: 186–210, 1996
- [22] Edelsbrunner H. and Shah N. R., *Incremental Topological Flipping Works for Regular Triangulations*. Algorithmica **15**: 223-241, 1996.
- [23] Edelsbrunner H., *Geometry and Topology for Mesh Generation*. Cambridge Monographs on Applied and Computational Mathematics; ISBN 0-521-79309-2, 2001.
- [24] Edelsbrunner H., Guoy D., *An Experimental Study of Sliver Exudation*. Engineering With Computers, **18**: 229–240, 2002

- [25] Shewchuk J. R., *Adaptive Precision Floating-Point Arithmetic and Robust Geometric Predicates*. Discrete & Computational Geometry **18**(3):305-363, October 1997. C source code is available at <http://www.cs.cmu.edu/~quake/robust.html>.
- [26] Shewchuk J. R., *A Condition Guaranteeing the Existence of Higher-Dimensional Constrained Delaunay Triangulations*. Proceedings of the Fourteenth Annual Symposium on Computational Geometry (Minneapolis, Minnesota), pages 76-85, 1998.
- [27] Shewchuk J. R., *Tetrahedral Mesh Generation by Delaunay Refinement*. Proceedings of the Fourteenth Annual Symposium on Computational Geometry (Minneapolis, Minnesota), pages 86-95, 1998.
- [28] Shewchuk J. R., *Mesh Generation for Domains with Small Angles*. Proceeding of 16th Annual Symposium on Computational Geometry, 2000.
- [29] Shewchuk J. R., *Constrained Delaunay Tetrahedralizations and Provably Good Boundary Recovery*. Eleventh International Meshing Roundtable (Ithaca, New York), pages 193-204. Sandia National Laboratories, September 2002.
- [30] Shewchuk J. R., *Updating and Constructing Constrained Delaunay Tetrahedralizations by Flips*. Proceeding of 19th Annual Symposium on Computational Geometry, 2003.
- [31] Shewchuk J. R., *General-Dimensional Constrained Delaunay and Constrained Regular Triangulations I: Combinatorial Properties*. To appear in Discrete and Computational Geometry, December 2005.
- [32] Pébay P., *A Priori Delaunay-Conformity*, Proceedings of 7th International Meshing Roundtable, SANDIA, 1998.
- [33] Cheng S. W., Dey T. K., Edelsbrunner H., Facello M. A., And Teng S. H., *Sliver Exudation*. Proc. 15th Ann. Sympos. Comput. Geom., 1999.
- [34] Cheng S. W., Dey T. K., and Ray T., *Weighted Delaunay Refinement for Polyhedra with Small Angles*. To appear in the Proceeding of the Fourth International Meshing Roundtable, September 2005.
- [35] Mitchell S. A. and Vavasis S. A., *Quality Mesh Generation in Higher Dimensions*. SIAM J. Computers, **12**: 186-210, 2000

- [36] Murphy M., Mount D. M. and Gable C. W., *A Point-Placement Strategy for Conforming Delaunay Tetrahedralization*, Proceeding of the Eleventh Annual Symposium on Discrete Algorithms, pages 67-74. Association for Computing Machinery, January 2000.
- [37] Cohen-Steiner D., de Verdière E., and Yvinec M., *Conforming Delaunay Triangulations in 3D*, Proceedings of Eighteenth Annual Symposium on Computational Geometry (Barcelona, Spain). Association for Computing Machinery, June 2002.
- [38] Rambau J. *On a Generalization of Schönhardt's Polyhedron*. MSRI Preprint 2003-13, 2003
- [39] J. A. De Loera, J. Rambau, and F. Santos, *Triangulations: Applications, Structures, Algorithms*.
- [40] Pav S. and Walkington N., *A Robust 3D Delaunay Refinement Algorithm*. Proc. Intl. Meshing Roundtable 2004.
- [41] Si H. and Gärtner K., *An Algorithm for Three-Dimensional Constrained Delaunay Tetrahedralizations*, Proceeding of the Fourth International Conference on Engineering Computational Technology, Lisbon, Portugal, September 2004.
- [42] Si H. and Gärtner K., *Meshing Piecewise Linear Complexes by Constrained Delaunay Tetrahedralizations*, Proceeding of the 14th International Meshing Roundtable, September 2005.