

ARRL Laboratory Expanded Test-Result Report

ICOM IC-746

Prepared by:

American Radio Relay League, Inc.
Technical Department Laboratory
225 Main St.
Newington, CT 06111
Telephone: (860) 594-0214
Internet: mtracy@arrl.org

Order From:

American Radio Relay League, Inc.
Technical Department Secretary
225 Main St.
Newington, CT 06111
Telephone: (860) 594-0278
Internet: reprints@arrl.org

Price:

\$7.50 for ARRL Members, \$12.50 for non-Members, postpaid.

Model Information:

IC-746 Serial #: 001674
QST "Product Review" September, 1998

Manufacturer:

ICOM America
2380 116th Ave NE
PO Box C-90029
Bellevue, WA 98004
Telephone: 425-454-8155

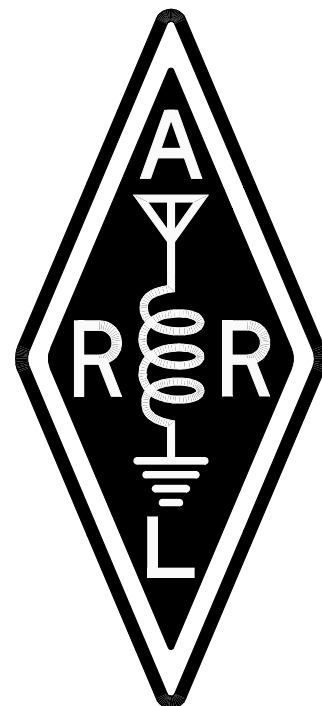

List of Tests:

(Page numbers are omitted because the length of the report varies from unit to unit.)

Introduction

Transmitter Tests:

Transmit Output Power
Transverter Jack Output Power
Current Consumption
Transmit Frequency Range
Spectral Purity
Transmit Two-Tone IMD
Carrier and Sideband Suppression
CW Keying Waveform
Transmit Keyer Speed
SSB/FM Transmit Delay
Transmit/Receive Turnaround
Transmit Composite Noise

Receiver Tests:

Noise Floor (Minimum Discernible Signal)
Receive Frequency Range
AM Sensitivity
FM Sensitivity
Blocking Dynamic Range
Two-Tone, Third-Order Dynamic Range and Intercept Point
Two-Tone, Second-Order Intercept Point
In-Band Receiver IMD
FM Adjacent Channel Selectivity
FM Two-Tone, Third-Order IMD Dynamic Range
Image Rejection
IF Rejection
Audio Output Power
IF + Audio Frequency Response
Squelch Sensitivity
S-Meter Accuracy and Linearity
In-Band Receiver IMD

Introduction:

This document summarizes the extensive battery of tests performed by the ARRL Laboratory for each unit that is featured in *QST* "Product Review." For all tests, there is a discussion of the test and test method used in ARRL Laboratory testing. For most tests, critical conditions are listed to enable other engineers to duplicate our methods. For some of the tests, a block diagram of the test setup is included. The ARRL Laboratory has a document, the *ARRL Laboratory Test Procedures Manual*, that explains our specific test methods in detail, with a test description similar to the one in this report, a block diagram showing the specific equipment currently in use for each test, along with all equipment settings and a specific step by step procedure used in the ARRL Laboratory. While this is not available as a regular ARRL publication, the ARRL Technical Department Secretary can supply a copy at a cost of \$20.00 for ARRL Members, \$25.00 for non-Members, postpaid.

Most of the tests used in ARRL product testing are derived from recognized standards and test methods. Other tests have been developed by the ARRL Lab. The ARRL Laboratory test equipment is calibrated annually, with traceability to National Institute of Standards and Technology (NIST). Most of the equipment is calibrated by a contracted calibration laboratory. Other equipment, especially the custom test fixtures, is calibrated by the ARRL Laboratory Engineers, using calibrated equipment and standard techniques.

The units being tested are operated as specified by the equipment manufacturer. The ARRL screen room has an ac supply that is regulated to 117 or 234 volts. If possible, the equipment under test is operated from the ac supply. Mobile and portable equipment is operated at the voltage specified by the manufacturer, at 13.8 volts if not specified, or from a fully charged internal battery. Equipment that can be operated from 13.8 volts (nominal) is also tested for function, output power and frequency accuracy at the minimum specified voltage, or 11.5 volts if not specified. Units are tested at room temperature and humidity as determined by the ARRL HVAC system. Also, units that are capable of mobile or portable operation are tested at their rated temperature range, or at -10 to +60 degrees Celsius in a commercial temperature chamber.

ARRL "Product Review" testing represents a sample of only one unit (although we sometimes obtain an extra sample or two for comparison purposes). This is not necessarily representative of all units of the same model number. It is not uncommon that some parameters will vary significantly from unit to unit. The ARRL Laboratory and Product Review editor work with manufacturers to resolve any deviation from specifications or other problems encountered in the review process. These problems are documented in the Product Review.

Units used in "Product Review" testing are purchased off the shelf from major distributors. We take all necessary steps to ensure that we do not use units that have been specially selected by the manufacturer. When the review is complete, the unit is offered for sale in an open mail bid, announced regularly in *QST*.

Related ARRL Publications and Products:

The *1998 ARRL Handbook for Radio Amateurs* has a chapter on test equipment and measurements. The book is available for \$32.00 plus \$6 shipping and handling. The *Handbook* is also now available in a convenient, easy to use CD-ROM format. In addition to the complete *Handbook* text and graphics, the CD-ROM includes a search engine, audio clips, zooming controls, bookmarks and clipboard support. The cost is \$49.95 plus \$4.00 shipping and handling. You can order both versions of the *Handbook* from our web page at <http://www.arrl.org>, or contact the ARRL Publications Sales Department at 888-277-289 (toll free). It is also widely stocked by radio and electronic dealers and a few large bookstores.

The ARRL Technical Information Service has prepared an information package that discusses Product Review testing and the features of various types of equipment. Request the "What is the Best Rig To Buy" package from the ARRL Technical Department Secretary. The cost is \$2.00 for ARRL Members, \$4.00 for non-Members, postpaid.

Many *QST* "Product Reviews" have been reprinted in three ARRL publications: The *ARRL Radio Buyers Sourcebook* (order #3452) covers selected Product Reviews from 1970 to 1990. The cost is \$15.00 plus \$4.00 shipping and handling. The *ARRL Radio Buyers Sourcebook Volume II* (order #4211) contains reprints of all of the Product Reviews from 1991 and 1992. The cost is \$15.00 plus \$4.00 shipping and handling. The *VHF/UHF Radio Buyer's Sourcebook* (order #6184) contains nearly 100 reviews of transceivers, antennas, amplifiers and accessories for VHF and above. You can order these books from our Web page or contact the ARRL Publications Sales Department to order a copy.

QST is also available on CD ROM! The 1997 ARRL Periodicals CD ROM (order #6729), the 1996 ARRL Periodicals CD ROM (order #6109) and the 1995 ARRL Periodicals CD ROM (order #5579) each contain a complete copy of all articles from a year's worth of *QST*, the *National Contest Journal* and *QEX* (ARRL's experimenter's magazine). Each CD is available for \$19.95 plus \$4.00 for shipping and handling. Contact the ARRL Publications Sales Department to order a copy.

Older issues of *QST* are also available: *QST View CD-ROMs* come in sets covering either five years each (1990-1994, 1985-1989, 1980-1984, 1975-1979, 1970-1974, 1965-1969 and 1960-1964) or ten years each (1950-1959, 1940-1949 and 1930-39). The price for each set is \$39.95. Shipping and handling for all ARRL CD ROM products is \$4.00 for the first one ordered, \$1.00 for each additional set ordered at the same time.

Additional test result reports are available for:

| Manufacturer | Model | Issue |
|--------------|-------------|---------|
| Alpha Power | 91B | Sep 97 |
| Ameritron | AL-800H | Sep 97 |
| ICOM | IC-706 | Mar 96 |
| | IC-706 MkII | Jan 98 |
| | IC-746 | Sep 98 |
| | IC-756 | May 97 |
| | IC-775DSP | Jan 96 |
| | IC-821H | Mar 97 |
| | JRC | NRD-535 |
| Kenwood | TS-570D | Jan 97 |
| | TS-870S | Feb96 |
| QRO | HF-2500DX | Sep 97 |
| Ten-Tec | Centaur | Jun 97 |
| | Omni VI + | Nov 97 |
| Yaesu | FT-847 | Jul 98 |
| | FT-920 | Oct 97 |
| | FT-1000MP | Apr 96 |

The cost is \$7.50 for ARRL Members, \$12.50 for non-Members for each report, postpaid. ARRL Members can obtain any three reports for \$20.00, postpaid.

Transmitter Output Power:

Test description: One of the first things an amateur wants to know about a transmitter or transceiver is its RF output power. The ARRL Lab measures the CW output power for every band on which a transmitter can operate. The unit is tested across the entire amateur band and the worst-case number for each band is reported. The equipment is also tested on one or more bands for any other mode of operation for which the transmitter is capable. Typically, the most popular band of operation for each mode is selected. Thus, on an HF transmitter, the SSB tests are done on 75 meters for lower sideband, 20 meters for upper sideband, and AM tests are done on 75 meters, FM tests are done on 10 meters, etc. This test also compares the accuracy of the unit's internal output-power metering against the ARRL Laboratory's calibrated test equipment.

The purpose of the Transmitter Output-Power Test is to measure the dc current consumption at the manufacturer's specified dc-supply voltage, if applicable, and the RF output power of the unit under test across each band in each of its available modes. A two-tone audio input, at a level within the manufacturer's microphone-input specifications, is used for the SSB mode. No modulation is used in the AM and FM modes.

Many transmitters are derated from maximum output power on full-carrier AM and FM modes. In most cases, a 100-watt CW/SSB transmitter may be rated at 25 watts carrier power on AM. The radio may actually deliver 100 watts PEP in AM or FM but is not specified to deliver that power level for any period of time. In these cases, the published test-result table will list the AM or FM power as being "as specified."

In almost all cases, the linearity of a transmitter decreases as output power increases. A transmitter rated at 100 watts PEP on single sideband may actually be able to deliver more power, but as the power is increased beyond the rated RF output power, adjacent channel splatter (IMD) usually increases dramatically. If the ARRL Lab determines that a transmitter is capable of delivering its rated PEP SSB output, the test-result table lists the power as being "as specified."

Key Test Conditions:

Termination: 50 ohms resistive, or as specified by the manufacturer.

Block Diagram:

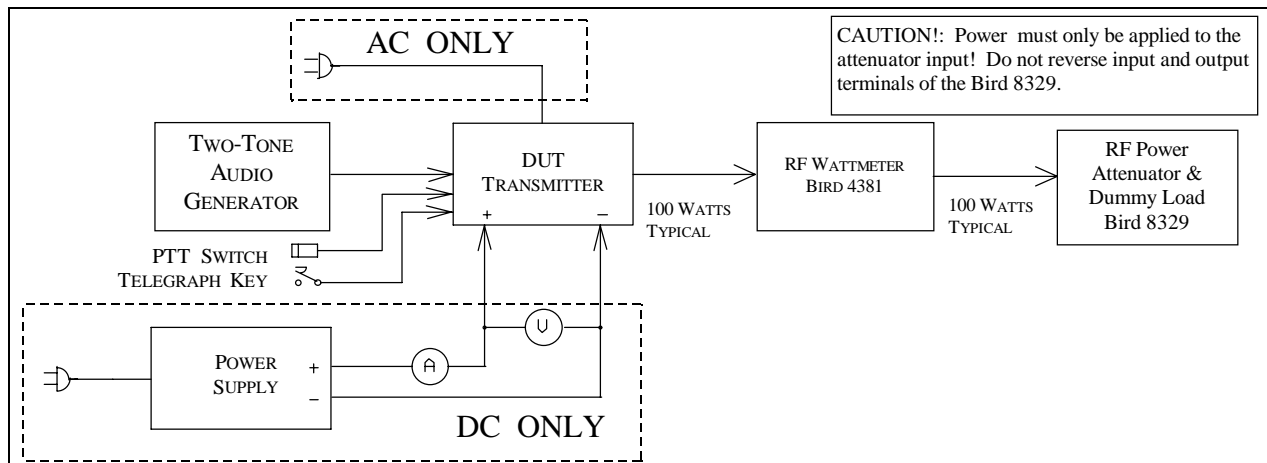

Transmitter Output Power Test Results:

| Frequency Band | Mode | Unit Minimum Power (W) | Measured Minimum Power (W) | Unit Maximum Power (W) | Measured Maximum Power (W) | Notes |
|----------------|------|------------------------|----------------------------|------------------------|----------------------------|-------|
| 1.8 MHz | CW | See note 1 | 1.6 W | “100” | 115 W | 1, 2 |
| 3.5 MHz | CW | – | 1.7 | – | 117 | |
| 3.5 MHz | AM | – | 1.5 | – | 42.8 W carrier | |
| 7.0 MHz | CW | – | 1.8 | – | 117 | |
| 10.1 MHz | CW | – | 1.8 | – | 118 | |
| 14 MHz | CW | – | 1.8 | – | 118 | |
| 14 MHz | USB | – | 1.8 | – | 115 | |
| 18 MHz | CW | – | 1.8 | – | 117 | |
| 21 MHz | CW | – | 1.8 | – | 118 | |
| 24 MHz | CW | – | 1.8 | – | 116 | |
| 28 MHz | CW | – | 1.8 | – | 113 | |
| 28 MHz | FM | – | – | – | 110 | |
| 50 MHz | CW | – | 1.5 | – | 105 | |
| 50 MHz | FM | – | – | – | 102 | |
| 50 MHz | AM | – | – | – | 40.2 W carrier | |
| 50 MHz | SSB | – | – | – | 104 | |
| 144 MHz | CW | – | 1.8 | – | 93 | |
| 144 MHz | FM | – | – | – | 94 | |
| 144 MHz | AM | – | – | – | 41.6 W carrier | |
| 144 MHz | SSB | – | – | – | 93 | |

Notes:

- Unit's power meter consists of LED segments; minimum power showed 0 segments lit.
- The unit showed LED segments reaching a fixed display label reading 100 at full power.
- Temperature chamber tests and 11.5 volt tests are performed *only* for portable and mobile equipment.

Current Consumption Test: (DC-powered units only)

Test Description: Current consumption can be an important to the success of mobile and portable operation. While it is most important for QRP rigs, the ARRL Lab tests the current consumption of all equipment that can be operated from a battery or 12-14 vdc source. The equipment is tested in transmit at maximum output power. On receive, it is tested at maximum volume, with no input signal, using the receiver's broadband noise. Any display lights are turned on to maximum brightness, if applicable. This test is not performed on equipment that can be powered only from the ac mains.

Current Consumption:

| Voltage | Transmit Current | Output Power | Receive Current | Lights? | Notes |
|---------|------------------|--------------|-----------------|---------|-------|
| 13.8 V | 20 A | 100.2 W | 2.5 A | ON | |

Transmit Frequency Range Test:

Test Description: Many transmitters can transmit outside the amateur bands, either intentionally, to accommodate MARS operation, for example, or unintentionally as the result of the design and internal software. The ARRL Lab tests the transmit frequency range inside the screen room. The purpose of the Transmit Frequency Range Test is to determine the range of frequencies, including those outside amateur bands, for which the transmitter may be used. The key test conditions are to test it at rated power, using nominal supply voltages. Frequencies are as indicated on the transmitter frequency indicator or display. Most modern synthesized transmitters are capable of operation outside the ham bands. However, spectral purity is not always legal outside the hams bands, so caution must be used. In addition, most other radio services require that transmitting equipment be type accepted for that service. Amateur equipment is not legal for use on other than amateur and MARS frequencies.

Test Results:

| Frequency | Low-Frequency Limit | High-Frequency Limit | Notes |
|-----------|---------------------|----------------------|-------|
| 160 M | 1.800.00 MHz | 1.999 999 MHz | |
| 80 M | 3.400.00 MHz | 4.099 999 MHz | |
| 40 M | 6.900.00 MHz | 7.499 999 MHz | |
| 30 M | 9.900.00 MHz | 10.499 999 MHz | |
| 20 M | 13.900.00 MHz | 14.499 999 MHz | |
| 17 M | 17.900.00 MHz | 18.499 999 MHz | |
| 15 M | 20.900.00 MHz | 21.499 999 MHz | |
| 12 M | 24.400.00 MHz | 25.099 999 MHz | |
| 10 M | 28.000.00 MHz | 29.999 999 MHz | |
| 6 M | 50.000.00 MHz | 54.000 000 MHz | |
| 2 M | 144.000.00 MHz | 148.000 000 MHz | |

CW Transmit Frequency Accuracy Test:

Test Description: Most modern amateur equipment is surprisingly accurate in frequency. It is not uncommon to find equipment operating within a few Hz of the frequency indicated on the frequency display. However, some units, notably "analog" units, not using a phase-lock loop in the VFO design, can be off by a considerable amount. This test measures the output frequency. Unit is operated into a 50-ohm resistive load at nominal temperature and supply voltage. Frequency is also measured at minimum output power, low supply voltage (12 volt units only) and over the operating temperature range (mobile and portable units only). Non-portable equipment is not tested in the temperature chamber.

Test Results:

| Unit Frequency | Supply Voltage | Temperature | Measured Frequency Full Output Power | Notes |
|----------------|----------------|-------------|--------------------------------------|-------|
| 14.000.00 MHz | 13.8 V | 25 C | 14.000.027 MHz | |

Spectral Purity Test:

Test Description: All transmitters emit some signals outside their assigned frequency or frequency range. These signals are known as spurious emissions or "spurs." Part 97 of the FCC rules and regulations specify the amount of spurious emissions that can be emitted by a transmitter operating in the Amateur Radio Service. The ARRL Laboratory uses a spectrum analyzer to measure the spurious emission on each band on which a transmitter can operate. The transmitter is tested across the band and the worst-case spectral purity on each band is captured from the spectrum analyzer and stored on disk. Spectral purity is reported in dBc, meaning dB relative to the transmitted carrier.

The graphs and tables indicate the relative level of any spurious emissions from the transmitter. The lower that level, expressed in dB relative to the output carrier, the better the transmitter is. So a transmitter whose spurious emissions are -60 dBc is spectrally cleaner than is one whose spurious emissions are -30 dBc. FCC Part 97 regulations governing spectral purity are contained in 97.307 of the FCC rules. Information about all amateur rules and regulations is found in the *ARRL FCC Rule Book*. Additional information about the decibel is found in the *ARRL Handbook*.

Key Test Conditions:

Unit is operated at nominal supply voltage and temperature.

Output power is adjusted to full power on each amateur band.

A second measurement is taken at minimum power to ensure that the spectral output is still legal at low power.

The level to the spectrum analyzer is -10 dBm maximum.

The resolution bandwidth of the spectrum analyzer is 10 kHz on HF, 100 kHz on VHF, MHz on UHF.

Block Diagram:

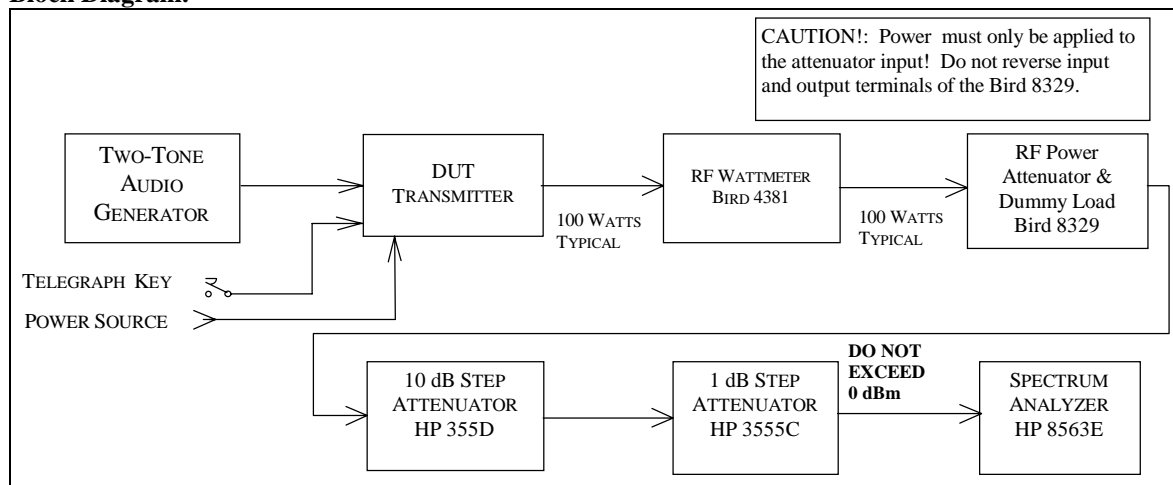

Spectral-Purity Graphs:

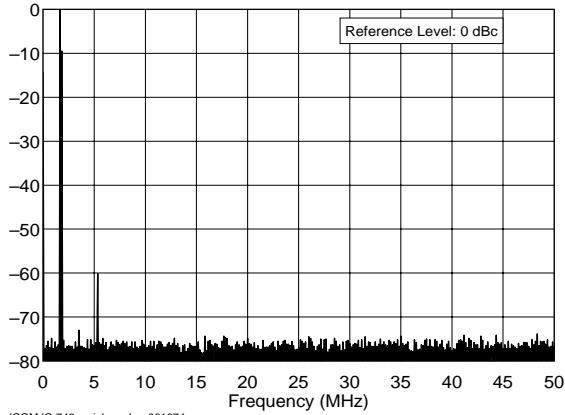

ICOM IC-746 serial number 001674
1.8 MHz Band, Spectral Purity, 100 W
F:\SHARED\PROD_REV\TESTS\IC746\IC746SLO.TXT

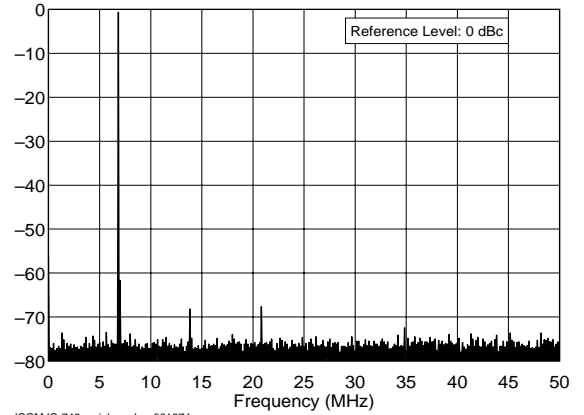

ICOM IC-746 serial number 001674
7.0 MHz Band, Spectral Purity, 100 W
F:\SHARED\PROD_REV\TESTS\IC746\IC746S40.TXT

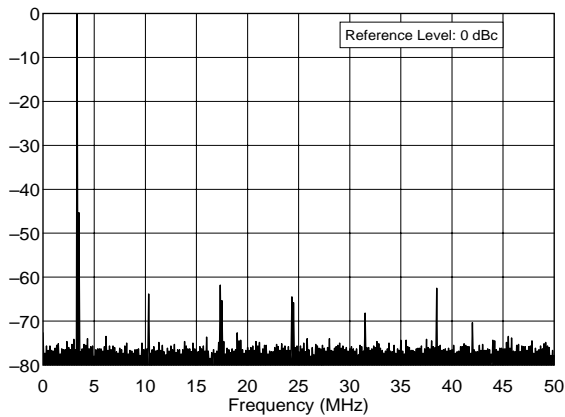

ICOM IC-746 serial number 001674
3.5 MHz Band, Spectral Purity, 100 W
F:\SHARED\PROD_REV\TESTS\IC746\IC746S80.TXT

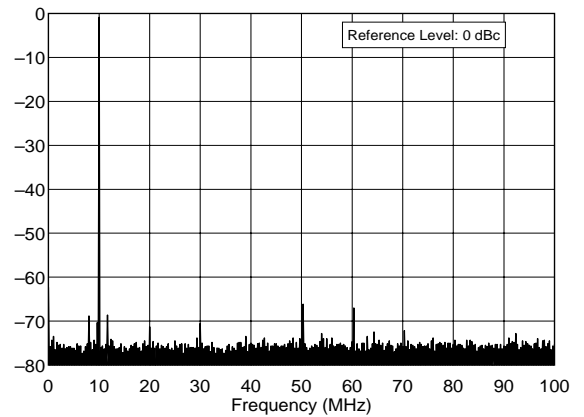

ICOM IC-746 serial number 001674
10.1 MHz Band, Spectral Purity, 100 W
F:\SHARED\PROD_REV\TESTS\IC746\IC746S30.TXT

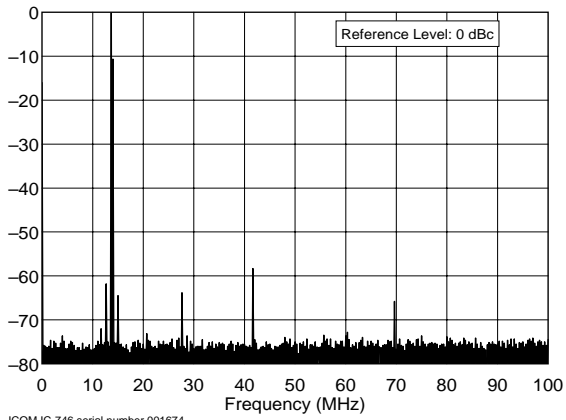

ICOM IC-746 serial number 001674
 14.0 MHz Band, Spectral Purity, 100 W
 F:\SHARED\PROD_REV\TESTS\IC746\IC746S20.TXT

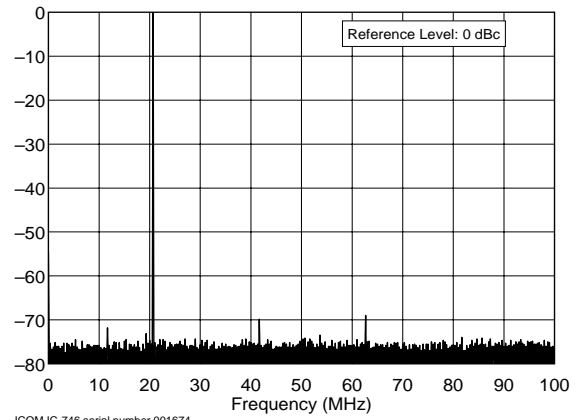

ICOM IC-746 serial number 001674
 21.0 MHz Band, Spectral Purity, 100 W
 F:\SHARED\PROD_REV\TESTS\IC746\IC746S15.TXT

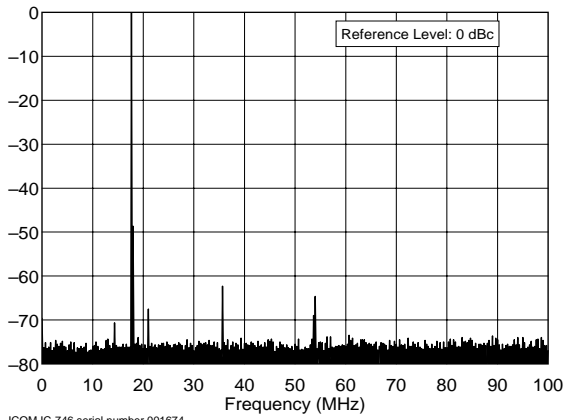

ICOM IC-746 serial number 001674
 18.1 MHz Band, Spectral Purity, 100 W
 F:\SHARED\PROD_REV\TESTS\IC746\IC746S17.TXT

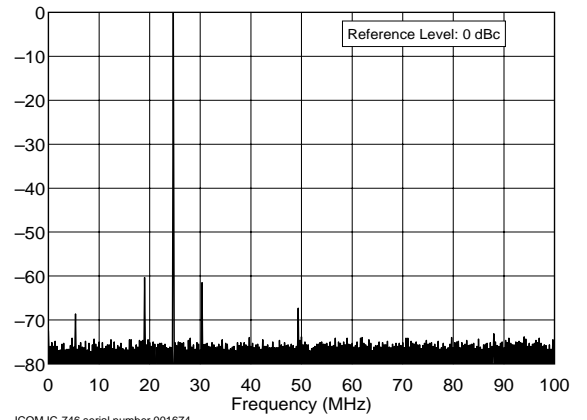

ICOM IC-746 serial number 001674
 24.9 MHz Band, Spectral Purity, 100 W
 F:\SHARED\PROD_REV\TESTS\IC746\IC746S12.TXT

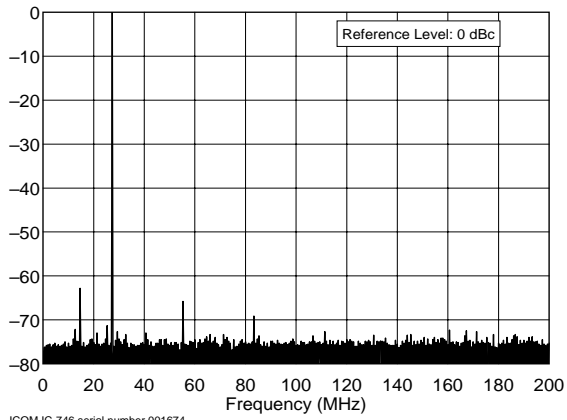

ICOM IC-746 serial number 001674
 28.0 MHz Band, Spectral Purity, 100 W
 F:\SHARED\PROD_REV\TESTS\IC746\IC746S10.TXT

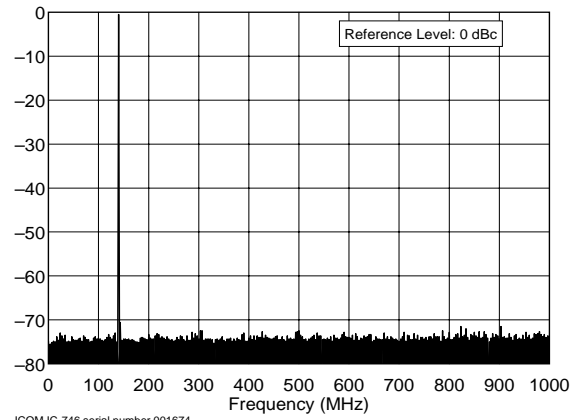

ICOM IC-746 serial number 001674
 144.0 MHz Band, Spectral Purity, 100 W
 F:\SHARED\PROD_REV\TESTS\IC746\IC746S2M.TXT

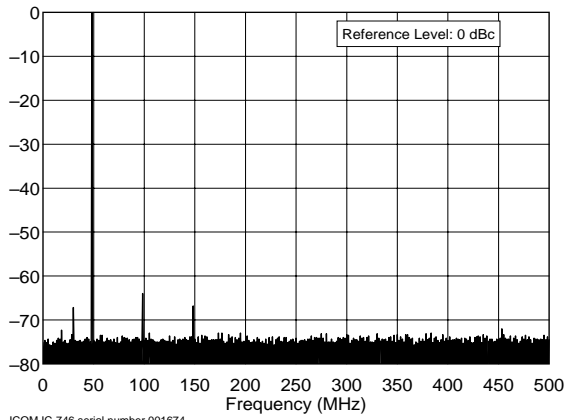

ICOM IC-746 serial number 001674
 50.0 MHz Band, Spectral Purity, 100 W
 F:\SHARED\PROD_REV\TESTS\IC746\IC746S6M.TXT

Transmit Two-Tone IMD Test:

Test Description: Investigating the sidebands from a modulated transmitter requires a narrow-band spectrum analysis. In this test, a two-tone test signal is used to modulate the transmitter. The display shows the two test tones plus some of the IMD products produced by the SSB transmitter. In the ARRL Lab, a two-tone test signal with frequencies of 700 and 1900 Hz is used to modulate the transmitter. These frequencies were selected to be within the audio passband of the typical transmitter, resulting in a meaningful display of transmitter IMD. The intermodulation products appear on the spectral plot above and below the two tones. The lower the intermodulation products, the better the transmitter. In general, it is the products that are farthest removed from the two tones (typically > 3 kHz away) that cause the most problems. These can cause splatter up and down the band from strong signals.

Key Test Conditions:

Transmitter operated at rated output power. Audio tones and drive level adjusted for best performance. Audio tones 700 and 1900 Hz. Both audio tones adjusted for equal RF output. Level to spectrum analyzer, -10 dBm nominal, -10 dBm maximum. Resolution bandwidth, 10 Hz

Block Diagram:

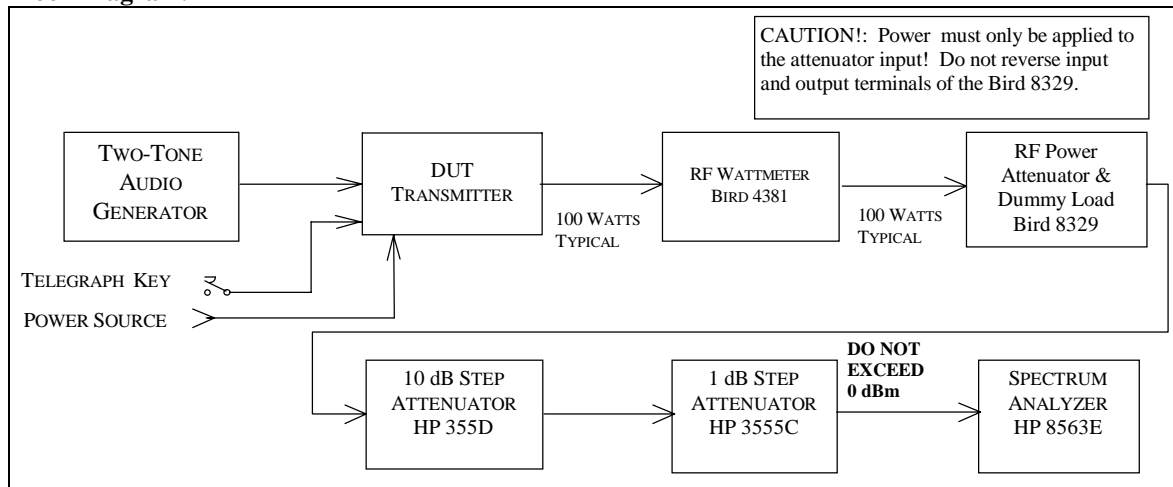

Transmit IMD Graphs

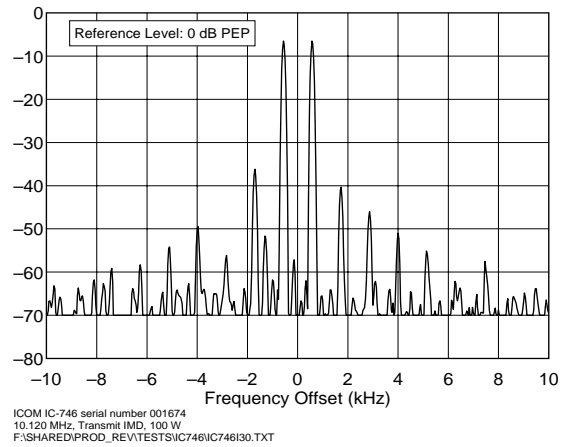
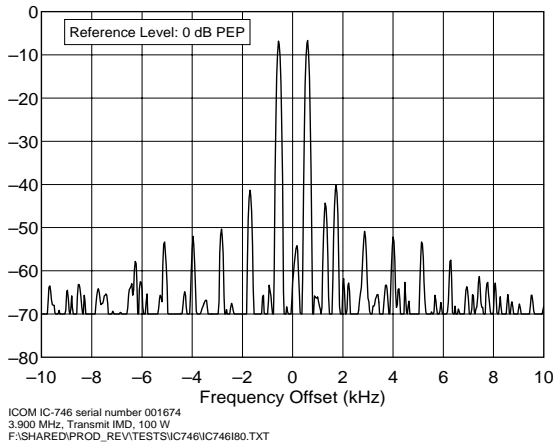
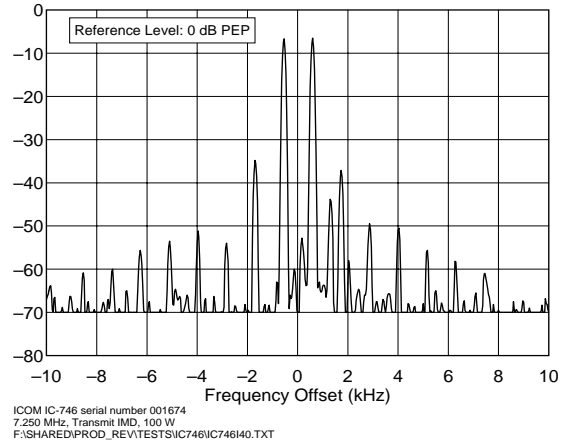
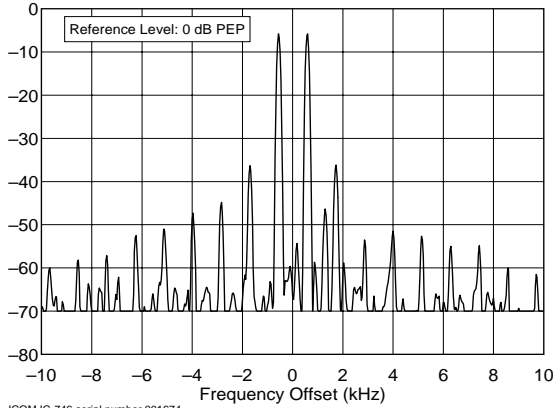

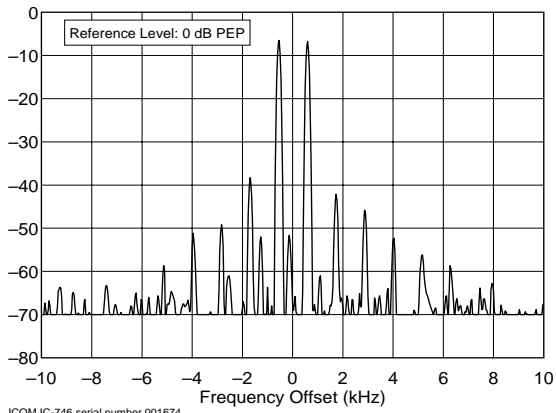

ICOM IC-746 serial number 001674
 14.250 MHz, Transmit IMD, 100 W
 F:\SHARED\PROD_REV\TESTS\IC746\IC746I20.TXT

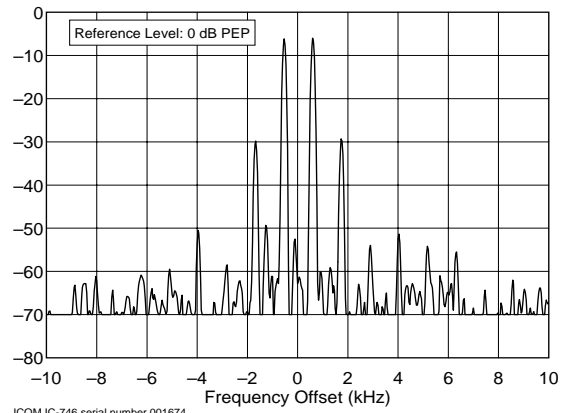

ICOM IC-746 serial number 001674
 21.250 MHz, Transmit IMD, 100 W
 F:\SHARED\PROD_REV\TESTS\IC746\IC746I15.TXT

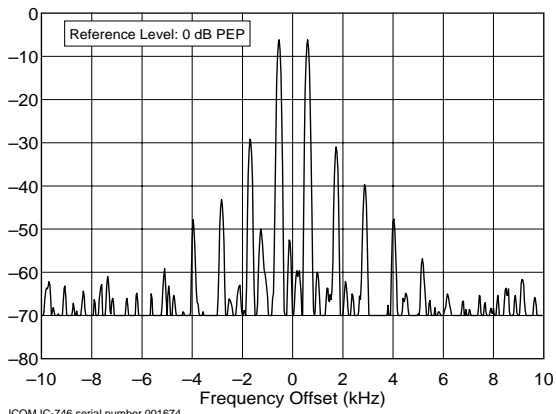

ICOM IC-746 serial number 001674
 18.120 MHz, Transmit IMD, 100 W
 F:\SHARED\PROD_REV\TESTS\IC746\IC746I17.TXT

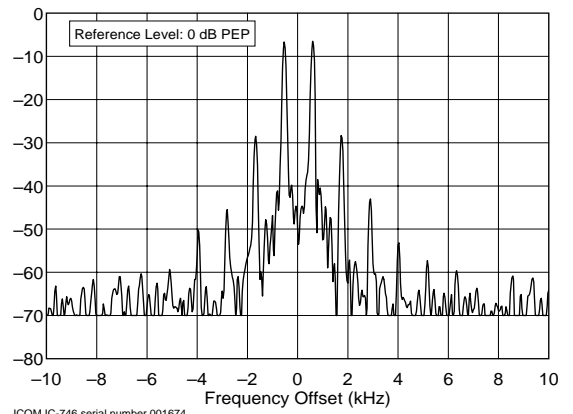

ICOM IC-746 serial number 001674
 24.850 MHz, Transmit IMD, 100 W
 F:\SHARED\PROD_REV\TESTS\IC746\IC746I12.TXT

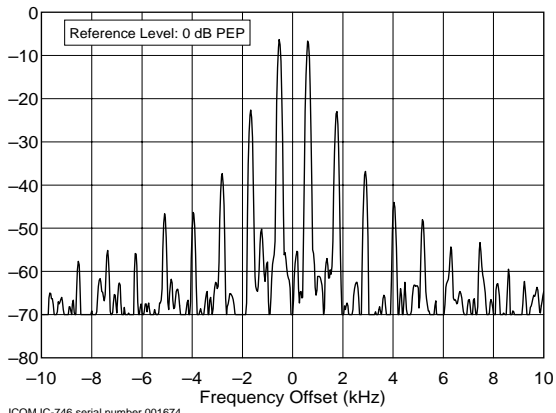

ICOM IC-746 serial number 001674
 28.350 MHz, Transmit IMD, 100 W
 F:\SHARED\PROD_REV\TESTS\IC746\IC746I10.TXT

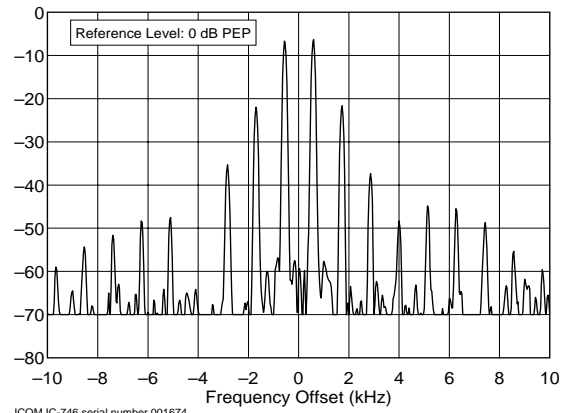

ICOM IC-746 serial number 001674
 144.200 MHz, Transmit IMD, 100 W
 F:\SHARED\PROD_REV\TESTS\IC746\IC746I2M.TXT

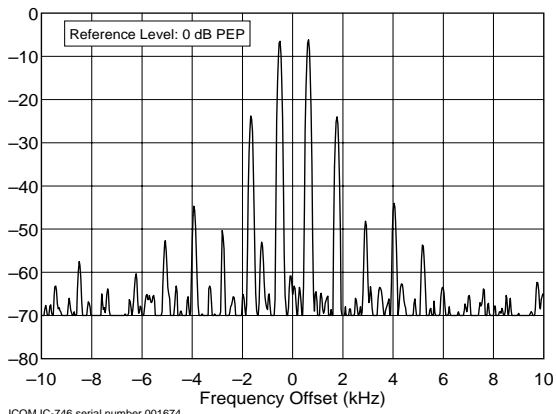

ICOM IC-746 serial number 001674
 50.200 MHz, Transmit IMD, 100 W
 F:\SHARED\PROD_REV\TESTS\IC746\IC746I6M.TXT

SSB Carrier and Unwanted Sideband Suppression Test:

Test Description: The purpose of the SSB Carrier and opposite-sideband Suppression test is to determine the level of carrier and unwanted sideband suppression relative to Peak Envelope Power (PEP). The transmitter output is observed on the spectrum analyzer and the unwanted components are compared to the desired sideband. The level to the spectrum analyzer is -10 dBm nominal. The measurement bandwidth is 100 Hz. The greater the amount of suppression, the better the transmitter. For example, opposite sideband suppression of 60 dB is better than suppression of 50 dB.

Test Results:

| Frequency | Carrier Suppression | Opposite Sideband Suppression | Notes |
|-------------------|---------------------|-------------------------------|-------|
| 14.2 MHz USB/LSB | < -50/-44 dB PEP | < -70/-70 dB PEP | |
| 50.2 MHz USB/LSB | < -60/-65 dB PEP | < -70/-70 dB PEP | |
| 144.2 MHz USB/LSB | < -58/-56 dB PEP | < -70/-70 dB PEP | |

CW Keying Waveform Test:

Test Description: The purpose of the CW Keying Waveform Test is to determine the rise and fall times for the 10% to the 90% point of the device under test's RF output envelope in the CW mode. The on and off delay times from key closure to RF output are also measured. If the transmitter under test has several CW modes, (i.e. VOX, QSK) these measurements is made at rated output power for each mode. A picture of the oscilloscope screen is taken of the results with the QSK off, and in the VOX mode showing the first dit, and any other test conditions that result in a waveshape that is significantly different from the others (more than 10% difference, spikes, etc.). The first and second dits are shown in all modes.

If the risetime or falltime become too short, the transmitter will generate key clicks. Most click-free transmitters have a rise and fall time between 1 ms and 5 ms. The absolute value of the on delay and off delay are not critical, but it is important that they be approximately the same so that CW weighting will not be affected.

Some transmitters used in the VOX mode exhibit a first dit that is shorter than subsequent dits. Other transmitters can show significant shortening of all dits when used in the QSK mode. The latter will cause keying to sound choppy.

The first dit foreshortening is expressed as a "weighting" number. In perfect keying, the weighting is 50%, meaning that the carrier is ON for 50% of the time.

Key Test Conditions:

The transmitter is operated at room temperature at rated output power into a 50-ohm resistive load. The power supply voltage is nominal. Attenuators are adjusted to obtain 3 volts RMS to the oscilloscope.

Test Result Summary:

| Frequency | Mode | First Dit Risetime | First Di Falltime | Subsequent Dits Risetime | Subsequent Dits Falltime | On Delay | Off Delay | Weighting % | First Dit Weighting % |
|-----------|----------|--------------------|-------------------|--------------------------|--------------------------|----------|-----------|-------------|-----------------------|
| 14.02 MHz | Semi-QSK | 1.0 ms | 1.5 ms | 2.0 ms | 1.5 ms | 9 ms | 3 ms | 44.4% | 41.7% |
| 14.02 MHz | QSK | 1.0 ms | 1.5 ms | 2.0 ms | 1.5 ms | 9 ms | 3 ms | 34.7% | 41.7% |

Captions (Figures on next pages): All Figures are 10 ms/division., unless otherwise noted.

Figure 1. This shows the first and second dits in semi break-in mode.

Figure 2. This shows the first and second dits in full break-in mode (QSK).

CW Keying Waveforms:

Figure 1

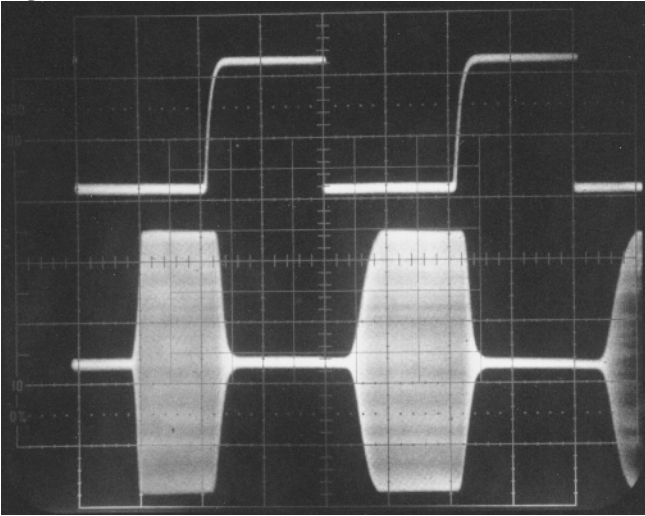
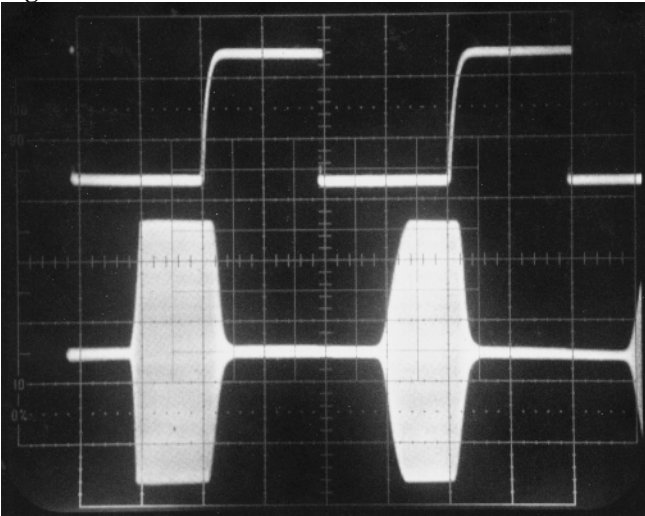

Figure 2



Transmit Keyer Speed Test:

Test Description: This test measures the speed of the internal keyer on transmitters so equipped. The keyer is tested at minimum, midrange and maximum speeds and the time from dit to dit is measured using an oscilloscope and used to calculate the speed using the "Paris" method of code speed calculation. (In the Paris method, the word "Paris" is used as the standard word to calculate words per minute.)

Test Results:

| Min WPM | Max WPM | Mid WPM | Notes |
|---------|---------|---------|-------|
| 6 wpm | 67 wpm | 25 wpm | |

Notes:

Keying sidetone test:

Test Description: This test measures the audio frequency of the keyer sidetone.

Test Result:

| Default pitch | Minimum | Maximum | Notes |
|---------------|---------|---------|-------|
| 700 Hz | 298 Hz | 893 Hz | |

Notes:

Transmit/Receive Turnaround Test:

Test Description: The purpose of the Transmit/Receive turnaround test is to measure the delay required to switch from the transmit to the receive mode of a transceiver.

Test Results:

| Frequency | Conditions | T/R Delay AGC Fast | T/R Delay AGC Slow | Notes |
|-----------|------------|--------------------|--------------------|-------|
| 14.2 MHz | 50% audio | 21.0 ms | 21.0 ms | 1, 2 |

Notes:

1. T/R delay less than or equal to 35 ms is suitable for use on AMTOR.
2. Times on 6M and 2M are similar.

Transmit Delay Test

Test Description: The purpose of the Transmit Delay test is to measure the time between PTT closure and 50% RF output. It is measured on SSB, modulated with a single tone and on FM, unmodulated.

Test Result

| Frequency | Mode | On delay | Off delay | Notes |
|-----------|------|----------|-----------|-------|
| 14.2 MHz | SSB | 8.0 ms | 5.6 ms | |
| 29.2 MHz | FM | 36 ms | 6.0 ms | |
| 50.2 MHz | FM | 30 ms | 5.6 ms | |
| 144.2 MHz | FM | 36 ms | 6.0 ms | |

Notes:

Transmit Composite Noise Test:

Test Description: The purpose of the Composite-Noise Test is to observe and measure the phase and amplitude noise, as well as any spurious signals generated by the device under test transmitter. Since phase noise is the primary noise component in any well-designed transmitter, it can be assumed, therefore, that almost all the noise observed during this test is phase noise. This measurement is accomplished by converting the output of the transmitter down to a frequency about 10 or 20 Hz above baseband. A mixer and a signal generator used as a local oscillator are used to perform this conversion. Filters remove the 0 Hz component as well as the unwanted heterodyne components. The remaining noise and spurious signals are then observed on the spectrum analyzer. The lower the noise as seen on the plot, the better the transmitter.

Key Test Conditions:

- Transmitter operated at rated output power into a 50-ohm resistive load.
- Transmitter operated at room temperature.
- Frequencies from 2 to 22 kHz from the carrier are measured.
- Ten sweeps are averaged on the spectrum analyzer to reduce noise.

Block Diagram:

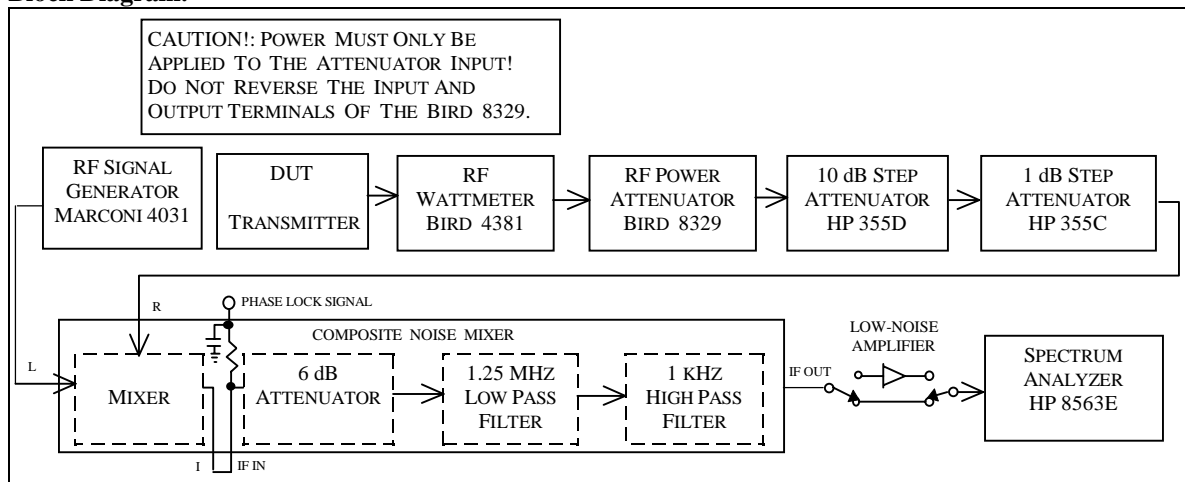

Notes:

Transmit Composite Noise Graphs:

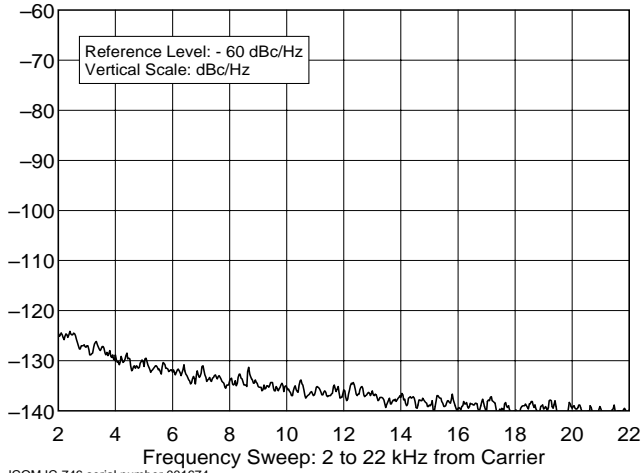

ICOM IC-746 serial number 001674
3.520 MHz, Phase Noise, 100 W
F:\SHARED\PROD_REVTESTS\IC746\IC746P80.TXT

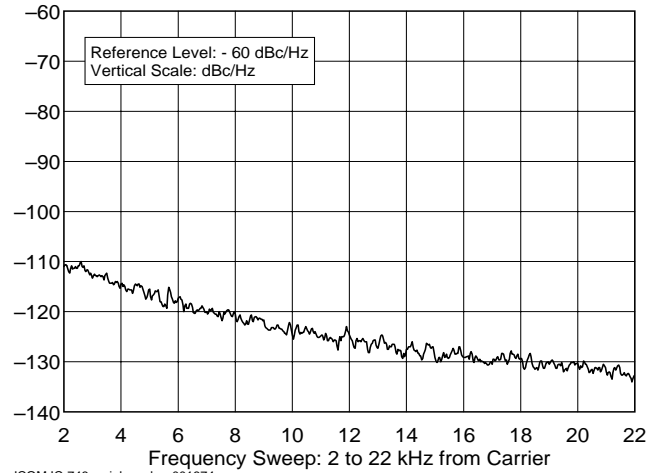

ICOM IC-746 serial number 001674
50.020 MHz, Phase Noise, 100 W
F:\SHARED\PROD_REVTESTS\IC746\IC746P6M.TXT

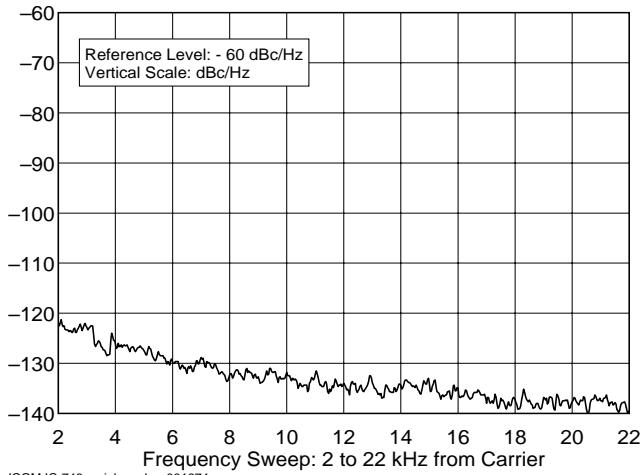

ICOM IC-746 serial number 001674
14.020 MHz, Phase Noise, 100 W
F:\SHARED\PROD_REVTESTS\IC746\IC746P20.TXT

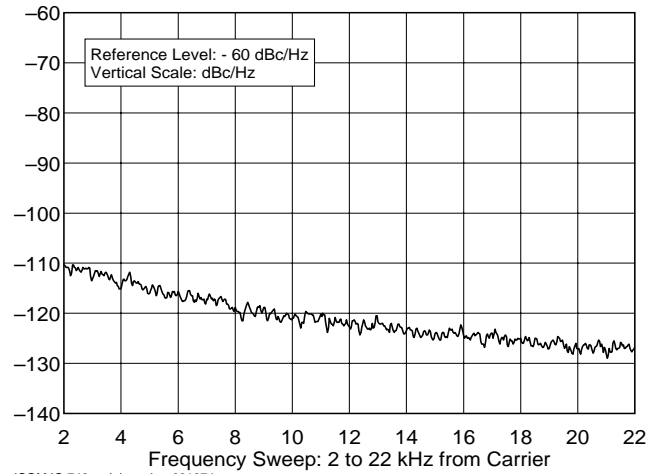

ICOM IC-746 serial number 001674
144.020 MHz, Phase Noise, 100 W
F:\SHARED\PROD_REVTESTS\IC746\IC746P2M.TXT

Receiver Noise Floor (Minimum Discernible Signal) Test:

Test Description: The noise floor of a receiver is the level of input signal that gives a desired audio output level that is equal to the noise output level. This is sometimes called "minimum discernible signal" (MDS), although a skilled operator can detect a signal up to 10 dB or so below the noise floor. Most modern receivers have a noise floor within a few dB of "perfect." A perfect receiver would hear only the noise of a resistor at room temperature. However, especially for HF receiving systems, the system noise is rarely determined by the receiver. In most cases, external noise is many dB higher than the receiver's internal noise. In this case, it is the external factors that determine the system noise performance. Making the receiver more sensitive will only allow it to hear more noise. It will also be more prone to overload. In many cases, especially in the lower HF bands, receiver performance can be improved by sacrificing unneeded sensitivity by placing an attenuator in front of the receiver. The more negative the sensitivity number expressed in dBm, or the smaller the number expressed in voltage, the better the receiver.

Key Test Conditions:

50-ohm source impedance for generators.; Receiver audio output to be terminated with specified impedance.
Receiver is tested using 500 Hz bandwidth, or closest available bandwidth to 500 Hz.

Block Diagram:

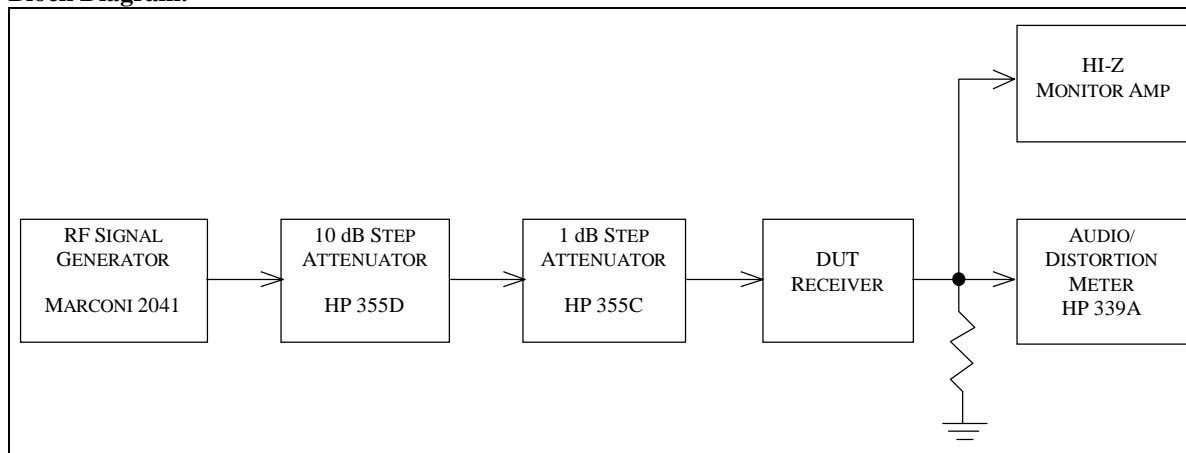

Noise Floor:

| Frequency | Preamp OFF MDS (dBm) | Preamp One MDS (dBm) ⁶ | Preamp Two MDS (dBm) ⁷ | Notes |
|------------|-------------------------|--------------------------------------|--------------------------------------|-------|
| 1.02 MHz | -123.0 | N/A | N/A | 1 |
| 1.82 MHz | -131.3 | -139.2 | -142.1 | |
| 3.52 MHz | -132.3 | -139.6 | -142.6 | |
| 7.02 MHz | -133.4 | -140.2 | -143.7 | |
| 10.12 MHz | -132.6 | -139.3 | -142.0 | |
| 14.02 MHz | -132.4 | -139.2 | -142.6 | |
| 18.1 MHz | -132.5 | -138.2 | -142.1 | |
| 21.02 MHz | -132.3 | -138.9 | -143.3 | |
| 24.91 MHz | -131.2 | -138.4 | -142.2 | |
| 28.02 MHz | -131.3 | -139.5 | -142.9 | |
| 50.02 MHz | -129.4 | -138.4 | -140.7 | |
| 144.02 MHz | -134.2 | -139.1 | N/A | 5 |

Notes:

1. Preamp not selectable on 1 MHz.
5. Only one 2M preamp.
6. Preamp One's design range is 1.8-54 MHz.
7. Preamp Two's design range is 21-60 MHz, but some amplification is provided on lower frequencies.

Receive Frequency Range:

Test Description: This test measures the tuning range of the receiver. The range expressed is the range over which the receiver can be tuned. Most receivers exhibit some degradation of sensitivity near the limits of their tuning range. In cases where this degradation renders the receiver unusable, we report both the actual and useful tuning range.

Test Results:

| Minimum Frequency | Minimum Frequency MDS | Maximum Frequency | Maximum Frequency MDS | Notes |
|-------------------|-----------------------|-------------------|-----------------------|-------|
| 30 kHz | -70.5 dBm | 174.000.00 MHz | -139.0 dBm | 1 |

Notes:

1. Tuning ranges: 30 kHz - 60 MHz, 108 MHz - 174 MHz.

Test Results

| Frequency | Sensitivity Preamp OFF | Notes |
|------------|------------------------|-------|
| 30 kHz | -70.5 dBm | |
| 100 kHz | -105.0 | |
| 200 kHz | -112.6 | |
| 500 kHz | -119.0 | |
| 57 MHz | -118.5 | 1 |
| 59.995 MHz | -106.0 | 2 |
| 108 MHz | -139.0 | |
| 174 MHz | -139.0 | |

Notes:

1. Sensitivity degrades gradually between 57 and 60 MHz.
2. There is an S8 birdie on 60.0 MHz exactly.

AM Sensitivity Test:

Test Description: The purpose of the AM receive Sensitivity Test is to determine the level of an AM signal, 30% modulated at 1 kHz, that results in a tone 10 dB above the noise level (MDS) of the receiver. Two frequencies, 1.020 MHz and 3.800 MHz are used for this test. The more negative the number, expressed in dBm, or the smaller the number expressed in voltage, the better the sensitivity.

Test Results:

| Frequency | Preamplifier | μV | Notes |
|-----------------------|--------------|---------------|-------|
| 1.02 MHz | OFF | 4.12 | |
| 1.02 MHz | ONE | N/A | 1 |
| 1.02 MHz | TWO | N/A | 1 |
| 3.8 MHz | OFF | 1.4 | |
| 3.8 MHz | ONE | 0.61 | |
| 3.8 MHz | TWO | 0.46 | |
| 50.2 MHz | OFF | 1.90 | |
| 50.2 MHz | ONE | 0.78 | |
| 50.2 MHz | TWO | 0.52 | |
| 144.2 MHz | OFF | 0.72 | |
| 144.2 MHz | ONE | 0.43 | |
| 144.2 MHz | TWO | N/A | 2 |
| 120.01 MHz (aircraft) | OFF | 1.1 | |
| 120.01 MHz | ONE | 0.58 | |
| 120.01 MHz | TWO | N/A | 2 |

Notes:

1. Preamp not available at 1 MHz.
2. Only one preamp (108-174 MHz).

FM SINAD and Quieting Test:

Test Description: The purpose of the FM SINAD and Quieting Test is to determine the following at a test frequency of 29.000 MHz:

- 1) The 12 dB SINAD value.

SINAD is an acronym for "Signal plus Noise And Distortion" and is a measure of signal quality. The exact expression for SINAD is the following:

$$\text{SINAD} = \frac{\text{Signal} + \text{Noise} + \text{Distortion}}{\text{Noise} + \text{Distortion}} \quad (\text{expressed in dB})$$

If we consider distortion to be merely another form of noise, (distortion, like noise, is something unwanted added to the signal), we can further reduce the equation for SINAD to:

$$\text{SINAD} = \frac{\text{Signal} + \text{Noise}}{\text{Noise}} \quad (\text{expressed in dB})$$

If we now consider a practical circuit in which the signal is much greater than the noise, the value of the SIGNAL + NOISE can be approximated by the level of the SIGNAL alone. The SINAD equation then becomes the signal to noise ratio. The approximation now becomes:

$$\text{SINAD} = \frac{\text{Signal}}{\text{Noise}} \quad (\text{expressed in dB})$$

For the 25% level of distortion used in this test, the SINAD value can be calculated as follows:

1

$$\text{SINAD} = 20 \log (1/25\%) = 20 \log 4 = 12 \text{ dB}$$

- 2) The level of unmodulated input signal that produces 10 dB of quieting if specified by the manufacturer.
- 3) The level of unmodulated input signal that produces 20 dB of quieting if specified by the manufacturer.

The more negative the number, expressed in dBm, or the smaller the number, expressed as voltage, the better the sensitivity.

Test Results:

| Frequency | Preamplifier | Bandwidth | μV | Notes |
|-----------|--------------|-----------|---------------|-------|
| 29.0 MHz | OFF | 9 kHz | 0.53 | |
| 29.0 MHz | ONE | 9 kHz | 0.21 | |
| 29.0 MHz | TWO | 9 kHz | 0.15 | |
| 29.0 MHz | OFF | 15 kHz | 0.62 | |
| 29.0 MHz | ONE | 15 kHz | 0.25 | |
| 29.0 MHz | TWO | 15 kHz | 0.18 | |
| 52.0 MHz | OFF | 9 kHz | 0.66 | |
| 52.0 MHz | ONE | 9 kHz | 0.26 | |
| 52.0 MHz | TWO | 9 kHz | 0.18 | |
| 52.0 MHz | OFF | 15 kHz | 0.81 | |
| 52.0 MHz | ONE | 15 kHz | 0.30 | |
| 52.0 MHz | TWO | 15 kHz | 0.21 | |
| 146.0 MHz | OFF | 9 kHz | 0.26 | |
| 146.0 MHz | ONE | 9 kHz | 0.17 | |
| 146.0 MHz | TWO | 9 kHz | N/A | |
| 146.0 MHz | OFF | 15 kHz | 0.30 | |
| 146.0 MHz | ONE | 15 kHz | 0.19 | |
| 146.0 MHz | TWO | 15 kHz | N/A | |

Blocking Dynamic Range Test:

Test Description: Dynamic range is a measurement of a receiver's ability to function well on one frequency in the presence of one or more unwanted signals on other frequency. It is essentially a measurement of the difference between a receiver's noise floor and the loudest off-channel signal that can be accommodated without measurable degradation of the receiver's response to a relatively weak signal to which it is tuned. This difference is usually expressed in dB. Thus, a receiver with a dynamic range of 100 dB would be able to tolerate an off-channel signal 100 dB stronger than the receiver's noise floor.

In the case of blocking dynamic range, the degradation criterion is receiver desense. Blocking dynamic range (BDR) is the difference, in dB, between the noise floor and a off-channel signal that causes 1 dB of gain compression in the receiver. It indicates the signal level, above the noise floor, that begins to cause desensitization. BDR is calculated by subtracting the noise floor from the level of undesired signal that produces a 1-dB decrease in a weak desired signal. It is expressed in dB. The greater the dynamic range, expressed in dB, the better the receiver performance. It is usual for the dynamic range to vary with frequency spacing.

Key Test Conditions:

AGC is normally turned off; the receiver is operated in its linear region. Desired signal set to 10 dB below the 1-dB compression point, or 20 dB above the noise floor in receivers whose AGC cannot be disabled. The receiver bandwidth is set as close as possible to 500 Hz.

Block Diagram:

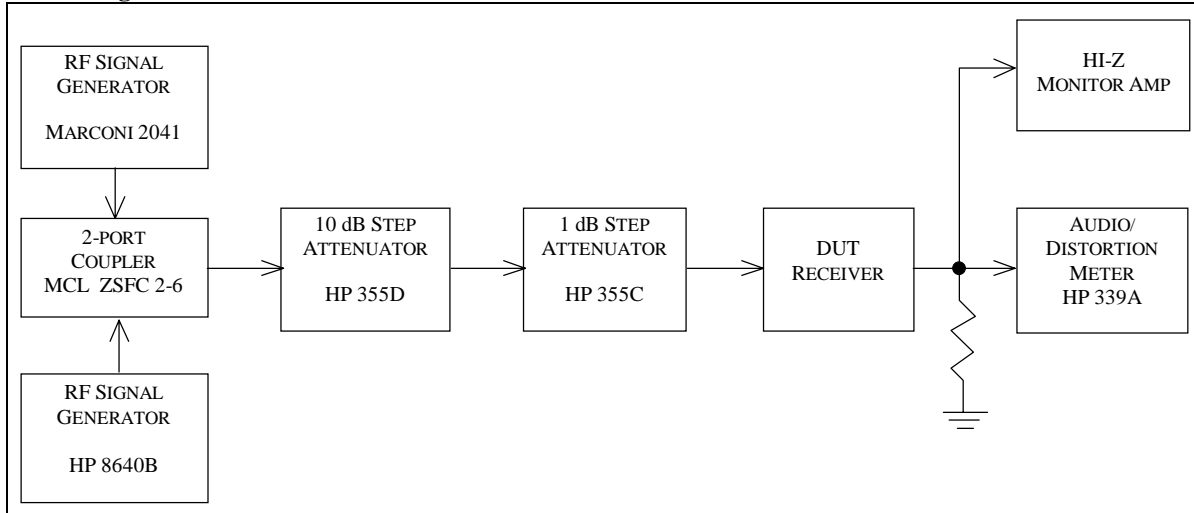

Test Result Summary:

| Band | Preamps | Spacing | BDR (dB) | Notes |
|------------|-----------------|---------|----------|-------|
| 1.82 MHz | ON ¹ | 50 kHz | 125 | 2, 3 |
| 3.52 MHz | OFF | 20 kHz | 123 | |
| 3.52 MHz | ON | 20 kHz | 115 | |
| 3.52 MHz | ON | 50 kHz | 129 | |
| 7.02 MHz | ON | 50 kHz | 128 | |
| 14.02 MHz | OFF | 20 kHz | 122 | |
| 14.02 MHz | ON | 20 kHz | 113 | |
| 14.02 MHz | ON | 50 kHz | 126 | |
| 14.02 MHz | OFF | 100 kHz | 144 | |
| 14.02 MHz | ON | 100 kHz | 126 | |
| 21.02 MHz | ON | 50 kHz | 128 | |
| 28.02 MHz | ON | 50 kHz | 130 | |
| 50.02 MHz | OFF | 20 kHz | 125 | |
| 50.02 MHz | ON | 20 kHz | 116 | |
| 50.02 MHz | ON | 50 kHz | 128 | |
| 144.02 MHz | OFF | 20 kHz | 122* | |
| 144.02 MHz | ON | 20 kHz | 116 | |
| 144.02 MHz | ON | 50 kHz | 128 | |

Notes:

1. ON¹ denotes both preamps on.
 2. 500 Hz receiver bandwidth for all tests.
 3. All dynamic range figures are from the second unit, serial number 001055, as these were more typical of the performance of most IC-746s. The original unit was being repaired by the factory at time this report was being written.
- * Indicates that measurement was noise limited at values shown

Two-Tone 3rd-Order Dynamic Range Test:

Test Description: Intermodulation distortion dynamic range (IMD DR) measures the impact of two-tone IMD on a receiver. IMD is the production of spurious responses resulting from the mixing of desired and undesired signals in a receiver. IMD occurs in any receiver when signals of sufficient magnitude are present. IMD DR is the difference, in dB, between the noise floor and the strength of two equal off-channel signals that produce a third-order product equal to the noise floor. In the case of two-tone, third-order dynamic range, the degradation criterion is a receiver spurious response. If the receiver generates a third-order response equal to the receiver's noise floor to two off-channel signals, the difference between the noise floor and the level of one of the off-channel signals is the blocking dynamic range.

This test determines the range of signals that can be tolerated by the device under test while producing essentially no undesired spurious responses. To perform the 3rd Order test, two signals of equal amplitude and spaced 20 kHz apart, are injected into the input of the receiver. If we call these frequencies f_1 and f_2 , the third-order products will appear at frequencies of $(2f_1-f_2)$ and $(2f_2-f_1)$. The greater the dynamic range, expressed in dB, or the higher the intercept point, the better the performance.

Key Test Conditions:

Sufficient attenuation and isolation must exist between the two signal generators. The two-port coupler must be terminated in a 20-dB return loss load. The receiver is set as close as possible to 500 Hz bandwidth.

Block Diagram:

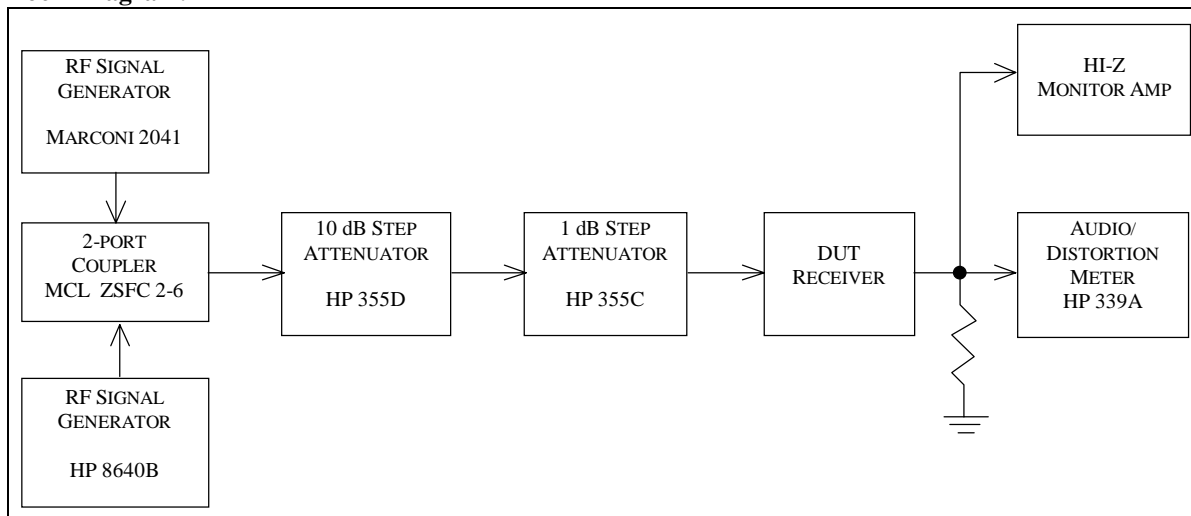

Test Result Summary:

| Band | Spacing | Preamplifier OFF IMD DR (dB) | Preamplifier ON ¹ IMD DR (dB) | Notes |
|------------|---------|---------------------------------|---|-------|
| 1.82 MHz | 50 kHz | N/A | 90 | 2, 3 |
| 3.52 MHz | 20 kHz | 99 | 96 | |
| 3.52 MHz | 50 kHz | N/A | 94 | |
| 7.02 MHz | 50 kHz | N/A | 94 | |
| 14.02 MHz | 20 kHz | 99 | 92 | |
| 14.02 MHz | 50 kHz | N/A | 92 | |
| 14.02 MHz | 100 kHz | 104 | 92 | |
| 21.02 MHz | 50 kHz | N/A | 93 | |
| 28.02 MHz | 50 kHz | N/A | 94 | |
| 50.02 MHz | 20 kHz | 97 | 96 | |
| 50.02 MHz | 50 kHz | N/A | 94 | |
| 144.02 MHz | 20 kHz | 89 | 93 | |
| 144.02 MHz | 50 kHz | N/A | 89 | |

Notes:

1. Both preamps on.
 2. Unit tested at 500 Hz bandwidth.
 3. All dynamic range figures are from the second unit, serial number 001055, as these were more typical of the performance of most IC-746s. The original unit was being repaired by the factory at time this report was being written.
- * Indicates that the measurement was noise limited at values shown.

Dynamic Range Graphs:

The following page shows one of the highlights of ARRL test result reports -- swept graphs on receiver two-tone, third-order IMD dynamic range and blocking dynamic range. These graphs are taken using National Instruments LabWindows CVI automated test software, with a custom program written by the ARRL Laboratory.

Dynamic range measures the difference between a receiver's noise floor and the receiver's degradation in the presence of strong signals. In some cases, the receiver's noise performance causes receiver degradation before blocking or a spurious response is seen. In either case, if the noise floor is degraded by 1 dB due to the presence of receiver noise during the test, the dynamic range is said to be noise limited by the level of signal that caused the receiver noise response. A noise-limited condition is indicated in the *QST* "Product Review" test-result tables. The Laboratory is working on software changes that will show on the test-result graphs which specific frequencies were noise limited. These will be incorporated into future test-result reports.

Being "noise limited" is not necessarily a bad thing. A receiver noise limited at a high level is better than a receiver whose dynamic range is lower than the noise-limited level. In essence, a receiver that is noise limited has a dynamic range that is better than its local-oscillator noise. Most of the best receivers are noise limited at rather high levels.

The ARRL Laboratory has traditionally used off-channel signals spaced 20 kHz from the desired signal. This does allow easy comparisons between different receivers. There is nothing magical about the 20-kHz spacing, however. In nearly all receivers, the dynamic range varies with signal spacing, due to the specific design of the receiver. Most receivers have filter combinations that do some coarse filtering at RF and in the first IF, with additional filtering taking place in later IF or AF stages. As the signals get "inside" different filters in the receiver, the dynamic range decreases as the attenuation of the filter is no longer applied to the signal. Interestingly, the different filter shapes can sometimes be seen in the graphs of dynamic range of different receivers. In the case of the ARRL graphs, one can often see that the 20-kHz spacing falls on the slope of the curve. Many manufacturers specify dynamic range at 50 or 100 kHz.

The computer is not as skilled (yet) at interpreting noisy readings as a good test engineer, so in some cases there are a few dB difference between the computer-generated data and those in the "Product Review" tables. Our test engineer takes those number manually, carefully measuring levels and interpreting noise and other phenomena that can effect the test data. (We are still taking the two-tone IMD data manually.)

The graphs that follow show swept blocking and two-tone dynamic range. In the blocking test, the receiver is tuned to a signal on 14.020 MHz, the center of the graph. The X axis is the frequency (MHz) of the undesired, off-channel signal. In the two-tone test, the receiver is tuned to a signal on 14.020 MHz, the center of the graph. The X axis is the frequency of the closer of the two tones that are creating intermodulation.

Dynamic-Range Graphs:

Swept Blocking Dynamic Range

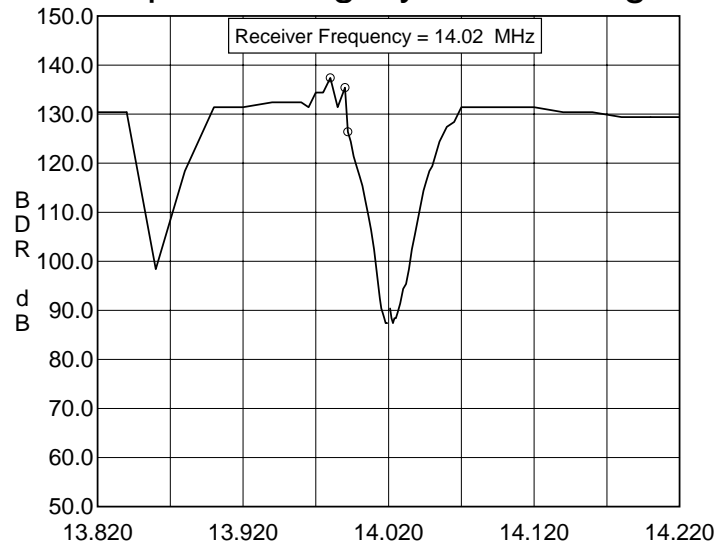

Swept Two-Tone, Third-Order IMD Dynamic Range

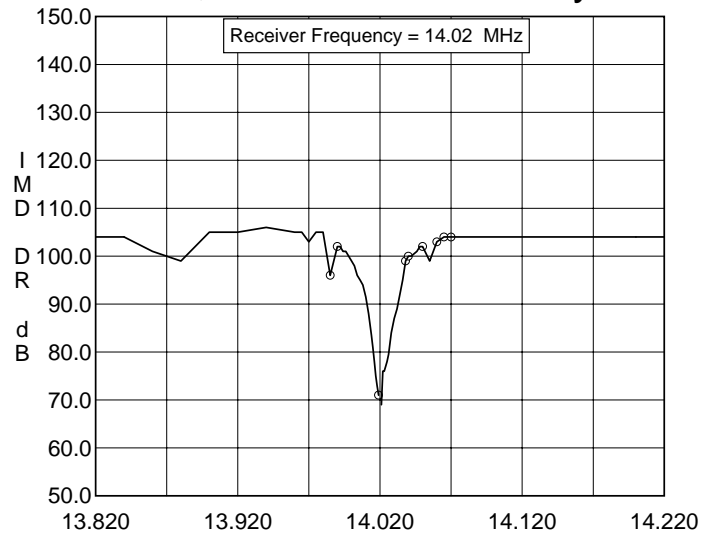

Second-Order IMD Test:

Test Description: This test measures the amount of 2nd-order mixing that takes place in the receiver. Signals at 6 and 8 MHz are presented to the receiver and the resultant output at 14 MHz is measured.

Test Results:

| Frequency | Preamplifier | Mode | IP2 (dBm) | Notes |
|-----------|--------------|------|-----------|-------|
| 14.02 MHz | OFF | CW | +60 | |
| 14.02 MHz | ON | CW | +47 | 1 |

Notes:

1. This figure is the same for both preamps.

In-Band Receiver IMD Test:

Test Description: This test measures the intermodulation that occurs between two signals that are simultaneously present in the passband of a receiver. Two signals, at levels of 50 μ V (nominally S9), spaced 100 Hz are used. The receiver AGC is set to FAST. The receiver is tuned so the two signals appear at 900 Hz and 1100 Hz in the receiver audio. The output of the receiver is viewed on a spectrum analyzer and the 3rd- and 5th order products are measured directly from the screen. The smaller the products as seen on the graph, the better the receiver. Generally, products that are less than 30 dB below the desired tones will not be cause objectionable receiver intermodulation distortion.

Key Test Conditions:

S9 or S9 + 40 dB signals

Receiver set to SSB normal mode, nominal 2 - 3 kHz bandwidth

Block Diagram:

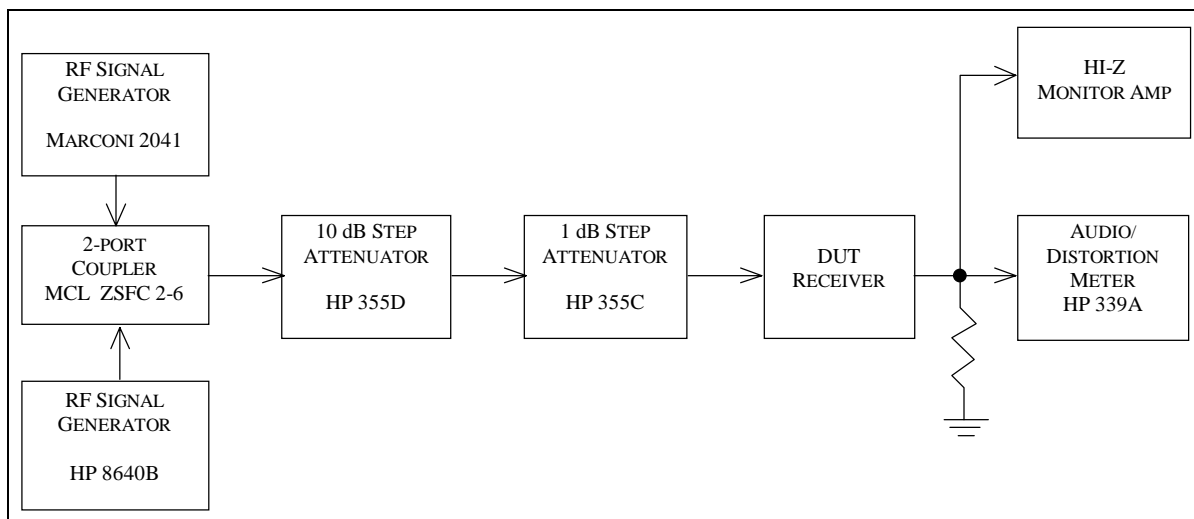

In-Band Receiver IMD Graphs:

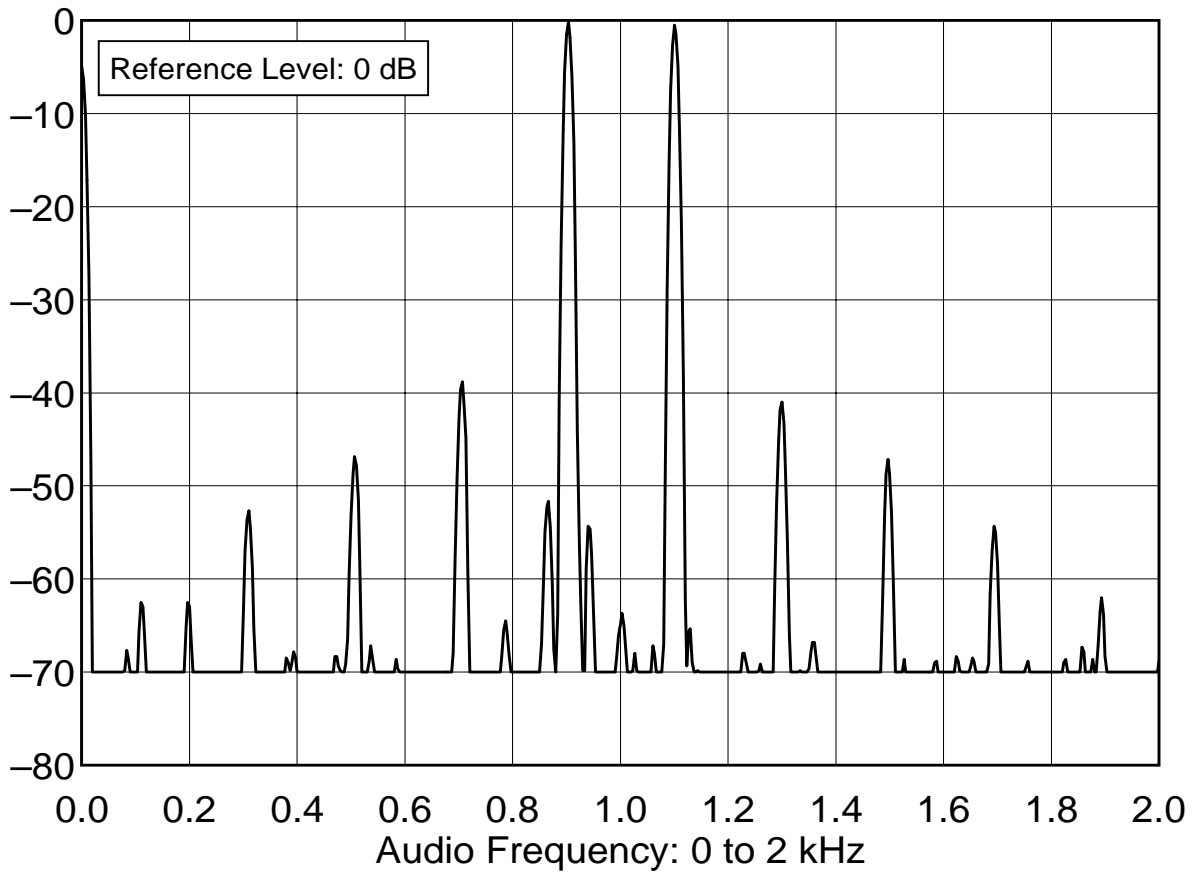

ICOM IC-746 serial number 01055
14.020 MHz, AGC Fast, In-Band Receiver IMD
F:\SHARED\PROD_REV\TESTS\IC746.2ND\IC746IBF.TXT

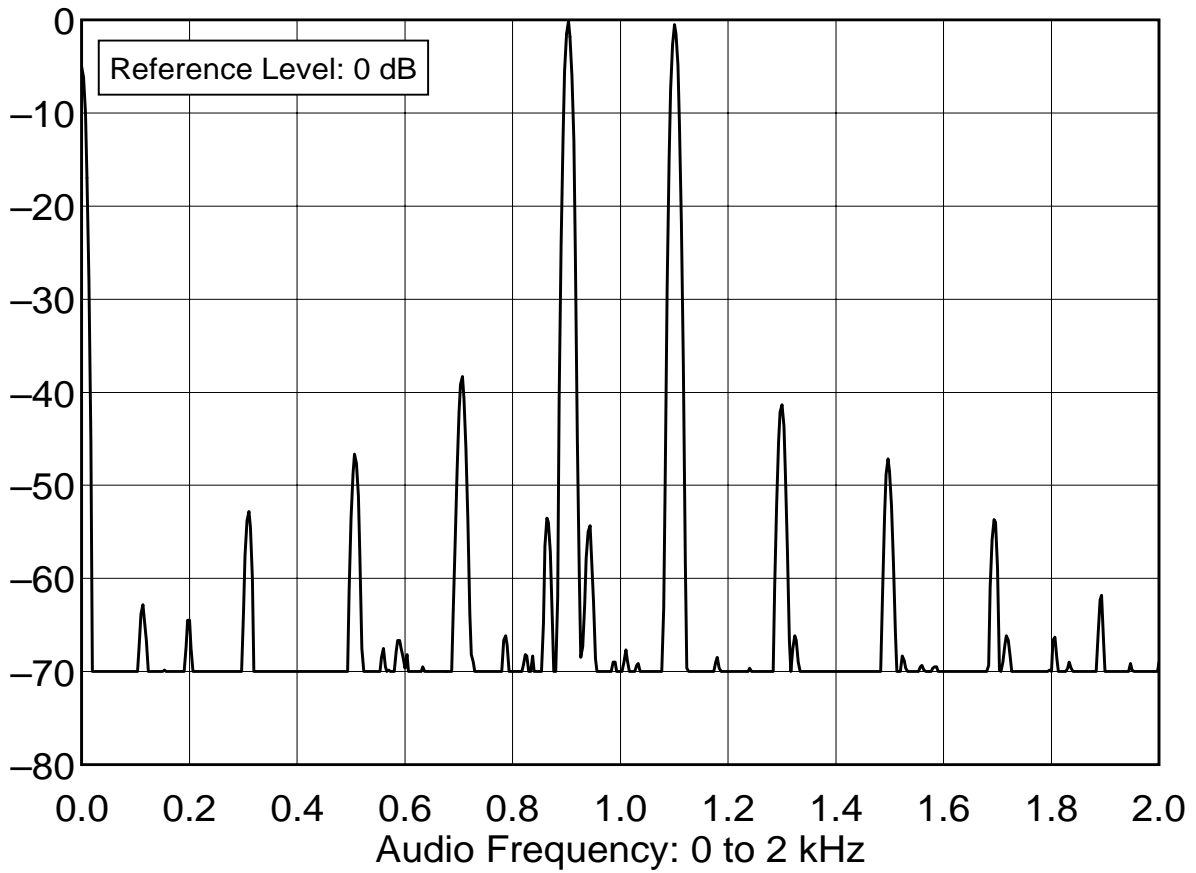

ICOM IC-746 serial number 01055
 14.020 MHz, AGC Slow, In-Band Receiver IMD
 F:\SHARED\PROD_REV\TESTS\IC746.2ND\IC746IBS.TXT

FM Adjacent Channel Selectivity Test:

Test Description: The purpose of the FM Adjacent Channel Selectivity Test is to measure the ability of the device under test receiver to reject interference from individual undesired signals while receiving various levels of desired signal. The desired carrier signal will be at 29.000 MHz, modulated at 1000 Hz, and the offending signal will be located at adjacent nearby frequencies with 400 Hz modulation. (NOTE: The SINAD Test in 5.3 must be performed before this test can be completed.) The greater the number in dB, the better the rejection.

Test Results:

| Frequency | Preamplifier | Frequency Spacing | Adjacent-channel rejection (dB) | Notes |
|-----------|--------------|-------------------|---------------------------------|-------|
| 29.0 MHz | ON | 20 kHz | 60 | |
| 52 MHz | ON | 20 kHz | 72 | |
| 146 MHz | ON | 20 kHz | 71 | |

Notes:

FM Two-Tone 3rd-Order Dynamic Range Test:

Test Description: The purpose of the FM Two-Tone 3rd Order Dynamic Range Test is to determine the range of signals that can be tolerated by the device under testing the FM mode while producing no spurious responses greater than the 12-dB SINAD level. To perform this test, two signals, f_1 and f_2 , of equal amplitude and spaced 20 kHz apart, are injected into the input of the receiver. The signal located 40 kHz from the distortion product being measured is modulated at 1,000 Hz with a deviation of 3 kHz. The receiver is tuned to the Third Order IMD frequencies as determined by $(2f_1-f_2)$ and $(2f_2-f_1)$. The input signals are then raised simultaneously by equal amounts until 25 % distortion, or the 12 dB SINAD point, is obtained. Frequencies 10 MHz outside the amateur band are used to test the wide-band dynamic range. The greater the dynamic range, the better the receiver performance.

Test Results:

| Frequency | Preamplifier | Frequency Spacing | Dynamic Range (dB) | Notes |
|-----------|--------------|-------------------|--------------------|-------|
| 29 MHz | ON | 20 kHz | 64* | 1, 2 |
| 52 MHz | ON | 20 kHz | 72* | |
| 52 MHz | ON | 10 MHz | -- | 3 |
| 146 MHz | ON | 20 kHz | 71* | |
| 146 MHz | ON | 10 MHz | 82 | |

Notes:

1. FM Narrow for all tests in this table.
2. All FM dynamic range data is from the second unit, serial number 001055.
3. A third-order product could not be obtained at 10 MHz tone spacings on 52 MHz. This is most likely due to the lack of receive coverage between 60 and 108 MHz (the tones used are 62 and 72 MHz).

* Test is noise limited. In FM, this results in a reading that is somewhat inaccurate. The actual dynamic range is probably a few dB worse than the figures indicated. While this sounds opposite of what one would expect, because the test is based on a SINAD measurement, the presence of noise means that it takes a stronger signal to have a product equal to the measured noise floor, resulting in a number that appears better than it would be if there were no noise.

Image Rejection Test:

Test Description: This test measures the amount of image rejection for superhetrodyne receivers by determining the level of signal input to the receiver at the first IF image frequencies that will produce an audio output equal to the MDS level. The test is conducted with the receiver in the CW mode using the 500 Hz, or closest available, IF filters. Any audio filtering is disabled and AGC is turned OFF, if possible. The test is performed with the receiver tuned to 14.020 MHz for receivers that have 20-meter capability, or to a frequency 20 kHz up from the lower band edge for single-band receivers. The greater the number in dB, the better the image rejection.

Test Results:

| Frequency | Preamplifier | Mode | Calculated Image Frequency | Image Rejection (dB) | Notes |
|------------|--------------|------|----------------------------|----------------------|-------|
| 14.250 MHz | OFF | CW | 152.27 MHz | 120 | |
| 50.2 MHz | OFF | CW | 188.27 MHz | 117 | |
| 144.2 MHz | OFF | CW | 282.27 MHz | 90 | |

Notes:

IF Rejection Test:

Test Description: This test measures the amount of first IF rejection for superhetrodyne receivers by determining the level of signal input to the receiver at the first IF that will produce an audio output equal to the MDS level. The test is conducted with the receiver in the CW mode using the 500 Hz, or closest available, IF filters. Any audio filtering is disabled and AGC is turned OFF, if possible. The test is performed with the receiver tuned to 14.020 MHz for receivers that have 20-meter capability, or to a frequency 20 kHz up from the lower band edge for single-band receivers. The greater the number in dB, the better the IF rejection.

Test Results:

| Frequency | Preamplifier | Mode | 1st IF Rejection | Notes |
|------------|--------------|------|------------------|-------|
| 14.250 MHz | OFF | CW | 100 dB | |
| 50.2 MHz | OFF | CW | 75 | |
| 144.2 MHz | OFF | CW | 72 | |

Notes:

Audio Output Power Test:

Test Description: This test measures the audio power delivered by the receiver. The manufacturer's specification for load and distortion are used. For units not specified, an 8-ohm load and 10% harmonic distortion are used.

Test Results:

| Specified Distortion | Specified Load Impedance | Audio Output Power | Notes |
|----------------------|--------------------------|--------------------|-------|
| 10% T.H.D. | 8 ohms | 2.3 W | |

Notes:

IF + Audio Frequency Response Test:

Test Description: The purpose of the IF + Audio Frequency Response Test is to measure the audio frequencies at which the receiver audio drops 6 dB from the peak signal response. The frequency-response bandwidth is then calculated by taking the difference between the lower and upper frequency.

Test Results:

| IF Filter Use/Unit Mode | Nominal Bandwidth Hz | Low Freq (Hz) | High Freq (Hz) | Difference (bandwidth) | Notes |
|-------------------------|----------------------|---------------|----------------|------------------------|-------|
| CW | 500 | 320 | 848 | 528 | |
| CW | WIDE | 284 | 2589 | 2300 | |
| USB | WIDE | 297 | 2549 | 2252 | |
| LSB | WIDE | 283 | 2587 | 2304 | |
| AM | NARROW | 83 | 28898 | 2806 | |

Squelch Sensitivity Test:

Test Description: The purpose of the Squelch Sensitivity Test is to determine the level of the input signal required to break squelch at the threshold and at the point of maximum squelch. This number is not usually critical. A result anywhere between 0.05 and 0.5 μV is usually useful. The maximum can range to infinity.

Test Results:

| Frequency | Preamplifier | Mode | Minimum μV | Notes |
|-----------|--------------|------|-----------------------|-------|
| 29.0 MHz | One and Two | FM | 0.07 | |
| 52 MHz | One and Two | FM | 0.07 | |
| 146 MHz | One and Two | FM | 0.06 | |
| 14.2 MHz | One and Two | SSB | N/A | 1 |

Notes:

1. The SSB squelch on the original unit did not function properly.

S-Meter Test:

Test Description: The purpose of the S-Meter Test is to determine the level of RF input signal required to produce an S9 and S9+20 dB indication on the receiver S meter. This test is performed with the receiver in the CW mode at a frequency of 14.200 MHz. The IF filter is set to 500 Hz, nominal. A traditional S9 signal is a level of 50 μV (an old Collins receiver standard). The Collins standard S unit was 6 dB. This is, however, not a hard and fast rule, especially for LED or bar-graph type S meters.

Test Results:

| Frequency | Preamplifier | S Units | μV | Notes |
|-----------|--------------|---------|---------------|-------|
| 1.02 MHz | OFF | S9 | 243 | |
| 14.2 MHz | OFF | S9 | 77.6 | |
| 14.2 MHz | ONE | S9 | 23.7 | |
| 14.2 MHz | TWO | S9 | 7.0 | |
| 52 MHz | OFF | S9 | 143 | |
| 52 MHz | ONE | S9 | 27.9 | |
| 52 MHz | TWO | S9 | 13.8 | |
| 146 MHz | OFF | S9 | 32.0 | |
| 146 MHz | ON | S9 | 10.1 | |