



**VT82C597
VT82C597AT**

Apollo VP3

**Single-Chip North Bridge
for Pentium / Socket-7
with AGP and PCI
plus Advanced ECC Memory Controller
supporting DDR SDRAM-II,
SDRAM, EDO, and FPG**

Revision 1.0
October 3, 1997

VIA TECHNOLOGIES, INC.

Copyright Notice:

Copyright © 1997 VIA Technologies Incorporated. Printed in the United States. ALL RIGHTS RESERVED.

No part of this document may be reproduced, transmitted, transcribed, stored in a retrieval system, or translated into any language, in any form or by any means, electronic, mechanical, magnetic, optical, chemical, manual or otherwise without the prior written permission of VIA Technologies Incorporated.

VT82C597, VT82C586B, and Apollo VP3 may only be used to identify products of VIA Technologies.

PS/2™ is a registered trademark of International Business Machines Corp.

Pentium™, P54C™, P55C™, and MMX™ are registered trademarks of Intel Corp.

Cyrix6x86™ is a registered trademark of Cyrix Corp.

AMD5_K86™, AMD6_K86™, AMD-K5™, and AMD-K6™ are registered trademarks of Advanced Micro Devices Corp.

Windows 95™ and Plug and Play™ are registered trademarks of Microsoft Corp.

PCI™ is a registered trademark of the PCI Special Interest Group.

VESA™ is a trademark of the Video Electronics Standards Association.

All trademarks are the properties of their respective owners.

Disclaimer Notice:

No license is granted, implied or otherwise, under any patent or patent rights of VIA Technologies. VIA Technologies makes no warranties, implied or otherwise, in regard to this document and to the products described in this document. The information provided by this document is believed to be accurate and reliable to the publication date of this document. However, VIA Technologies assumes no responsibility for any errors in this document. Furthermore, VIA Technologies assumes no responsibility for the use or misuse of the information in this document and for any patent infringements that may arise from the use of this document. The information and product specifications within this document are subject to change at any time, without notice and without obligation to notify any person of such change.

Offices:

USA Office:

1045 Mission Court

Fremont, CA 94539

USA

Tel: (510) 683-3300

Fax: (510) 683-3301

Taipei Office:

8th Floor, No. 533

Chung-Cheng Road, Hsin-Tien

Taipei, Taiwan ROC

Tel: (886-2) 218-5452

Fax: (886-2) 218-5453

Online Services:

Home Page: <http://www.via.com.tw> (Taiwan) -or- <http://www.viatech.com> (USA)

FTP Server: <ftp.via.com.tw> (Taiwan)

BBS: 886-2-2185208

REVISION HISTORY

Document Release	Date	Revision	Initials
0.1	3/28/97	Original release (VIA internal review only)	DH
0.2	4/1/97	Changed memory technologies supported to FP,EDO,SDRAM,SDRAM-II Fixed Introduction and Feature bullets per engineering review Rearranged registers to clarify that registers 50-8F are device 0 Added pin descriptions for DS[3:0], GGNT#, and clocks Fixed miscellaneous register bit descriptions per engineering review	DH
0.3	4/29/97	Added 456-pin BGA Mechanical Specification drawing Rearranged pin groupings and changed pinouts per PCB floorplanning Updated register definitions to reflect internal spec Rev 0.5 (4/15/97)	DH
0.4	5/14/97	Updated pinouts to reflect final pinout after chip layout / pad placement Updated Feature Bullets and Overview to reflect final chip design Updated pin descriptions per engineering input and final chip design Updated register descriptions per engineering input and final chip design	DH
0.5	5/15/97	Updated pinouts (MD, MPD, & CAS pin swaps). Per 5/15/97 engg spec Added pin descriptions for GVREF, MVREF, AVCC, AGND	DH
0.6	5/21/97	Changed package from 456-pin to 472-pin BGA - updated mechanical spec Updated pinouts: added 16 grounds in package center Updated pinouts: changed 4 GND pins to CVCC (supply for internal logic) Updated pinouts: changed 2 HVCC pins to MVCC Updated pin descriptions for clock pins	DH
0.7	6/16/97	Removed "NDA Required" watermark (product announced at Computex) Moved ground balls from M9-M10 to N9-N10 (fixed pinouts and mechanical) Added central-DQ support (feature bullets and register bits) Fixed typos (block diagram BGA ball count, and alpha pin list J18)	DH
0.8	9/22/97	Fixed feature bullets in AGP and memory controller sections Fixed Pinouts & Pin Definitions: 597 pinout error: CAS1 swapped with CAS2; CAS5 swapped with CAS6 Added 82C597AT pinouts Updated pin definitions and signal names (SBS#, ADS0-1#) Removed COE2# and CCS2# functionality from TA8-9 (not implemented) Added MWEA# and MWEB# function on SWEA# and SWEB# Added AGP PCB layout notes Changed AGP clock (GCLK) to grounded input (generated internally) Fixed Register Descriptions: Added Chip Revision info to Device 0 Rx08 Fixed typos in Device 0 Rx10, Rx58, and RxAC Updated bit definitions in Device 0 Rx64, 68, 6C, 70, 71, 76, 80, 88, and AC Added Device 0 Rx6B DRAM Arbitration Control Added Device 0 Rx74 PCI Master Control 2 Added Device 0 Rx77 Chip Test, Rx7E DLL/DLL4 Test, Rx7F DLL4 Test Added Device 1 Rx3E PCI-to-PCI Bridge Control Updated bit definitions in Device 1 Rx40 and 42 Added Electrical Specifications & Timing Diagrams	DH
1.0	10/3/97	Timing Diagrams redrawn to reduce final PDF file size Timing Specification AC Timing numbers rounded to one decimal place Timing Specification AC Timing Table 8 numbers updated Changed name of ADS[1-0]# to GDS[1-0]# reduce confusion with ADS# Added new VIA logos and removed "Preliminary" from document revision	DH

TABLE OF CONTENTS

REVISION HISTORY	I
TABLE OF CONTENTS	II
LIST OF FIGURES	III
LIST OF TABLES	IV
OVERVIEW	4
PINOUTS	5
PINOUTS	8
REGISTERS	19
REGISTER OVERVIEW	19
CONFIGURATION SPACE I/O	20
REGISTER DESCRIPTIONS	21
Device 0 Header Registers - Host Bridge	21
Device 0 Configuration Registers - Host Bridge	23
Cache Control	23
DRAM Control	25
PCI Bus #1 Control.....	30
GART / Graphics Aperture Control	33
AGP Control	35
Device 1 Header Registers - PCI-to-PCI Bridge	36
Device 1 Configuration Registers - PCI-to-PCI Bridge	38
PCI Bus #2 Control.....	38
ELECTRICAL SPECIFICATIONS	39
ABSOLUTE MAXIMUM RATINGS	39
DC CHARACTERISTICS	39
AC TIMING SPECIFICATIONS	39
MECHANICAL SPECIFICATIONS	74

LIST OF FIGURES

FIGURE 1. APOLLO VP3 SYSTEM BLOCK DIAGRAM.....	4
FIGURE 2. VT82C597 BALL DIAGRAM (TOP VIEW).....	5
FIGURE 3. VT82C597 PIN LIST (NUMERICAL ORDER)	6
FIGURE 4. VT82C597 PIN LIST (ALPHABETICAL ORDER).....	7
FIGURE 5. VT82C597AT BALL DIAGRAM (TOP VIEW)	8
FIGURE 6. VT82C597AT PIN LIST (NUMERICAL ORDER).....	9
FIGURE 7. VT82C597AT PIN LIST (ALPHABETICAL ORDER).....	10
FIGURE 8. GRAPHICS APERTURE ADDRESS TRANSLATION	33
FIGURE 6. AGP MEMORY ACCESS (LPR).....	45
FIGURE 7. 2-BANK PBSRAM READ 3111-2111	46
FIGURE 8. PCI-66 CONFIGURATION CYCLE.....	47
FIGURE 9. AGP READ SDRAM (2L) 1X PIPE MODE.....	48
FIGURE 10. AGP READ EDO 1X PIPE MODE.....	49
FIGURE 11. AGP READ EDO PIPE 2X MODE.....	50
FIGURE 12. AGP SIDEBAND ADDRESS 2X WRITE SDRAM.....	51
FIGURE 13. AGP SIDEBAND ADDRESS 2X READ SDRAM (2L)	52
FIGURE 14. AGP SIDEBAND ADDRESS 1X READ SDRAM (2L)	53
FIGURE 15. AGP SIDEBAND ADDRESS 1X WRITE SDRAM	54
FIGURE 16. POST WRITE 3111, EDO DRAM 2222	55
FIGURE 17. PIPELINE READ EDO DRAM 6222, 3222	56
FIGURE 18. CPU WRITE HIT SRAM 3111.....	57
FIGURE 19. CPU READ HIT SRAM 3111	58
FIGURE 20. CPU READ MISS FILL SYNCHRONOUS SRAM	59
FIGURE 21. CPU WRITE PCI SLAVE WRITE BUFFER ON FAST BACK-TO-BACK.....	60
FIGURE 22. CPU READ PCI SLAVE.....	61
FIGURE 23. PCI MASTER READ L1 SNOOP TO DRAM.....	62
FIGURE 24. PCI MASTER READ HIT L2	63
FIGURE 25. PCI MASTER READ L1 SNOOP TO L2.....	64
FIGURE 26. SDRAM READ CYCLE (BANK INTERLEAVE, CAS LATENCY 3)	65
FIGURE 27. SDRAM WRITE CYCLE (BANK INTERLEAVE)	66
FIGURE 28. PCI MASTER READ HIT DRAM.....	67
FIGURE 29. PCI MASTER WRITE DRAM	68
FIGURE 30. PCI MASTER WRITE HIT L1 SNOOP TO DRAM	69
FIGURE 31. PCI MASTER WRITE HIT L2	70
FIGURE 32. PCI MASTER WRITE HIT L2, L1 HITM	71
FIGURE 33. PCI MASTER WRITE HIT L2 & DIRTY	72
FIGURE 34. CPU READ MISS DIRTY L2 WRITE BACK FILL.....	73
FIGURE 39. MECHANICAL SPECIFICATIONS - 472-PIN BALL GRID ARRAY PACKAGE	74

LIST OF TABLES

TABLE 1. VT82C597 / VT82C597AT PIN DESCRIPTIONS	11
TABLE 2. VT82C597 REGISTERS	19
TABLE 3. COAST MODULE DETECTION	23
TABLE 4. SYSTEM MEMORY MAP	25
TABLE 5. MEMORY ADDRESS MAPPING TABLE	25
TABLE 6. VGA/MDA MEMORY/IO REDIRECTION	38
TABLE 7. AC TIMING MIN / MAX CONDITIONS	39
TABLE 8. AC CHARACTERISTICS - CPU CYCLE TIMING	40
TABLE 9. AC CHARACTERISTICS - L2 CACHE TIMING	40
TABLE 10. AC CHARACTERISTICS - DRAM INTERFACE TIMING	41
TABLE 11. AC CHARACTERISTICS - DATA TIMING	41
TABLE 12. AC CHARACTERISTICS - PCI CYCLE TIMING	42
TABLE 13. AC CHARACTERISTICS - PCI-66 CYCLE TIMING	43
TABLE 14. AC CHARACTERISTICS - AGP (1X) CYCLE TIMING	44
TABLE 15. AC CHARACTERISTICS - AGP (2X) CYCLE TIMING	44

VIA VT82C597/597AT APOLLO VP3
Single-Chip North Bridge
for Pentium / Socket-7
with AGP and PCI
plus Advanced ECC Memory Controller
supporting DDR SDRAM-II,
SDRAM, EDO, and FPG

- **PCI/ISA Green PC Ready**

- Supports separately powered 3.3V (5V tolerant) interfaces to system memory, AGP, and PCI bus
- Supports 3.3V and sub-3.3V interface to CPU
- PC-97 compatible using VT82C586B South Bridge with ACPI Power Management

- **High Integration**

- Single chip implementation for 64-bit Socket-7-CPU, 64-bit system memory, 32-bit PCI and 32-bit AGP interfaces
- **Apollo VP3** Chipset: **VT82C597 or VT82C597AT** system controller and **VT82C586B** PCI to ISA bridge
- Chipset includes UltraDMA-33 EIDE, USB, and Keyboard / PS2-Mouse Interfaces plus RTC / CMOS on chip

- **Flexible CPU Interface**

- Supports 64-bit Pentium™, AMD 5_K86™, AMD 6_K86™ and Cyrix 6_X86™ CPUs
- CPU external bus speed up to 66 MHz (internal 233MHz and above)
- Supports CPU internal write-back cache
- System management interrupt, memory remap and STPCLK mechanism
- Cyrix 6_X86 linear burst support
- CPU NA# / Address pipeline capability
- 4 cache lines of CPU/cache-to-DRAM post-write buffers
- 4 quadwords of CPU/cache-to-DRAM read-prefetch buffers

- **Advanced Cache Controller**

- Direct map write back or write through secondary cache
- Pipelined burst synchronous SRAM (PBSRAM) cache support (with global write enable feature)
- Flexible cache size: 0K / 256K / 512K / 1M / 2MB
- 32 byte line size to match the primary cache
- Integrated 10-bit tag comparator
- 3-1-1-1 read/write timing for PBSRAM access at 66 MHz
- 3-1-1-1-1-1-1-1 back to back read timing for PBSRAM access at 66 MHz
- Sustained 3 cycle write access for PBSRAM access or CPU to DRAM and PCI bus post write buffers at 66 MHz
- Data streaming for simultaneous primary and secondary cache line fill
- System and video BIOS cacheable and write-protect
- Programmable cacheable region and cache timing

• AGP Controller

- AGP v1.0 compliant
- Supports SideBand Addressing (SBA) mode (non-multiplexed address / data)
- Supports 133MHz 2X mode for AD and SBA signalling
- Pipelined split-transaction long-burst transfers up to 533 MB/sec
- Eight level read request queue
- Four level posted-write request queue
- Thirty-two level (quadwords) read data FIFO (128 bytes)
- Sixteen level (quadwords) write data FIFO (64 bytes)
- Intelligent request reordering for maximum AGP bus utilization
- Supports Flush/Fence commands

• GART

- One level TLB structure
- Sixteen entry fully associative page table
- LRU replacement scheme
- Independent GART lookup control for host / AGP / PCI master accesses

• Intelligent PCI Bus Controller

- PCI buses are synchronous to host CPU bus
- 33 MHz operation on the primary PCI bus
- 66 MHz PCI operation on the AGP bus
- PCI-to-PCI bridge configuration on the 66MHz PCI bus
- Separate data buffers for the two PCI buses
- Peer concurrency
- Concurrent multiple PCI master transactions; i.e., allow PCI masters from both PCI buses active at the same time
- Allows PCI master access while ISA master/DMA is active
- PCI master snoop ahead and snoop filtering
- Five levels (double-words) of CPU to PCI posted write buffers
- Byte merging in the write buffers to reduce the number of PCI cycles and to create further PCI bursting possibilities
- Zero wait state PCI master and slave burst transfer rate
- PCI to system memory data streaming up to 132Mbyte/sec
- Enhanced PCI command optimization (MRL, MRM, MWI, etc.)
- Forty-eight levels (double-words) of post write buffers from PCI masters to DRAM
- Sixteen levels (double-words) of prefetch buffers from DRAM for access by PCI masters
- Supports L1/L2 write-back forward to PCI master read to minimize PCI read latency
- Supports L1/L2 write-back merged with PCI master post-write to minimize DRAM utilization
- Transaction timer for fair arbitration between PCI masters (granularity of two PCI clocks)
- Symmetric arbitration between Host/PCI bus for optimized system performance
- Complete steerable PCI interrupts
- PCI-2.1 compliant, 32 bit 3.3V PCI interface with 5V tolerant inputs

- **Advanced High-Performance DRAM Controller**

- 66MHz DRAM interface
- Concurrent CPU and AGP access
- FP, EDO, SDRAM, and SDRAM-II
- 66MHz DDR (Double Data Rate) supported for SDRAM-II (supports central and edge DQ, bidirectional DS, and optional SDR write)
- Different DRAM types may be used in mixed combinations
- Different DRAM timing for each bank
- Mixed 1M / 2M / 4M / 8M / 16MxN DRAMs
- 6 banks up to 1GB DRAMs
- Flexible row and column addresses
- 64-bit data width only
- 3.3V DRAM interface with 5V-tolerant inputs
- Optional bank-by-bank ECC (single-bit error correction and multi-bit error detection) or EC (error checking only) for DRAM integrity
- Two-bank interleaving for 16Mbit SDRAM support
- Two-bank and four bank interleaving for 64Mbit SDRAM support (14 MA lines)
- Supports maximum 8-bank interleave (i.e., 8 pages open simultaneously); banks are allocated based on LRU
- Seamless DRAM command scheduling for maximum DRAM bus utilization (e.g., precharge other banks while accessing the current bank)
- Four cache lines (16 quadwords) of CPU/cache to DRAM write buffers
- Concurrent DRAM writeback
- Read around write capability for non-stalled CPU read
- Burst read and write operation
- 5-2-2-2 on page, 8-2-2-2 start page and 11-2-2-2 off page timing for EDO DRAMs at 66 MHz
- 6-1-1-1 on page, 8-1-1-1 start page and 10-1-1-1 off page for SDRAMs at 66 MHz
- 5-2-2-2-3-2-2-2 back-to-back accesses for EDO DRAM at 66 MHz
- 6-1-1-1-3-1-1-1 back-to-back accesses for SDRAM at 66 MHz
- BIOS shadow at 16KB increment
- Decoupled and burst DRAM refresh with staggered RAS timing
- Programmable refresh rate, CAS-before-RAS refresh and refresh on populated banks only

- **Built-in NAND-tree pin scan test capability**

- **3.3V, 0.5um, high speed / low power CMOS process**

- **472 pin BGA Package**

- **Alternate pinouts available to optimally accommodate different PCB form factors**

- VT82C597 for ATX and NLX
- VT82C597AT for Baby AT and ATX

OVERVIEW

The *Apollo-VP3* is a high performance, cost-effective and energy efficient chip set for the implementation of AGP / PCI / ISA desktop and notebook personal computer systems based on 64-bit Socket-7 (Intel Pentium and Pentium MMX; AMD K5 / 5_x86 and K6 / 6_x86; and Cyrix / IBM 6_x86 / M2) super-scalar processors.

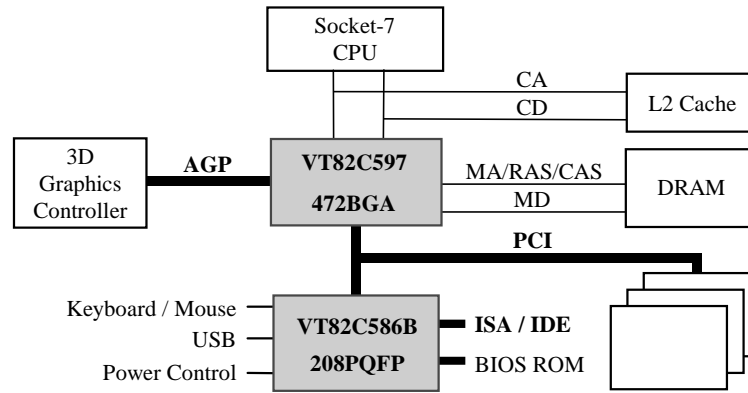

Figure 1. Apollo VP3 System Block Diagram

The Apollo-VP3 chip set consists of the VT82C597 system controller (472 pin BGA) and the VT82C586B PCI to ISA bridge (208 pin PQFP). The VT82C597 system controller provides superior performance between the CPU, optional synchronous cache, DRAM, AGP bus, and PCI bus with pipelined, burst, and concurrent operation. For pipelined burst synchronous SRAMs, 3-1-1-1-1-1-1-1 timing can be achieved for both read and write transactions at 66 MHz. Four cache lines (16 quadwords) of CPU/cache to DRAM write buffers with concurrent write-back capability are included on chip to speed up cache read and write miss cycles.

The VT82C597 supports six banks of DRAMs up to 1GB. The DRAM controller supports standard Fast Page Mode (FPM) DRAM, EDO-DRAM, Synchronous DRAM (SDRAM), and SDRAM-II with Double Data Rate (DDR) in a flexible mix / match manner. The Synchronous DRAM interface allows zero wait state bursting between the DRAM and the data buffers at 66Mhz. The six banks of DRAM can be composed of an arbitrary mixture of 1M / 2M / 4M / 8M / 16MxN DRAMs. The DRAM controller also supports optional ECC (single-bit error correction and multi-bit detection) or EC (error checking) capability separately selectable on a bank-by-bank basis.

The VT82C597 also supports full AGP v1.0 capability for maximum bus utilization including 2x mode transfers, SBA (SideBand Addressing), Flush/Fence commands, and pipelined grants. An eight level request queue plus a four level post-write request queue with thirty-two and sixteen quadwords of read and write data FIFO's respectively are included for deep pipelined and split AGP transactions. A single-level GART TLB with 16 full associative entries and flexible CPU/AGP/PCI remapping control is also provided for operation under protected mode operating environments.

The VT82C597 supports two 32-bit 3.3 / 5V system buses (one AGP and one PCI) with 64-bit to 32-bit data conversion. The 82C597 also contains a built-in bus-to-bus bridge to allow simultaneous concurrent operations on each bus. Five levels (doublewords) of post write buffers are included to allow for concurrent CPU and PCI operation. Consecutive CPU addresses are converted into burst PCI cycles with byte merging capability for optimal CPU to PCI throughput. For PCI master operation, forty-eight levels (doublewords) of post write buffers and sixteen levels (doublewords) of prefetch buffers are included for concurrent PCI bus and DRAM/cache accesses. The chipset also supports enhanced PCI bus commands such as Memory-Read-Line, Memory-Read-Multiple and Memory-Write-Invalid commands to minimize snoop overhead. In addition, the chipset supports advanced features such as snoop ahead, snoop filtering, L1 write-back forward to PCI master and L1 write-back merged with PCI post write buffers to minimize PCI master read latency and DRAM utilization. The VT82C586B PCI to ISA bridge supports four levels (doublewords) of line buffers, type F DMA transfers and delay transaction to allow efficient PCI bus utilization and (PCI-2.1 compliant). The VT82C586B also includes an integrated keyboard controller with PS2 mouse support, integrated DS12885 style real time clock with extended 256 byte CMOS RAM, integrated master mode enhanced IDE controller with full scatter and gather capability and extension to UltraDMA-33 / ATA-33 for 33MB/sec transfer rate, integrated USB interface with root hub and two function ports with built-in physical layer transceivers, Distributed DMA support, and OnNow / ACPI compliant advanced configuration and power management interface. A complete main board can be implemented with only six TTLs.

The Apollo VP3 chipset is ideal for high performance, high quality, high energy efficient and high integration desktop and notebook AGP / PCI / ISA computer systems.

PINOUTS

Figure 2. VT82C597 Ball Diagram (Top View)

Key	1	2	3	4	5	6	7	8	9	10	11	12	13	14	15	16	17	18	19	20	21	22	23	24	25	26	
A	MD58	MD27	MD28	MD61	MD63	GD1	GD7	GBE0#	GD11	GBE1#	GTRDY#	GD17	GD20	GD25	GD28	GD31	SBA5	SBA1	ST0	GREQ#	GPAR	STOP#	AD17	AD21	AD22	AD23	
B	MD57	MD26	MD59	MD29	MD31	GD0	GD4	GDS0#	GD12	GD15	GDSSEL#	GFRM#	GD19	GBE3#	GD26	GD29	SBA4	SBA3	GPIPE#	ST1	GGNT#	LOCK#	AD16	AD19	AD20	CBE3#	
C	MD24	MD56	MD25	MD60	MD62	GD5	GD2	GD6	GD9	GD13	GSTOP	GIRDY	GD18	GD22	GD24	GD30	SBA7	SBS#	GRBF#	GSERR#	-res-	SERR#	CBE2#	AD18	AD24	AD25	
D	MD22	MD54	MD23	MD55	MD30	GD8	GD3	GND	GD10	GD14	GBE2#	GD21	GD23	GDS1#	GD27	SBA6	SBA2	SBA0	PCLK	PAR	ST2	AD0	AD1	AD27	AD26	AD28	
E	MD52	MD21	MD53	DS3#	CVCC	GND	GND	GCLK	GVCC	GVCC	GVCC	GD16	GVRE	GND	GND	GND	GVCC	GVCC	GVCC	-res-	5VREF	GND	AD2	AD29	AD30	AD31	
F	MD19	MD51	MD20	DS1#	AVCC	F6	7	8	9	10	11	12	13	14	15	16	17	18	19	20	F21	CVCC	AD3	REQ0#	GNT0#	REQ1#	
G	MD49	MD18	MD50	MD17	MVCC	G	Data	Total = 472 Pins					AGP Pins					G	AD5	AD4	GNT1#	REQ2#	GNT2#				
H	SWEC#	MD16	MD48	MPD7	MVCC	H		9	10	11	12	13	14	15	16	17	18	PCI Pins			H	AD6	AD7	REQ3#	GNT3#	AD14	
J	CAS7#	SWEA#	SWEB#	MPD3	MVCC	J	J	GND		GND		GND		GND		J	PCI Pins			J	PVCC	AD8	AD15	CBE1#	DSEL#		
K	CAS1#	CAS5#	CAS3#	MPD2	AGND	K	Control	K	GND		11	12	13	GND		15	16	GND		K	K	PVCC	CBE0#	AD9	TRDY#	IRDY#	
L	RAS3#	RAS1#	RAS0#	MPD6	GND	L		L	GND		GND		GND		GND		GND		L	L	PVCC	AD10	AD12	FRM#	PGNT#		
M	MAA1	RAS5#	RAS4#	RAS2#	GND	M	Mem Pins	M	GND		GND		GND		GND		GND		M	M	Cache	AD11	AD13	PREQ#	RESET#	TA2	
N	MA12	MA13	MAA0	MA8	HCLK	N		N	GND		GND		GND		GND		GND		N	N	Cache	TA5	TA4	TA3	TA0	TA1	
P	MA9	MA10	MA11	MA4	MVREF	P	Address	P	GND		GND		GND		GND		GND		P	P		GND	TA8	TWE#	TA6	TA7	
R	MA5	MA6	MA7	MAB0	MVCC	R		R	GND		GND		GND		GND		GND		R	R		GND	BWE#	CCS1#	COE1#	TA9	
T	MAB1	MA2	MA3	CAS2#	MVCC	T		T	GND		GND		GND		GND		GND		T	T		HD1	HD0	CADV#	CADS#	GWE#	
U	SRASC	SRASB#	SRASA#	DS0#	MVCC	U	Control	U	GND		GND		GND		GND		GND		U	U		HVCC	HD5	HD4	HD3	HD2	
V	CAS0#	CAS4#	CAS6#	DS2#	MVCC	V		V	GND		GND		GND		GND		GND		V	V		HVCC	HD9	HD8	HD7	HD6	
W	SCASC	SCASB#	SCASA#	MPD5	MPD1	W		W	9	10	11	12	13	14	15	16	17	18	CPU Pins			W	HD14	HD13	HD12	HD11	HD10
Y	MD46	MD15	MD47	MPD4	GND	Y	Data	Y	Control		Address		CPU Pins		Byte Enables		Data		Y	Y		GND	HD19	HD18	HD17	HD16	HD15
AA	MD13	MD45	MD14	MPD0	GND	AA6	7	8	9	10	11	12	13	14	15	16	17	18	19	20	AA21	GND	HD23	HD22	HD21	HD20	
AB	MD43	MD12	MD44	MD11	CVCC	MVCC	MVCC	5VREF	HVCC	HVCC	HA25	HA30	GND		HA8	BE5#	HVCC	HVCC	HVCC	HD52	CVCC	GND	HD27	HD26	HD25	HD24	
AC	MD41	MD10	MD42	MD9	MD33	MD32	MD1	BRDY#	M/IO#	HA27	HA28	HA17	HA14	HA3	HA7	BE6#	BE1#	HD61	HD57	HD53	HD48	HD44	HD31	HD30	HD29	HD28	
AD	MD8	MD40	MD37	MD4	MD34	MD0	ADS#	NA#	CACHE	HA26	HA29	HA18	HA15	HA11	HA6	BE7#	BE2#	HD62	HD58	HD54	HD49	HD45	HD41	HD38	HD33	HD32	
AE	MD39	MD38	MD5	MD35	MD2	EADS#	D/C#	BOFF#	AHOLD	HA24	HA31	HA19	HA16	HA12	HA5	HA10	BE3#	HD63	HD59	HD55	HD50	HD46	HD42	HD39	HD36	HD34	
AF	MD7	MD6	MD36	MD3	HLOCK#	W/R#	HITM#	SMACT#	KEN#	HA23	HA21	HA22	HA20	HA13	HA4	HA9	BE4#	BE0#	HD60	HD56	HD51	HD47	HD43	HD40	HD37	HD35	

Figure 3. VT82C597 Pin List (Numerical Order)

Pin #	Pin Name	Pin #	Pin Name	Pin #	Pin Name	Pin #	Pin Name	Pin #	Pin Name	Pin #	Pin Name
A01	IO MD58	D02	IO MD54	H25	O GNT3#	P02	O MA10	W05	IO MPD1	AD02	IO MD40
A02	IO MD27	D03	IO MD23	H26	IO AD14	P03	O MA11	W22	IO HD14	AD03	IO MD37
A03	IO MD28	D04	IO MD55	J01	O CAS7# / DOM7#	P04	O MA04	W23	IO HD13	AD04	IO MD04
A04	IO MD61	D05	IO MD30	J02	O SWEA# / MWEA#	P05	P MVREF	W24	IO HD12	AD05	IO MD34
A05	IO MD63	D06	IO GD08	J03	O SWEB# / MWEB#	P11	P GND	W25	IO HD11	AD06	IO MD00
A06	IO GD01	D07	IO GD03	J04	IO MPD3	P12	P GND	W26	IO HD10	AD07	IO ADS#
A07	IO GD07	D08	P GND	J05	P MVCC	P13	P GND	Y01	IO MD46	AD08	O NA#
A08	IO GBE0#	D09	IO GD10	J09	P GND	P14	P GND	Y02	IO MD15	AD09	I CACHE#
A09	IO GD11	D10	IO GD14	J14	P GND	P15	P GND	Y03	IO MD47	AD10	IO HA26
A10	IO GBE1#	D11	IO GBE2#	J18	P GND	P16	P GND	Y04	IO MPD4	AD11	IO HA29
A11	IO GTRDY#	D12	IO GD21	J22	P PVCC	P17	P GND	Y05	P GND	AD12	IO HA18
A12	IO GD17	D13	IO GD23	J23	IO AD08	P18	P GND	Y22	IO HD19	AD13	IO HA15
A13	IO GD20	D14	IO GDS1#	J24	IO AD15	P22	P GND	Y23	IO HD18	AD14	IO HA11
A14	IO GD25	D15	IO GD27	J25	IO CBE1#	P23	IO TA8	Y24	IO HD17	AD15	IO HA06
A15	IO GD28	D16	I SBA6	J26	IO DEVSEL#	P24	O TWE#	Y25	IO HD16	AD16	IO BE7#
A16	IO GD31	D17	I SBA2	K01	O CAS1# / DOM1#	P25	IO TA6	Y26	IO HD15	AD17	IO BE2#
A17	I SBA5	D18	I SBA0	K02	O CAS5# / DOM5#	P26	IO TA7	AA01	IO MD13	AD18	IO HD62
A18	I SBA1	D19	I PCLK	K03	O CAS3# / DOM3#	R01	O MA05	AA02	IO MD45	AD19	IO HD58
A19	O ST0	D20	IO PAR	K04	IO MPD2	R02	O MA06	AA03	IO MD14	AD20	IO HD54
A20	I GREO#	D21	O ST2	K05	P AGND	R03	O MA07	AA04	IO MPD0	AD21	IO HD49
A21	IO GPAR	D22	IO AD00	K10	P GND	R04	O MAB0	AA05	P GND	AD22	IO HD45
A22	IO STOP#	D23	IO AD01	K14	P GND	R05	P MVCC	AA22	P GND	AD23	IO HD41
A23	IO AD17	D24	IO AD27	K17	P GND	R11	P GND	AA23	IO HD23	AD24	IO HD38
A24	IO AD21	D25	IO AD26	K22	P PVCC	R12	P GND	AA24	IO HD22	AD25	IO HD33
A25	IO AD22	D26	IO AD28	K23	IO CBE0#	R13	P GND	AA25	IO HD21	AD26	IO HD32
A26	IO AD23	E01	IO MD52	K24	IO AD09	R14	P GND	AA26	IO HD20	AE01	IO MD39
B01	IO MD57	E02	IO MD21	K25	IO TRDY#	R15	P GND	AB01	IO MD43	AE02	IO MD38
B02	IO MD26	E03	IO MD53	K26	IO IRDY#	R16	P GND	AB02	IO MD12	AE03	IO MD05
B03	IO MD59	E04	O DS3#	L01	O RAS3# / CS3#	R22	P GND	AB03	IO MD44	AE04	IO MD35
B04	IO MD29	E05	P CVCC	L02	O RAS1# / CS1#	R23	O BWE#	AB04	IO MD11	AE05	IO MD02
B05	IO MD31	E06	P GND	L03	O RAS0# / CS0#	R24	O CCS1#	AB05	P CVCC	AE06	O EADS#
B06	IO GD00	E07	P GND	L04	IO MPD6	R25	O COE1#	AB06	P MVCC	AE07	O D/C#
B07	IO GD04	E08	I GCLK	L05	P GND	R26	IO TA9	AB07	P MVCC	AE08	O BOFF#
B08	IO GDS0#	E09	P GVCC	L11	P GND	T01	O MAB1	AB08	P SVREF	AE09	O AHOLD
B09	IO GD12	E10	P GVCC	L12	P GND	T02	O MA02	AB09	P HVCC	AE10	IO HA24
B10	IO GD15	E11	P GVCC	L13	P GND	T03	O MA03	AB10	P HVCC	AE11	IO HA31
B11	IO GDSEL#	E12	IO GD16	L14	P GND	T04	O CAS2# / DOM2#	AB11	IO HA25	AE12	IO HA19
B12	IO GFRM#	E13	P GVREF	L15	P GND	T05	P MVCC	AB12	IO HA30	AE13	IO HA16
B13	IO GD19	E14	P GND	L16	P GND	T11	P GND	AB13	P GND	AE14	IO HA12
B14	IO GBE3#	E15	P GND	L22	P PVCC	T12	P GND	AB14	P GND	AE15	IO HA05
B15	IO GD26	E16	P GND	L23	IO AD10	T13	P GND	AB15	IO HA08	AE16	IO HA10
B16	IO GD29	E17	P GVCC	L24	IO AD12	T14	P GND	AB16	IO BE5#	AE17	IO BE3#
B17	I SBA4	E18	P GVCC	L25	IO FRAME#	T15	P GND	AB17	P HVCC	AE18	IO HD63
B18	I SBA3	E19	P GVCC	L26	O PGNT#	T16	P GND	AB18	P HVCC	AE19	IO HD59
B19	I GPIPE#	E20	- Reserved	M01	O MAA1	T22	IO HD01	AB19	P HVCC	AE20	IO HD55
B20	O ST1	E21	P SVREF	M02	O RAS5# / CS5#	T23	IO HD00	AB20	IO HD52	AE21	IO HD50
B21	O GGNT#	E22	P GND	M03	O RAS4# / CS4#	T24	O CADV#	AB21	P CVCC	AE22	IO HD46
B22	IO LOCK#	E23	IO AD02	M04	O RAS2# / CS2#	T25	O CADS#	AB22	P GND	AE23	IO HD42
B23	IO AD16	E24	IO AD29	M05	P GND	T26	O GWE#	AB23	IO HD27	AE24	IO HD39
B24	IO AD19	E25	IO AD30	M11	P GND	U01	O SRASC#	AB24	IO HD26	AE25	IO HD36
B25	IO AD20	E26	IO AD31	M12	P GND	U02	O SRASB#	AB25	IO HD25	AE26	IO HD34
B26	IO CBE3#	F01	IO MD19	M13	P GND	U03	O SRASA#	AB26	IO HD24	AF01	IO MD07
C01	IO MD24	F02	IO MD51	M14	P GND	U04	O DS0#	AC01	IO MD41	AF02	IO MD06
C02	IO MD56	F03	IO MD20	M15	P GND	U05	P MVCC	AC02	IO MD10	AF03	IO MD36
C03	IO MD25	F04	O DS1#	M16	P GND	U10	P GND	AC03	IO MD42	AF04	IO MD03
C04	IO MD60	F05	P AVCC	M22	IO AD11	U13	P GND	AC04	IO MD9	AF05	I HLOCK#
C05	IO MD62	F22	P CVCC	M23	IO AD13	U17	P GND	AC05	IO MD33	AF06	IO W/R#
C06	IO GD05	F23	IO AD03	M24	I PREQ#	U22	P HVCC	AC06	IO MD32	AF07	I HITM#
C07	IO GD02	F24	I REQ0#	M25	I RESET#	U23	IO HD05	AC07	IO MD01	AF08	I SMIACT#
C08	IO GD06	F25	O GNT0#	M26	IO TA2	U24	IO HD04	AC08	IO BRDY#	AF09	O KEN#
C09	IO GD09	F26	I REQ1#	N01	O MA12	U25	IO HD03	AC09	IO M/IO#	AF10	IO HA23
C10	IO GD13	G01	IO MD49	N02	O MA13	U26	IO HD02	AC10	IO HA27	AF11	IO HA21
C11	IO GSTOP#	G02	IO MD18	N03	O MAA0	V01	O CAS0# / DOM0#	AC11	IO HA28	AF12	IO HA22
C12	IO GIRDY#	G03	IO MD50	N04	O MA08	V02	O CAS4# / DOM4#	AC12	IO HA17	AF13	IO HA20
C13	IO GD18	G04	IO MD17	N05	I HCLK	V03	O CAS6# / DOM6#	AC13	IO HA14	AF14	IO HA13
C14	IO GD22	G05	P MVCC	N09	P GND	V04	O DS2#	AC14	IO HA03	AF15	IO HA04
C15	IO GD24	G22	IO AD05	N10	P GND	V05	P MVCC	AC15	IO HA07	AF16	IO HA09
C16	IO GD30	G23	IO AD04	N11	P GND	V09	P GND	AC16	IO BE6#	AF17	IO BE4#
C17	I SBA7	G24	O GNT1#	N12	P GND	V13	P GND	AC17	IO BE1#	AF18	IO BE0#
C18	I SBS#	G25	I REQ2#	N13	P GND	V18	P GND	AC18	IO HD61	AF19	IO HD60
C19	I GRBF#	G26	O GNT2#	N14	P GND	V22	P HVCC	AC19	IO HD57	AF20	IO HD56
C20	IO GSERR#	H01	O SWEC# / MWECS#	N15	P GND	V23	IO HD09	AC20	IO HD53	AF21	IO HD51
C21	- Reserved	H02	IO MD16	N16	P GND	V24	IO HD08	AC21	IO HD48	AF22	IO HD47
C22	IO SERR#	H03	IO MD48	N22	IO TA5	V25	IO HD07	AC22	IO HD44	AF23	IO HD43
C23	IO CBE2#	H04	IO MPD7	N23	IO TA4	V26	IO HD06	AC23	IO HD31	AF24	IO HD40
C24	IO AD18	H05	P MVCC	N24	IO TA3	W01	O SCASC#	AC24	IO HD30	AF25	IO HD37
C25	IO AD24	H22	IO AD06	N25	IO TA0	W02	O SCASB#	AC25	IO HD29	AF26	IO HD35
C26	IO AD25	H23	IO AD07	N26	IO TA1	W03	O SCASA#	AC26	IO HD28		
D01	IO MD22	H24	I REQ3#	P01	O MA09	W04	IO MPD5	AD01	IO MD8		

Figure 4. VT82C597 Pin List (Alphabetical Order)

Pin #	Pin Name	Pin #	Pin Name	Pin #	Pin Name	Pin #	Pin Name	Pin #	Pin Name	Pin #	Pin Name
AB08	P 5VREF	L25	IO FRAME#	P13	P GND	AE11	IO HA31	T02	O MA02	A05	IO MD63
E21	P 5VREF	A08	IO GBE0#	P14	P GND	N05	I HCLK	T03	O MA03	AA04	IO MPD0
D22	IO AD00	A10	IO GBE1#	P15	P GND	T23	IO HD00	P04	O MA04	W05	IO MPD1
D23	IO AD01	D11	IO GBE2#	P16	P GND	T22	IO HD01	R01	O MA05	K04	IO MPD2
E23	IO AD02	B14	IO GBE3#	P17	P GND	U26	IO HD02	R02	O MA06	J04	IO MPD3
F23	IO AD03	E08	I GCLK	P18	P GND	U25	IO HD03	R03	O MA07	Y04	IO MPD4
G23	IO AD04	B06	IO GD00	P22	P GND	U24	IO HD04	N04	O MA08	W04	IO MPD5
G22	IO AD05	A06	IO GD01	R11	P GND	U23	IO HD05	P01	O MA09	L04	IO MPD6
H22	IO AD06	C07	IO GD02	R12	P GND	V26	IO HD06	P02	O MA10	H04	IO MPD7
H23	IO AD07	D07	IO GD03	R13	P GND	V25	IO HD07	P03	O MA11	G05	P MVCC
J23	IO AD08	B07	IO GD04	R14	P GND	V24	IO HD08	N01	O MA12	H05	P MVCC
K24	IO AD09	C06	IO GD05	R15	P GND	V23	IO HD09	N02	O MA13	J05	P MVCC
L23	IO AD10	C08	IO GD06	R16	P GND	W26	IO HD10	N03	O MAA0	R05	P MVCC
M22	IO AD11	A07	IO GD07	R22	P GND	W25	IO HD11	M01	O MAA1	T05	P MVCC
L24	IO AD12	D06	IO GD08	T11	P GND	W24	IO HD12	R04	O MAB0	U05	P MVCC
M23	IO AD13	C09	IO GD09	T12	P GND	W23	IO HD13	T01	O MAB1	V05	P MVCC
H26	IO AD14	D09	IO GD10	T13	P GND	W22	IO HD14	AD06	IO MD00	AB06	P MVCC
J24	IO AD15	A09	IO GD11	T14	P GND	Y26	IO HD15	AC07	IO MD01	AB07	P MVCC
B23	IO AD16	B09	IO GD12	T15	P GND	Y25	IO HD16	AE05	IO MD02	P05	P MVREF
A23	IO AD17	C10	IO GD13	T16	P GND	Y24	IO HD17	AF04	IO MD03	AD08	O NA#
C24	IO AD18	D10	IO GD14	U10	P GND	Y23	IO HD18	AD04	IO MD04	D20	IO PAR
B24	IO AD19	B10	IO GD15	U13	P GND	Y22	IO HD19	AE03	IO MD05	D19	I PCLK
B25	IO AD20	E12	IO GD16	U17	P GND	AA26	IO HD20	AF02	IO MD06	L26	O PGNT#
A24	IO AD21	A12	IO GD17	V09	P GND	AA25	IO HD21	AF01	IO MD07	M24	I PREQ#
A25	IO AD22	C13	IO GD18	V13	P GND	AA24	IO HD22	AD01	IO MD08	J22	P PVCC
A26	IO AD23	B13	IO GD19	V18	P GND	AA23	IO HD23	AC04	IO MD09	K22	P PVCC
C25	IO AD24	A13	IO GD20	Y05	P GND	AB26	IO HD24	AC02	IO MD10	L22	P PVCC
C26	IO AD25	D12	IO GD21	AA05	P GND	AB25	IO HD25	AB04	IO MD11	L03	O RAS0# / CS0#
D25	IO AD26	C14	IO GD22	AA22	P GND	AB24	IO HD26	AB02	IO MD12	L02	O RAS1# / CS1#
D24	IO AD27	D13	IO GD23	AB13	P GND	AB23	IO HD27	AA01	IO MD13	M04	O RAS2# / CS2#
D26	IO AD28	C15	IO GD24	AB14	P GND	AC26	IO HD28	AA03	IO MD14	L01	O RAS3# / CS3#
E24	IO AD29	A14	IO GD25	AB22	P GND	AC25	IO HD29	Y02	IO MD15	M03	O RAS4# / CS4#
E25	IO AD30	B15	IO GD26	F25	O GNT0#	AC24	IO HD30	H02	IO MD16	M02	O RAS5# / CS5#
E26	IO AD31	D15	IO GD27	G24	O GNT1#	AC23	IO HD31	G04	IO MD17	F24	I REQ0#
AD07	IO ADS#	A15	IO GD28	G26	O GNT2#	AD26	IO HD32	G02	IO MD18	F26	I REQ1#
B08	IO GDS0#	B16	IO GD29	H25	O GNT3#	AD25	IO HD33	F01	IO MD19	G25	I REQ2#
D14	IO GDS1#	C16	IO GD30	A21	IO GPAR	AE26	IO HD34	F03	IO MD20	H24	I REQ3#
K05	P AGND	A16	IO GD31	B19	I GPIPE#	AF26	IO HD35	E02	IO MD21	C21	- Reserved
AE09	O AHOLD	B11	IO GDSEL#	C19	I GRBF#	AE25	IO HD36	D01	IO MD22	E20	- Reserved
F05	P AVCC	B12	IO GFRM#	A20	I GREQ#	AF25	IO HD37	D03	IO MD23	M25	I RESET#
AF18	IO BE0#	B21	O GGNT#	C20	IO GSERR#	AD24	IO HD38	C01	IO MD24	D18	I SBA0
AC17	IO BE1#	C12	IO GIRDY#	C11	IO GSTOP#	AE24	IO HD39	C03	IO MD25	A18	I SBA1
AD17	IO BE2#	D08	P GND	A11	IO GTRDY#	AF24	IO HD40	B02	IO MD26	D17	I SBA2
AE17	IO BE3#	E06	P GND	E09	P GVCC	AD23	IO HD41	A02	IO MD27	B18	I SBA3
AF17	IO BE4#	E07	P GND	E10	P GVCC	AE23	IO HD42	A03	IO MD28	B17	I SBA4
AB16	IO BE5#	E14	P GND	E11	P GVCC	AF23	IO HD43	B04	IO MD29	A17	I SBA5
AC16	IO BE6#	E15	P GND	E17	P GVCC	AC22	IO HD44	D05	IO MD30	D16	I SBA6
AD16	IO BE7#	E16	P GND	E18	P GVCC	AD22	IO HD45	B05	IO MD31	C17	I SBA7
AE08	O BOFF#	E22	P GND	E19	P GVCC	AE22	IO HD46	AC06	IO MD32	C18	I SBS#
AC08	IO BRDY#	J09	P GND	E13	P GVREF	AF22	IO HD47	AC05	IO MD33	W03	O SCASA#
R23	O BWE#	J14	P GND	T26	O GWE#	AC21	IO HD48	AD05	IO MD34	W02	O SCASB#
AD09	I CACHE#	J18	P GND	AC14	IO HA03	AD21	IO HD49	AE04	IO MD35	W01	O SCASC#
T25	O CADS#	K10	P GND	AF15	IO HA04	AE21	IO HD50	AF03	IO MD36	C22	IO SFERR#
T24	O CADV#	K14	P GND	AE15	IO HA05	AF21	IO HD51	AD03	IO MD37	AF08	I SMIACT#
V01	O CAS0# / DQM0#	K17	P GND	AD15	IO HA06	AB20	IO HD52	AE02	IO MD38	U03	O SRASA#
K01	O CAS1# / DQM1#	L05	P GND	AC15	IO HA07	AC20	IO HD53	AE01	IO MD39	U02	O SRASB#
T04	O CAS2# / DQM2#	L11	P GND	AB15	IO HA08	AD20	IO HD54	AD02	IO MD40	U01	O SRASC#
K03	O CAS3# / DQM3#	L12	P GND	AF16	IO HA09	AE20	IO HD55	AC01	IO MD41	A19	O ST0
V02	O CAS4# / DQM4#	L13	P GND	AE16	IO HA10	AF20	IO HD56	AC03	IO MD42	B20	O ST1
K02	O CAS5# / DQM5#	L14	P GND	AD14	IO HA11	AC19	IO HD57	AB01	IO MD43	D21	O ST2
V03	O CAS6# / DQM6#	L15	P GND	AE14	IO HA12	AD19	IO HD58	AB03	IO MD44	A22	IO STOP#
J01	O CAS7# / DQM7#	L16	P GND	AF14	IO HA13	AE19	IO HD59	AA02	IO MD45	J02	O SWEA# / MWEA#
K23	IO CBE0#	M05	P GND	AC13	IO HA14	AF19	IO HD60	Y01	IO MD46	J03	O SWEB# / MWEB#
J25	IO CBE1#	M11	P GND	AD13	IO HA15	AC18	IO HD61	Y03	IO MD47	H01	O SWEC# / MWEC#
C23	IO CBE2#	M12	P GND	AE13	IO HA16	AD18	IO HD62	H03	IO MD48	N25	IO TA0
B26	IO CBE3#	M13	P GND	AC12	IO HA17	AE18	IO HD63	G01	IO MD49	N26	IO TA1
R24	O CCS1#	M14	P GND	AD12	IO HA18	AF07	I HITM#	G03	IO MD50	M26	IO TA2
R25	O COE1#	M15	P GND	AE12	IO HA19	AF05	I HLOCK#	F02	IO MD51	N24	IO TA3
E05	P CVCC	M16	P GND	AF13	IO HA20	AB09	P HVCC	E01	IO MD52	N23	IO TA4
F22	P CVCC	N09	P GND	AF11	IO HA21	AB10	P HVCC	E03	IO MD53	N22	IO TA5
AB05	P CVCC	N10	P GND	AF12	IO HA22	AB17	P HVCC	D02	IO MD54	P25	IO TA6
AB21	P CVCC	N11	P GND	AF10	IO HA23	AB18	P HVCC	D04	IO MD55	P26	IO TA7
AE07	IO D/C#	N12	P GND	AE10	IO HA24	AB19	P HVCC	C02	IO MD56	P23	IO TA8
J26	IO DEVSEL#	N13	P GND	AB11	IO HA25	U22	P HVCC	B01	IO MD57	R26	IO TA9
U04	O DS0#	N14	P GND	AD10	IO HA26	V22	P HVCC	A01	IO MD58	K25	IO TRDY#
F04	O DS1#	N15	P GND	AC10	IO HA27	K26	IO IRDY#	B03	IO MD59	P24	O TWE#
V04	O DS2#	N16	P GND	AC11	IO HA28	AF09	O KEN#	C04	IO MD60	AF06	IO W/R#
E04	O DS3#	P11	P GND	AD11	IO HA29	B22	IO LOCK#	A04	IO MD61		
AE06	O EADS#	P12	P GND	AB12	IO HA30	AC09	IO M/IO#	C05	IO MD62		

PINOUTS

Figure 5. VT82C597AT Ball Diagram (Top View)

Key	1	2	3	4	5	6	7	8	9	10	11	12	13	14	15	16	17	18	19	20	21	22	23	24	25	26																	
A	SBA5	SBA3	GPIPE#	GREQ#	GSERR#	SBA0	MD0	MD33	MD35	MD37	MD39	MD41	MD12	MD46	MPD4	SCASC#	CAS0#	SRASC#	MAB1	MA5	MA9	MA13	RAS4#	RAS1#	CAS2#	CAS3#																	
B	SBA6	SBS#	GRBF#	ST1	GGNT#	GPARG	MD32	MD2	MD4	MD6	MD8	MD10	MD44	MD15	MPD1	SCASB#	CAS4#	SRASB#	MA2	MA6	MA10	MAA0	RAS3#	RAS0#	CAS6#	CAS7#																	
C	GD31	SBA7	SBA1	ST0	SBA2	-res-	MD1	MD34	MD36	MD38	MD40	MD42	MD13	MD47	MPD5	SCASA#	CAS5#	SRASA#	MA3	MA7	MA11	MAA1	RAS2#	SWEC#	SWEB#	SWEA#																	
D	GD28	GD30	GD29	GCLK	SBA4	-res-	MD3	GND	MD5	MD7	MD9	MD11	MD45	MPD0	DS0#	DS2#	CAS1#	MAB0	MA4	MA8	MA12	RAS5#	MPD7	MPD3	MPD6	MPD2																	
E	GD24	GD26	GDS1#	GD27	CVCC	GND	GND	ST2	MVCC	MVCC	MVCC	MD43	MD14	GND	GND	GND	MVCC	MVCC	MVCC	MVREF	SVREF	GND	MD49	MD17	MD48	MD16																	
F	GBE3#	GD25	GD21	GD23	GVREF	F6	7	8	9	10	11	12	13	14	15	16	17	18	19	20	F21	CVCC	MD51	MD19	MD50	MD18																	
G	GD20	GD22	GBE2#	GD17	GVCC	G	Total = 472 Pins										Data	Control	Address	Control	G	DS1#	MD53	MD21	MD52	MD20																	
H	GD16	GD18	GD19	GDSEL#	GVCC	H	AGP Pins										9	10	11	12	13	14	15	16	17	18	Data	H	DS3#	MD55	MD23	MD54	MD22										
J	GTRDY#	GIRDY#	GFRM#	GBE1#	GVCC	J	J Pins										J	GND	J	GND	J	GND	J	Mem	J	MVCC	MD57	MD25	MD56	MD24													
K	GD13	GD15	GSTOP#	GD14	AVCC	K	K Pins										K	GND	11	12	13	GND	15	16	GND	K	MVCC	MD59	MD27	MD58	MD26												
L	GD9	GD12	GD11	GD10	GND	L	L Pins										L	GND	GND	GND	GND	GND	GND	L	MVCC	MD61	MD29	MD60	MD28														
M	GD6	GD8	GBE0#	GDS0#	GND	M	M Pins										M	GND	GND	GND	GND	GND	GND	M	TA2	MD63	MD31	MD62	MD30														
N	GD2	GD4	GD7	GD5	AGND	N	N Pins										N	GND	GND	GND	GND	GND	GND	N	TA5	TA4	TA3	TA0	TA1														
P	GD3	GD1	GD0	GNT3#	HCLK	P	P Pins										P	GND	GND	GND	GND	GND	GND	GND	GND	GND	P	Cache	GND	TA8	TWE#	TA6	TA7										
R	GNT1#	REQ2#	GNT2#	REQ3#	PVCC	R	R Pins										R	GND	GND	GND	GND	GND	GND	R	GND	BWE#	CCS1#	COE1#	TA9														
T	LOCK#	REQ0#	GNT0#	REQ1#	PVCC	T	T Pins										T	GND	GND	GND	GND	GND	GND	T	HD1	HD0	CADV#	CADS#	GWE#														
U	AD28	AD29	AD30	AD31	PVCC	U	U Pins										U	GND	U	GND	U	GND	U	HVCC	HD5	HD4	HD3	HD2															
V	AD24	AD25	AD26	AD27	PVCC	V	V Pins										V	GND	V	GND	V	GND	V	HVCC	HD9	HD8	HD7	HD6															
W	AD21	AD22	AD23	CBE3#	PCLK	W	W Pins										W	9	10	11	12	13	14	15	16	17	18	Data	W	HD14	HD13	HD12	HD11	HD10									
Y	AD17	AD18	AD19	AD20	GND	Y	Y Pins										Y	Control					Address					CPU Pins					Byte Enables					Y	HD19	HD18	HD17	HD16	HD15
AA	IRDY#	FRM#	CBE2#	AD16	GND	AA6	7	8	9	10	11	12	13	14	15	16	17	18	19	20	AA21	GND	HD23	HD22	HD21	HD20																	
AB	STOP#	DSEL#	TRDY#	SERR#	CVCC	PVCC	PVCC	SVREF	HVCC	HVCC	HA25	HA30	GND	GND	HA8	BE5#	HVCC	HVCC	HVCC	HD52	CVCC	GND	HD27	HD26	HD25	HD24																	
AC	CBE1#	PAR	AD15	AD14	AD2	PREQ#	RESET#	BRDY#	M/IO#	HA27	HA28	HA17	HA14	HA3	HA7	BE6#	BE1#	HD61	HD57	HD53	HD48	HD44	HD31	HD30	HD29	HD28																	
AD	AD13	AD12	AD11	AD5	AD1	PGNT#	ADS#	NA#	CACHE#	HA26	HA29	HA18	HA15	HA11	HA6	BE7#	BE2#	HD62	HD58	HD54	HD49	HD45	HD41	HD38	HD33	HD32																	
AE	AD10	AD9	AD7	AD4	AD0	EADS#	D/C#	BOFF#	AHOLD	HA24	HA31	HA19	HA16	HA12	HA5	HA10	BE3#	HD63	HD59	HD55	HD50	HD46	HD42	HD39	HD36	HD34																	
AF	AD8	CBE0#	AD6	AD3	HLOCK#	W/R#	HITM#	SMACT#	KEN#	HA23	HA21	HA22	HA20	HA13	HA4	HA9	BE4#	BE0#	HD60	HD56	HD51	HD47	HD43	HD40	HD37	HD35																	

Figure 6. VT82C597AT Pin List (Numerical Order)

Pin #	Pin Name	Pin #	Pin Name	Pin #	Pin Name	Pin #	Pin Name	Pin #	Pin Name	Pin #	Pin Name
A01	I SBA5	D02	IO GD30	H25	IO MD54	P02	IO GD01	W05	I PCLK	AD02	IO AD12
A02	I SBA3	D03	IO GD29	H26	IO MD22	P03	IO GD00	W22	IO HD14	AD03	IO AD11
A03	I GPIPE#	D04	I GCLK	J01	IO GTRDY#	P04	O GNT3#	W23	IO HD13	AD04	IO AD05
A04	I GREQ#	D05	I SBA4	J02	IO GIRDY#	P05	I HCLK	W24	IO HD12	AD05	IO AD01
A05	IO GSERR#	D06	- Reserved	J03	IO GFRM#	P11	P GND	W25	IO HD11	AD06	O PGNT#
A06	I SBA0	D07	IO MD03	J04	IO GBE1#	P12	P GND	W26	IO HD10	AD07	IO ADS#
A07	IO MD00	D08	P GND	J05	P GVCC	P13	P GND	Y01	IO AD17	AD08	O NA#
A08	IO MD33	D09	IO MD05	J09	P GND	P14	P GND	Y02	IO AD18	AD09	I CACHE#
A09	IO MD35	D10	IO MD07	J14	P GND	P15	P GND	Y03	IO AD19	AD10	IO HA26
A10	IO MD37	D11	IO MD09	J18	P GND	P16	P GND	Y04	IO AD20	AD11	IO HA29
A11	IO MD39	D12	IO MD11	J22	P MVCC	P17	P GND	Y05	P GND	AD12	IO HA18
A12	IO MD41	D13	IO MD45	J23	IO MD57	P18	P GND	Y22	IO HD19	AD13	IO HA15
A13	IO MD12	D14	IO MPD0	J24	IO MD25	P22	P GND	Y23	IO HD18	AD14	IO HA11
A14	IO MD46	D15	O DS0#	J25	IO MD56	P23	IO TA8	Y24	IO HD17	AD15	IO HA06
A15	IO MPD4	D16	O DS2#	J26	IO MPD4	P24	O TWE#	Y25	IO HD16	AD16	IO BE7#
A16	O SCASC#	D17	O CAS1# / DOM1#	K01	IO GD13	P25	IO TA6	Y26	IO HD15	AD17	IO BE2#
A17	O CAS0# / DOM0#	D18	O MAB0	K02	IO GD15	P26	IO TA7	AA01	IO IRDY#	AD18	IO HD62
A18	O SRASC#	D19	O MA04	K03	IO GSTOP#	R01	O GNT1#	AA02	IO FRAME#	AD19	IO GNT8
A19	O MAB1	D20	O MA08	K04	IO GD14	R02	I REQ2#	AA03	IO CBE2#	AD20	IO HD54
A20	O MA05	D21	O MA12	K05	P AVCC	R03	O GNT2#	AA04	IO AD16	AD21	IO HD49
A21	O MA09	D22	O RAS5# / CS5#	K10	P GND	R04	I REQ3#	AA05	P GND	AD22	IO HD45
A22	O MA13	D23	IO MPD7	K14	P GND	R05	P PVCC	AA22	P GND	AD23	IO HD41
A23	O RAS4# / CS4#	D24	IO MPD3	K17	P GND	R11	P GND	AA23	IO HD23	AD24	IO HD38
A24	O RAS1# / CS1#	D25	IO MPD6	K22	P MVCC	R12	P GND	AA24	IO HD22	AD25	IO HD33
A25	O CAS2# / DOM2#	D26	IO MPD2	K23	IO MD59	R13	P GND	AA25	IO HD21	AD26	IO HD32
A26	O CAS3# / DOM3#	E01	IO GD24	K24	IO MD27	R14	P GND	AA26	IO HD20	AE01	IO AD10
B01	I SBA6	E02	IO GD26	K25	IO MD58	R15	P GND	AB01	IO STOP#	AE02	IO AD09
B02	I SBS#	E03	IO GDS1#	K26	IO MD26	R16	P GND	AB02	IO DEVSEL#	AE03	IO AD07
B03	I GRBF#	E04	IO GD27	L01	IO GD09	R22	P GND	AB03	IO TRDY#	AE04	IO AD04
B04	O ST1	E05	P CVCC	L02	IO GD12	R23	O BWE#	AB04	IO SERR#	AE05	IO AD00
B05	O GGNT#	E06	P GND	L03	IO GD11	R24	O CCS1#	AB05	P CVCC	AE06	O EADS#
B06	IO GPAR	E07	P GND	L04	IO GD10	R25	O COE1#	AB06	P PVCC	AE07	IO D/C#
B07	IO MD32	E08	O ST2	L05	P GND	R26	IO TA9	AB07	P PVCC	AE08	O BOFF#
B08	IO MD02	E09	P MVCC	L11	P GND	T01	IO LOCK#	AB08	P SVREF	AE09	O AHOLD
B09	IO MD04	E10	P MVCC	L12	P GND	T02	I REQ0#	AB09	P HVCC	AE10	IO HA24
B10	IO MD06	E11	P MVCC	L13	P GND	T03	O GNT0#	AB10	P HVCC	AE11	IO HA31
B11	IO MD08	E12	IO MD43	L14	P GND	T04	I REQ1#	AB11	IO HA25	AE12	IO HA19
B12	IO MD10	E13	IO MD14	L15	P GND	T05	P PVCC	AB12	IO HA30	AE13	IO HA16
B13	IO MD44	E14	P GND	L16	P GND	T11	P GND	AB13	P GND	AE14	IO HA12
B14	IO MD15	E15	P GND	L22	P MVCC	T12	P GND	AB14	P GND	AE15	IO HA05
B15	IO MPD1	E16	P GND	L23	IO MD61	T13	P GND	AB15	IO HA08	AE16	IO HA10
B16	O SCASB#	E17	P MVCC	L24	IO MD29	T14	P GND	AB16	IO BE5#	AE17	IO BE3#
B17	O CAS4# / DOM4#	E18	P MVCC	L25	IO MD60	T15	P GND	AB17	P HVCC	AE18	IO HD63
B18	O SRASB#	E19	P MVCC	L26	IO MD28	T16	P GND	AB18	P HVCC	AE19	IO HD59
B19	O MA02	E20	P MVREF	M01	IO GD06	T22	IO HD01	AB19	P HVCC	AE20	IO HD55
B20	O MA06	E21	P SVREF	M02	IO GD08	T23	IO HD00	AB20	IO HD52	AE21	IO HD50
B21	O MA10	E22	P GND	M03	IO GBE0#	T24	O CADV#	AB21	P CVCC	AE22	IO HD46
B22	O MAA0	E23	IO MD49	M04	IO GDS0#	T25	O CADS#	AB22	P GND	AE23	IO HD42
B23	O RAS3# / CS3#	E24	IO MD17	M05	P GND	T26	O GWE#	AB23	IO HD27	AE24	IO HD39
B24	O RAS0# / CS0#	E25	IO MD48	M11	P GND	U01	IO AD28	AB24	IO HD26	AE25	IO HD36
B25	O CAS6# / DOM6#	E26	IO MD16	M12	P GND	U02	IO AD29	AB25	IO HD25	AE26	IO HD34
B26	O CAS7# / DOM7#	F01	IO GBE3#	M13	P GND	U03	IO AD30	AB26	IO HD24	AF01	IO AD08
C01	IO GD31	F02	IO GD25	M14	P GND	U04	IO AD31	AC01	IO CBE1#	AF02	IO CBE0#
C02	I SBA7	F03	IO GD21	M15	P GND	U05	P PVCC	AC02	IO PAR	AF03	IO AD06
C03	I SBA1	F04	IO GD23	M16	P GND	U10	P GND	AC03	IO AD15	AF04	IO AD03
C04	O ST0	F05	P GVREF	M22	IO TA2	U13	P GND	AC04	IO AD14	AF05	I HLOCK#
C05	I SBA2	F22	P CVCC	M23	IO MD63	U17	P GND	AC05	IO AD02	AF06	IO W/R#
C06	- Reserved	F23	IO MD51	M24	IO MD31	U22	P HVCC	AC06	I PRE0#	AF07	I HITM#
C07	IO MD01	F24	IO MD19	M25	IO MD62	U23	IO HD05	AC07	I RESET#	AF08	I SMIACT#
C08	IO MD34	F25	IO MD50	M26	IO MD30	U24	IO HD04	AC08	IO BRDY#	AF09	O KEN#
C09	IO MD36	F26	IO MD18	N01	IO GD02	U25	IO HD03	AC09	IO MIO#	AF10	IO HA23
C10	IO MD38	G01	IO GD20	N02	IO GD04	U26	IO HD02	AC10	IO HA27	AF11	IO HA21
C11	IO MD40	G02	IO GD22	N03	IO GD07	V01	IO HA28	AC11	IO HA28	AF12	IO HA22
C12	IO MD42	G03	IO GBE2#	N04	IO GD05	V02	IO AD25	AC12	IO HA17	AF13	IO HA20
C13	IO MD13	G04	IO GD17	N05	P AGND	V03	IO AD26	AC13	IO HA14	AF14	IO HA13
C14	IO MD47	G05	P GVCC	N09	P GND	V04	IO AD27	AC14	IO HA03	AF15	IO HA04
C15	IO MPD5	G22	O DS1#	N10	P GND	V05	P PVCC	AC15	IO HA07	AF16	IO HA09
C16	O SCASA#	G23	IO MD53	N11	P GND	V09	P GND	AC16	IO BE6#	AF17	IO BE4#
C17	O CAS5# / DOM5#	G24	IO MD21	N12	P GND	V13	P GND	AC17	IO BE1#	AF18	IO BE0#
C18	O SRASA#	G25	IO MD52	N13	P GND	V18	P GND	AC18	IO HD61	AF19	IO HD60
C19	O MA03	G26	IO MD20	N14	P GND	V22	P HVCC	AC19	IO HD57	AF20	IO HD56
C20	O MA07	H01	IO GD15	N15	P GND	V23	IO HD09	AC20	IO HD53	AF21	IO HD51
C21	O MA11	H02	IO GD18	N16	P GND	V24	IO HD08	AC21	IO HD48	AF22	IO HD47
C22	O MAA1	H03	IO GD19	N22	IO TA5	V25	IO HD07	AC22	IO HD44	AF23	IO HD43
C23	O RAS2# / CS2#	H04	IO GDS2#	N23	IO TA4	V26	IO HD06	AC23	IO HD31	AF24	IO HD40
C24	O SWEC# / MWEC#	H05	P GVCC	N24	IO TA3	W01	IO AD21	AC24	IO HD30	AF25	IO HD37
C25	O SWEB# / MWEB#	H22	O DS3#	N25	IO TA0	W02	IO AD22	AC25	IO HD29	AF26	IO HD35
C26	O SWEA# / MWEA#	H23	IO MD55	N26	IO TA1	W03	IO AD23	AC26	IO HD28		
D01	IO GD28	H24	IO MD23	P01	IO GD03	W04	IO CBE3#	AD01	IO AD13		

Figure 7. VT82C597AT Pin List (Alphabetical Order)

Pin #	Pin Name	Pin #	Pin Name	Pin #	Pin Name	Pin #	Pin Name	Pin #	Pin Name	Pin #	Pin Name
E21	P SVREF	AA02	IO FRAME#	P13	P GND	T22	IO HD01	A20	O MA05	D26	IO MPD2
AB08	P SVREF	M03	IO GBE0#	P14	P GND	U26	IO HD02	B20	O MA06	D24	IO MPD3
AE05	IO AD00	J04	IO GBE1#	P15	P GND	U25	IO HD03	C20	O MA07	A15	IO MPD4
AD05	IO AD01	G03	IO GBE2#	P16	P GND	U24	IO HD04	D20	O MA08	C15	IO MPD5
AC05	IO AD02	F01	IO GBE3#	P17	P GND	U23	IO HD05	A21	O MA09	D25	IO MPD6
AF04	IO AD03	D04	I GCLK	P18	P GND	V26	IO HD06	B21	O MA10	D23	IO MPD7
AE04	IO AD04	P03	IO GD00	P22	P GND	V25	IO HD07	C21	O MA11	E09	P MVCC
AD04	IO AD05	P02	IO GD01	R11	P GND	V24	IO HD08	D21	O MA12	E10	P MVCC
AF03	IO AD06	N01	IO GD02	R12	P GND	V23	IO HD09	A22	O MA13	E11	P MVCC
AE03	IO AD07	P01	IO GD03	R13	P GND	W26	IO HD10	B22	O MA10	E17	P MVCC
AF01	IO AD08	N02	IO GD04	R14	P GND	W25	IO HD11	C22	O MA11	E18	P MVCC
AE02	IO AD09	N04	IO GD05	R15	P GND	W24	IO HD12	D18	O MAB0	E19	P MVCC
AE01	IO AD10	M01	IO GD06	R16	P GND	W23	IO HD13	A19	O MAB1	J22	P MVCC
AD03	IO AD11	N03	IO GD07	R22	P GND	W22	IO HD14	A07	IO MD00	K22	P MVCC
AD02	IO AD12	M02	IO GD08	T11	P GND	Y26	IO HD15	C07	IO MD01	L22	P MVCC
AD01	IO AD13	L01	IO GD09	T12	P GND	Y25	IO HD16	B08	IO MD02	E20	P MVREF
AC04	IO AD14	L04	IO GD10	T13	P GND	Y24	IO HD17	D07	IO MD03	AD08	O NA#
AC03	IO AD15	L03	IO GD11	T14	P GND	Y23	IO HD18	B09	IO MD04	AC02	IO PAR
AA04	IO AD16	L02	IO GD12	T15	P GND	Y22	IO HD19	D09	IO MD05	W05	I PCLK
Y01	IO AD17	K01	IO GD13	T16	P GND	AA26	IO HD20	B10	IO MD06	AD06	O PGNT#
Y02	IO AD18	K04	IO GD14	U10	P GND	AA25	IO HD21	D10	IO MD07	AC06	I PREQ#
Y03	IO AD19	K02	IO GD15	U13	P GND	AA24	IO HD22	B11	IO MD08	R05	P PVCC
Y04	IO AD20	H01	IO GD16	U17	P GND	AA23	IO HD23	D11	IO MD09	T05	P PVCC
W01	IO AD21	G04	IO GD17	V09	P GND	AB26	IO HD24	B12	IO MD10	U05	P PVCC
W02	IO AD22	H02	IO GD18	V13	P GND	AB21	IO HD25	D12	IO MD11	V05	P PVCC
W03	IO AD23	H03	IO GD19	V18	P GND	AB24	IO HD26	A13	IO MD12	AB06	P PVCC
V01	IO AD24	G01	IO GD20	Y05	P GND	AB23	IO HD27	C13	IO MD13	AB07	P PVCC
V02	IO AD25	F03	IO GD21	AA05	P GND	AC26	IO HD28	E13	IO MD14	B24	O RAS0# / CS0#
V03	IO AD26	G02	IO GD22	AA22	P GND	AC25	IO HD29	B14	IO MD15	A24	O RAS1# / CS1#
V04	IO AD27	F04	IO GD23	AB13	P GND	AC24	IO HD30	E26	IO MD16	C23	O RAS2# / CS2#
U01	IO AD28	E01	IO GD24	AB14	P GND	AC23	IO HD31	E24	IO MD17	B23	O RAS3# / CS3#
U02	IO AD29	F02	IO GD25	AB22	P GND	AD26	IO HD32	F26	IO MD18	A23	O RAS4# / CS4#
U03	IO AD30	E02	IO GD26	T03	O GNT0#	AD25	IO HD33	F24	IO MD19	D22	O RAS5# / CS5#
U04	IO AD31	E04	IO GD27	R01	O GNT1#	AE26	IO HD34	G26	IO MD20	T02	I REQ0#
AD07	IO ADS#	D01	IO GD28	R03	O GNT2#	AF26	IO HD35	G24	IO MD21	T04	I REQ1#
M04	IO GDS0#	D03	IO GD29	P04	O GNT3#	AE25	IO HD36	H26	IO MD22	R02	I REQ2#
E03	IO GDS1#	D02	IO GD30	B06	IO GPAR	AF25	IO HD37	H24	IO MD23	R04	I REQ3#
N05	P AGND	C01	IO GD31	A03	I GPIPE#	AD24	IO HD38	J26	IO MD24	C06	- Reserved
AE09	O AHOLD	H04	IO GDSSEL#	B03	I GRBF#	AE24	IO HD39	J24	IO MD25	D06	- Reserved
K05	P AVCC	J03	IO GFRM#	A04	I GREQ#	AF24	IO HD40	K26	IO MD26	AC07	I RESET#
AF18	IO BE0#	B05	O GGNT#	A05	IO GSERR#	AD23	IO HD41	K24	IO MD27	A06	I SBA0
AC17	IO BE1#	J02	IO GIRDY#	K03	IO GSTOP#	AE23	IO HD42	L26	IO MD28	C03	I SBA1
AD17	IO BE2#	D08	P GND	J01	IO GTRDY#	AF23	IO HD43	L24	IO MD29	C05	I SBA2
AE17	IO BE3#	E06	P GND	H05	P GVCC	AC22	IO HD44	M26	IO MD30	A02	I SBA3
AF17	IO BE4#	E07	P GND	G05	P GVCC	AD22	IO HD45	M24	IO MD31	D05	I SBA4
AB16	IO BE5#	E14	P GND	J05	P GVCC	AE22	IO HD46	B07	IO MD32	A01	I SBA5
AC16	IO BE6#	E15	P GND	F05	P GVREF	AF22	IO HD47	A08	IO MD33	B01	I SBA6
AD16	IO BE7#	E16	P GND	T26	O GWE#	AC21	IO HD48	C08	IO MD34	C02	I SBA7
AE08	O BOFF#	E22	P GND	AC14	IO HA03	AD21	IO HD49	A09	IO MD35	B02	I SBS#
AC08	IO BRDY#	J09	P GND	AF15	IO HA04	AE21	IO HD50	C09	IO MD36	C16	O SCASA#
R23	O BWE#	J14	P GND	AE15	IO HA05	AF21	IO HD51	A10	IO MD37	B16	O SCASB#
AD09	I CACHE#	J18	P GND	AD15	IO HA06	AB20	IO HD52	C10	IO MD38	A16	O SCASC#
T25	O CADS#	K10	P GND	AC15	IO HA07	AC20	IO HD53	A11	IO MD39	AB04	IO SERR#
T24	O CADV#	K14	P GND	AB15	IO HA08	AD20	IO HD54	C11	IO MD40	AF08	I SMIACK#
A17	O CAS0# / DQM0#	K17	P GND	AF16	IO HA09	AE20	IO HD55	A12	IO MD41	C18	O SRASA#
D17	O CAS1# / DOM1#	L05	P GND	AE16	IO HA10	AF20	IO HD56	C12	IO MD42	B18	O SRASB#
A25	O CAS2# / DQM2#	L11	P GND	AD14	IO HA11	AC19	IO HD57	E12	IO MD43	A18	O SRASC#
A26	O CAS3# / DQM3#	L12	P GND	AE14	IO HA12	AD19	IO HD58	B13	IO MD44	C04	O ST0
B17	O CAS4# / DQM4#	L13	P GND	AF14	IO HA13	AE19	IO HD59	D13	IO MD45	B04	O ST1
C17	O CAS5# / DQM5#	L14	P GND	AC13	IO HA14	AF19	IO HD60	A14	IO MD46	E08	O ST2
B25	O CAS6# / DQM6#	L15	P GND	AD13	IO HA15	AC18	IO HD61	C14	IO MD47	AB01	IO STOP#
B26	O CAS7# / DQM7#	L16	P GND	AE13	IO HA16	AD18	IO HD62	E25	IO MD48	C26	O SWEA# / MWEA#
AF02	IO CBE0#	M05	P GND	AC12	IO HA17	AE18	IO HD63	E23	IO MD49	C25	O SWEB# / MWEB#
AC01	IO CBE1#	M11	P GND	AD12	IO HA18	AF07	I HITM#	F25	IO MD50	C24	O SWEC# / MWEC#
AA03	IO CBE2#	M12	P GND	AE12	IO HA19	AF05	I HLOCK#	F23	IO MD51	N25	IO TA0
W04	IO CBE3#	M13	P GND	AF13	IO HA20	U22	P HVCC	G25	IO MD52	N26	IO TA1
R24	O CCS1#	M14	P GND	AF11	IO HA21	V22	P HVCC	G23	IO MD53	M22	IO TA2
R25	O COE1#	M15	P GND	AF12	IO HA22	AB09	P HVCC	H25	IO MD54	N24	IO TA3
E05	P CVCC	M16	P GND	AF10	IO HA23	AB10	P HVCC	H23	IO MD55	N23	IO TA4
F22	P CVCC	N09	P GND	AE10	IO HA24	AB17	P HVCC	J25	IO MD56	N22	IO TA5
AB05	P CVCC	N10	P GND	AB11	IO HA25	AB18	P HVCC	J23	IO MD57	P25	IO TA6
AB21	P CVCC	N11	P GND	AD10	IO HA26	AB19	P HVCC	K25	IO MD58	P26	IO TA7
AE07	IO D/C#	N12	P GND	AC10	IO HA27	AA01	IO IRDY#	K23	IO MD59	P23	IO TA8
AB02	IO DEVSEL#	N13	P GND	AC11	IO HA28	AF09	O KEN#	L25	IO MD60	R26	IO TA9
D15	O DS0#	N14	P GND	AD11	IO HA29	T01	IO LOCK#	L23	IO MD61	AB03	IO TRDY#
G22	O DS1#	N15	P GND	AB12	IO HA30	AC09	IO M/IO#	M25	IO MD62	P24	O TWE#
D16	O DS2#	N16	P GND	AE11	IO HA31	B19	O MA02	M23	IO MD63	AF06	IO W/R#
H22	O DS3#	P11	P GND	P05	I HCLK	C19	O MA03	D14	IO MPD0		
AE06	O EADS#	P12	P GND	T23	IO HD00	D19	O MA04	B15	IO MPD1		

Table 1. VT82C597 / VT82C597AT Pin Descriptions

CPU Interface				
Signal Name	597 Pin #	597AT Pin #	I/O	Signal Description
ADS#	AD7	AD7	B	Address Strobe. The CPU asserts ADS# in T1 of the CPU bus cycle to initiate a command
M/IO#	AC9	AC9	B	Memory / IO Command Indicator
W/R#	AF6	AF6	B	Write / Read Command Indicator
D/C#	AE7	AE7	B	Data / Control Command Indicator
BRDY#	AC8	AC8	B	Bus Ready. The VT82C597 asserts BRDY# to indicate to the CPU that data is available on reads or has been received on writes.
EADS#	AE6	AE6	O	External Address Strobe. Asserted by the VT82C597 to inquire the L1 cache when serving PCI master accesses to main memory.
KEN# / INV	AF9	AF9	O	Cache Enable / Invalidate. KEN# / INV functions as both the KEN# signal during CPU read cycles and the INV signal during L1 cache snoop cycles.
HITM#	AF7	AF7	I	Hit Modified. Asserted by the CPU to indicate that the address presented with the last assertion of EADS# is modified in the L1 cache and needs to be written back.
HLOCK#	AF5	AF5	I	Host Lock. All CPU cycles sampled with the assertion of HLOCK# and ADS# until the negation of HLOCK# must be atomic.
CACHE#	AD9	AD9	I	Cacheable Indicator. Asserted by the CPU during a read cycle to indicate the CPU can perform a burst line fill. Asserted by the CPU during a write cycle to indicate that the CPU will perform a burst write-back cycle.
AHOLD	AE9	AE9	O	Address Hold. The VT82C597 asserts AHOLD when a PCI master is accessing main memory. AHOLD is held for the duration of the PCI burst transfer.
NA#	AD8	AD8	O	Next Address Indicator.
BOFF#	AE8	AE8	O	Back Off. Asserted by the VT82C597 when required to terminate a CPU cycle that was in progress.
SMIACT#	AF8	AF8	I	System Management Interrupt Active. This is asserted by the CPU when it is in system management mode as a result of SMI.
BE[7:0]#	AD16, AC16, AB16, AF17, AE17, AD17, AC17, AF18	AD16, AC16, AB16, AF17, AE17, AD17, AC17, AF18	B	Byte Enables. The CPU byte enables indicate which byte lane the current CPU cycle is accessing.
HA[31:3]	(see pinout tables)	(see pinout tables)	B	Host Address Bus. HA[31:3] connect to the address bus of the host CPU. During CPU cycles HA[31:3] are inputs. These signals are driven by the VT82C597 during cache snooping operations.
HD[63:0]	(see pinout tables)	(see pinout tables)	B	Host CPU Data. These signals are connected to the CPU data bus.

Note: Clocking of the CPU and cache interfaces is performed with HCLK; see the clock pin group at the end of the pin descriptions section for descriptions of the clock input pins.

Cache Control				
Signal Name	597 Pin #	597AT Pin #	I/O	Signal Description
CADS#	T25	T25	O	Cache Address Strobe. Assertion causes the burst SRAM to load the address register from address pins. Connected to all cache SRAMs.
CADV#	T24	T24	O	Cache Advance. Assertion causes the burst SRAM to advance to the next Quadword in the cache line. Connected to all cache SRAMs.
COE1#	R25	R25	O	Cache Output Enable. Typically connected to all cache SRAMs.
CCS1#	R24	R24	O	Cache Chip Select. Typically connected to all cache SRAMs.
TA[9:0]	R26, P23, P26, P25, N22, N23, N24, M26, N26, N25	R26, P23, P26, P25, N22, N23, N24, M26, N26, N25	B	Tag Address. TA0-9 are inputs during CPU accesses and outputs during L2 cache line fills and L2 line invalidates during inquire cycles.
TWE#	P24	P24	O	Tag Write Enable. When asserted, new state and tag addresses are written into the external tag. Connected to all cache SRAMs.
GWE#	T26	T26	O	Global Write Enable. Connected to all cache SRAMs.
BWE#	R23	R23	O	Byte Write Enable. Connected to all cache SRAMs.

Note: Only Pipeline Burst SRAMs are supported for cache.

Note: The VT82C597 pinouts were defined assuming the ATX PCB layout model shown below (and general pin layout shown) as a guide for PCB component placement. Other PCB layouts (AT, LPX, and NLX) were also considered and can typically follow the same general component placement. For PCB layouts that require different component placements from that shown below (i.e., for component placements that don't allow optimal layouts using the VT82C597), the VT82C597AT alternate pinout is available.

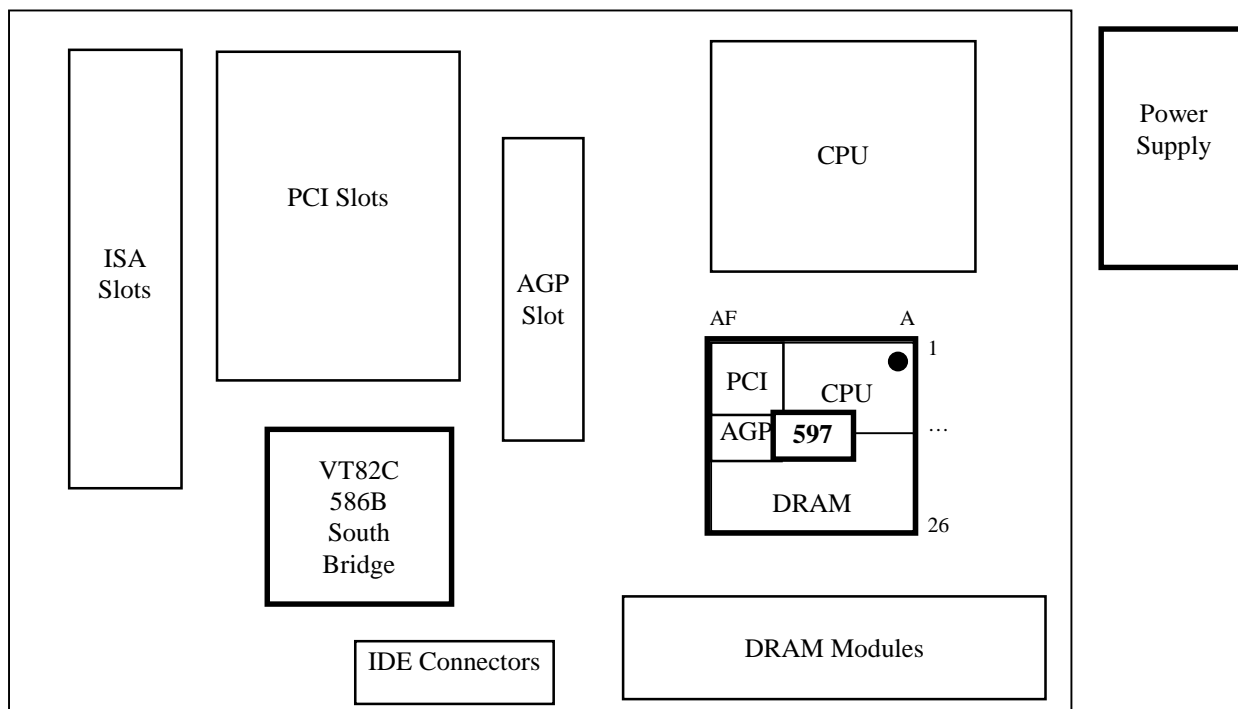

DRAM Interface				
Signal Name	597 Pin #		I/O	Signal Description
MD[63:0]	(see pinout tables)	(see pinout tables)	B	Memory Data. These signals are connected to the DRAM data bus. Note: MD0 is internally pulled up for use in EDO memory type detection.
MPD[7:0]	H4, L4, W4, Y4, J4, K4, W5, AA4	D23, D25, C15, A15, D24, D26, B15, D14	B	DRAM ECC or EC Data
MA[13:2], MAA[1:0], MAB[1:0]	N2, N1, P3, P2, P1, N4, R3, R2, R1, P4, T3, T2, M1, N3, T1, R4	A22, D21, C21, B21, A21, D20, C20, B20, A20, D19, C19, B19, C22, B22, A19, D18	O	Memory Address. DRAM address lines.
RAS#[5:0] / CS#[5:0]	M2, M3, L1, M4, L2, L3	D22, A23, B23, C23, A24, B24	O	Multifunction Pins 1. FPG/EDO DRAM: Row Address Strobe of each bank. 2. Synchronous DRAM: Chip select of each bank.
CAS#[7:0] / DQM#[7:0]	J1, V3, K2, V2, K3, T4, K1, V1	B26, B25, C17, B17, A26, A25, D17, A17	O	Multifunction Pins 1. FPG/EDO DRAM: Column Address Strobe of each byte lane. 2. Synchronous DRAM: Data mask of each byte lane.
SRASA#, SRASB#, SRASC#	U3, U2, U1	C18, B18, A18	O	Row Address Command Indicator. For support of up to three Synchronous DRAM DIMM slots (these are not copies as each DIMM slot may have separate timing). "A" controls banks 0-1 (module 0), "B" controls banks 2-3 (module 1), and "C" controls banks 4-5 (module 2).
SCASA#, SCASB#, SCASC#	W3, W2, W1	C16, B16, A16	O	Column Address Command Indicator. For support of up to three Synchronous DRAM DIMM slots (these are not copies as each DIMM slot may have separate timing). "A" controls banks 0-1 (module 0), "B" controls banks 2-3 (module 1), and "C" controls banks 4-5 (module 2).
SWEA# / MWEA#, SWEB# / MWEB#, SWEC# / MVEC#	J2, J3, H1	C26, C25, C24	O	Write Enable Command Indicator. For support of up to three Synchronous DRAM DIMM slots (these are not copies as each DIMM slot may have separate timing). Multifunction pins, used as MWE# pins for FPG/EDO memory. "A" controls banks 0-1 (module 0), "B" controls banks 2-3 (module 1), and "C" controls banks 4-5 (module 2).
DS[3:0]#	E4, V4, F4, U4	H22, D16, G22, D15	O	SDRAM-II Data Strobes. Every 16 data bits share one common data strobe. I.e., DS0# corresponds to MD[15:0], DS1# corresponds to MD[31:16], etc.

Note: Clocking of the memory subsystem is synchronous with the CPU clock (HCLK); see the clock pin group at the end of the pin descriptions section for descriptions of the clock input pins.

PCI Bus Interface				
Signal Name	597 Pin #	597AT Pin #	I/O	Signal Description
FRAME#	L25	AA2	B	Frame. Assertion indicates the address phase of a PCI transfer. Negation indicates that one more data transfer is desired by the cycle initiator.
AD[31:0]	(see pinout tables)	(see pinout tables)	B	Address/Data Bus. The standard PCI address and data lines. The address is driven with FRAME# assertion and data is driven or received in following cycles.
CBE[3:0]#	B26, C23, J25, K23	W4, AA3, AC1, AF2	B	Command/Byte Enable. Commands are driven with FRAME# assertion. Byte enables corresponding to supplied or requested data are driven on following clocks.
IRDY#	K26	AA1	B	Initiator Ready. Asserted when the initiator is ready for data transfer.
TRDY#	K25	AB3	B	Target Ready. Asserted when the target is ready for data transfer.
STOP#	A22	AB1	B	Stop. Asserted by the target to request the master to stop the current transaction.
DEVSEL#	J26	AB2	B	Device Select. This signal is driven by the VT82C597 when a PCI initiator is attempting to access main memory. It is an input when the VT82C597 is acting as a PCI initiator.
PAR	D20	AC2	B	Parity. A single parity bit is provided over AD[31:0] and C/BE[3:0].
SERR#	C22	AB4	B	System Error. VT82C597 will pulse this signal when it detects a system error condition.
LOCK#	B22	T1	B	Lock. Used to establish, maintain, and release resource lock.
PREQ#	M24	AC6	I	PCI Request. This signal comes from the South Bridge. PREQ# is the South Bridge request for the PCI bus.
PGNT#	L26	AD6	O	PCI Grant. This signal driven by the VT82C597 to grant PCI access to the South Bridge.
REQ[3:0]#	H24, G25, F26, F24	R4, R2, T4, T2	I	Request. PCI master requests for PCI.
GNT[3:0]#	H25, G26, G24, F25	P4, R3, R1, T3	O	Grant. Permission is given to the master to use PCI.

Note: Clocking of the PCI interface is performed with PCLK; see the clock pin group at the end of the pin descriptions section for descriptions of the clock input pins.

AGP Bus Interface				
Signal Name	597 Pin #	597AT Pin #	I/O	Signal Description
GFRM#	B12	J3	B	Frame (PCI transactions only). Assertion indicates the address phase of a PCI transfer. Negation indicates that one more data transfer is desired by the cycle initiator.
GDS0#	B8	M4	B	Bus Strobe 0 (AGP transactions only). Provides timing for 2x data transfer mode on AD[15:0]. The agent that is providing the data drives this signal.
GDS1#	D14	E3	B	Bus Strobe 1 (AGP transactions only). Provides timing for 2x data transfer mode on AD[31:16]. The agent that is providing the data drives this signal.
GD[31:0]	(see pinout tables)	(see pinout tables)	B	Address/Data Bus. The standard AGP/PCI address and data lines. The address is driven with GDS0# and GDS1# assertion for AGP transfers and is driven with GFRM# assertion for PCI transfers.
GBE[3:0]#	B14, D11, A10, A8	F1, G3, J4, M3	B	Command/Byte Enable. AGP: These pins provide command information (different commands than for PCI) driven by the master (graphics controller) when requests are being enqueued using PIPE#. These pins provide valid byte information during AGP write transactions and are driven by the master. The target (this chip) drives these lines to "0000" during the return of AGP read data, but the state of these pins is ignored by the AGP master. PCI: Commands are driven with GFRM# assertion. Byte enables corresponding to supplied or requested data are driven on following clocks.
GIRDY#	C12	J2	B	Initiator Ready AGP: For write operations, the assertion of this pin indicates that the master is ready to provide <i>all</i> write data for the current transaction. Once this pin is asserted, the master is not allowed to insert wait states. For read operations, the assertion of this pin indicates that the master is ready to transfer a subsequent block of read data. The master is <i>never</i> allowed to insert a wait state during the initial block of a read transaction. However, it may insert wait states after each block transfers. PCI: Asserted when the initiator is ready for data transfer.
GTRDY#	A11	J1	B	Target Ready: AGP: Indicates that the target is ready to provide read data for the entire transaction (when the transaction can complete within four clocks) or is ready to transfer a (initial or subsequent) block of data when the transfer requires more than four clocks to complete. The target is allowed to insert wait states after each block transfers on both read and write transactions. PCI: Asserted when the target is ready for data transfer.
GSTOP#	C11	K3	B	Stop (PCI transactions only). Asserted by the target to request the master to stop the current transaction.
GDSEL#	B11	H4	B	Device Select (PCI transactions only). This signal is driven by the VT82C597 when a PCI initiator is attempting to access main memory. It is an input when the VT82C597 is acting as PCI initiator. Not used for AGP cycles.

Note: Clocking of the AGP interface is performed with GCLK; see the clock pin group for descriptions of the clock input pins.

Note: PCB Layout Guidelines (reference from AGP specification)

- Total motherboard trace length 10" max, trace impedance = 65 ohms \pm 15 ohms, minimize signal crosstalk
- Trace lengths within groups matched to within 2 inches or better
 Groups are:
 - GDS0#, GD15-0, GBE1-0#
 - GDS1#, GD31-16, GBE3-2#
 - SBS#, SBA7-0
- Ground isolation should be provided around GDS0# and GDS1# to prevent crosstalk with GD[31:0]. Ideally ground traces should be provided adjacent to GDSn# on the same signal layer, but at a minimum wider spaces should be provided on either side (e.g., 16 mil spaces on either side of GDSn# if GDSn# signal traces are 8 mil).

AGP Bus Interface (continued)				
Signal Name	597 Pin #	597AT Pin #	I/O	Signal Description
GPIPE#	B19	A3	I	Pipelined Request (AGP only). Asserted by the master (graphics controller) to indicate that a full-width request is to be enqueued by the target (VT82C597). The master enqueues one request each rising edge of GCLK while PIPE# is asserted. When PIPE# is deasserted no new requests are enqueued across the AD bus.
GRBF#	C19	B3	I	Read Buffer Full (AGP only). Indicates if the master (graphics controller) is ready to accept previously requested low priority read data or not. When RBF# is asserted, the VT82C597 will not return low priority read data to the master.
SBA[7:0]	C17, D16, A17, B17, B18, D17, A18, D18	C2, B1, A1, D5, A2, C5, C3, A6	I	SideBand Address (AGP only). Provides an additional bus to pass address and command information from the master (graphics controller) to the target (the VT82C597). These pins are ignored until enabled.
SBS#	C18	B2	I	Sideband Strobe (AGP only). Provides timing for SBA[7:0] and is driven by the master.
ST[2:0]	D21, B20, A19	E8, B4, C4	O	Status (AGP only). Provides information from the arbiter to a master to indicate what it may do. Only valid while GGNT# is asserted. 000 Indicates that previously requested low priority read or flush data is being returned to the master (graphics controller). 001 Indicates that previously requested high priority read data is being returned to the master. 010 Indicates that the master is to provide low priority write data for a previously enqueued write command. 011 Indicates that the master is to provide high priority write data for a previously enqueued write command. 100 Reserved. (Arbiter must not issue. May be defined in the future). 101 Reserved. (Arbiter must not issue. May be defined in the future). 110 Reserved. (Arbiter must not issue. May be defined in the future). 111 Indicates that the master (graphics controller) has been given permission to start a bus transaction. The master may enqueue AGP requests by asserting PIPE# or start a PCI transaction by asserting GFRM#. ST[2:0] are always outputs from the VT82C597 and inputs to the master.
GREQ#	A20	A4	I	Request. Master request for AGP.
GGNT#	B21	B5	O	Grant. Permission is given to the master to use AGP.
GPAR	A21	B6	B	Parity. A single parity bit is provided over GD[31:0] and GBE[3:0].
GSERR#	C20	A5	B	System Error. VT82C597 will pulse this signal when it detects a system error condition.
-reserved-	C21	C6	-	Reserved. Do not connect. Reserved for future use.
-reserved-	E20	D6	-	Reserved. Do not connect. Reserved for future use.

Note: For PCI operation on the AGP bus, the following pins are not required:

- PERR# (parity and error reporting not required on transient data devices such as graphics controllers)
- LOCK# (no lock requirement on AGP)
- IDSEL (internally connected to AD16 on AGP-compliant masters)

Note: Separate system interrupts are not provided for AGP. The AGP connector provides interrupts via PCI bus INTA-B#.

Note: The AGP bus supports only one master directly (REQ[3:0]# and GNT[3:0]# are not provided). External logic is required to implement additional master capability. Note that the arbitration mechanism on the AGP bus is different from the PCI bus.

Note: A separate reset is not required for the AGP bus (RESET# resets both PCI and AGP buses)

Note: Two mechanisms are provided by the AGP bus to enqueue master requests: PIPE# (to send addresses multiplexed on the AD lines) and the SBA port (to send addresses unmultiplexed). AGP masters implement one or the other or select one at initialization time (they are not allowed to change during runtime). Therefore only one of the two will be used and the signals associated with the other will not be used. Therefore the 82C597 has an internal pullup on RBF# to maintain it in the de-asserted state in case it is not implemented on the master device.

Clock / Reset Control																
<u>Signal Name</u>	<u>597 Pin #</u>	<u>597AT Pin #</u>	<u>I/O</u>	<u>Signal Description</u>												
HCLK	N5	P5	I	Host Clock. This pin receives a buffered host clock. This clock is used by all of the VT82C597 logic that is in the host CPU and memory clock domains. This should be the same clock net that is delivered to the CPU.												
GCLK / GND	E8	D4	I	AGP Clock. <u>This pin is provided for test purposes and should be connected to ground.</u>												
PCLK	D19	W5	I	<p>PCI Clock. This pin receives a buffered divided-by-2 host clock. This clock is used by all of the VT82C597 logic that is in the PCI clock domain. This clock input must be 33 MHz maximum to comply with PCI specification requirements and must be synchronous with HCLK with an HCLK:PCLK frequency ratio of 2:1.</p> <p><u>Typical Clock Frequency Combinations</u></p> <table border="1" style="margin-left: 40px;"> <thead> <tr> <th><u>Mode</u></th> <th><u>Host Clock</u></th> <th><u>AGP Clock</u></th> <th><u>PCI Clock</u></th> </tr> </thead> <tbody> <tr> <td>2x</td> <td>60 MHz</td> <td>60 MHz</td> <td>30 MHz</td> </tr> <tr> <td>2x</td> <td>66 MHz</td> <td>66 MHz</td> <td>33 MHz</td> </tr> </tbody> </table>	<u>Mode</u>	<u>Host Clock</u>	<u>AGP Clock</u>	<u>PCI Clock</u>	2x	60 MHz	60 MHz	30 MHz	2x	66 MHz	66 MHz	33 MHz
<u>Mode</u>	<u>Host Clock</u>	<u>AGP Clock</u>	<u>PCI Clock</u>													
2x	60 MHz	60 MHz	30 MHz													
2x	66 MHz	66 MHz	33 MHz													
RESET#	M25	AC7	I	Reset. When asserted, this signal resets the VT82C597 and sets all register bits to the default value. This signal also connects to the PCI bus, to the AGP bus, and (through an inverter) to the ISA bus (if implemented).												

Power and Ground				
Signal Name	597 Pin #	597AT Pin #	I/O	Signal Description
CVCC	E5, F22, AB5, AB21	E5, F22, AB5, AB21	P	Power for internal logic (3.3V ±5%).
HVCC	U22, V22, AB9, AB10, AB17, AB18, AB19	U22, V22, AB9, AB10, AB17, AB18, AB19	P	Power for CPU interface (2.5V to 3.3V ±5%).
MVCC	G5, H5, J5, R5, T5, U5, V5, AB6, AB7	E9, E10, E11, E17, E18, E19, J22, K22, L22	P	Power for Memory interface (3.3V ±5%).
PVCC	J22, K22, L22	R5, T5, U5, V5, AB6, AB7	P	Power for PCI interface (3.3V ±5%).
GVCC	E9, E10, E11, E17, E18, E19	G5, H5, J5	P	Power for AGP interface (3.3V ±5%).
AVCC	F5	K5	P	Analog Power (3.3V ±5%). For internal clock logic.
AGND	K5	N5	P	Analog Ground. For internal clock logic. Connect to main ground plane.
GND	D8, E6-E7, E14-E16, E22, J9, J14, J18, K10, K14, K17, L5, L11-L16, M5, M11-M16, N9-N16, P11-P18, P22, R11-R16, R22, T11-T16, U10, U13, U17, V9, V13, V18, Y5, AA5, AA22, AB13, AB14, AB22	D8, E6-E7, E14-E16, E22, J9, J14, J18, K10, K14, K17, L5, L11-L16, M5, M11-M16, N9-N16, P11-P18, P22, R11-R16, R22, T11-T16, U10, U13, U17, V9, V13, V18, Y5, AA5, AA22, AB13, AB14, AB22	P	Ground
5VREF	E21, AB8	E21, AB8	P	5V Reference (5V ±5%). Used to provide 5V input tolerance.
GVREF	E13	F5	P	AGP Voltage Reference. 0.39 GVCC to 0.41 GVCC. Typical value is 1.32V (0.40 times 3.3V). This can be provided with a resistive divider on GVCC using 270 ohm and 180 ohm (2%) resistors.
MVREF	P5	E20	P	DRAM Voltage Reference. 1.5V for SDRAM, 1.0V for SDRAM-II (±5%)

REGISTERS

Register Overview

The following tables summarize the configuration and I/O registers of the VT82C597. These tables also document the power-on default value (“Default”) and access type (“Acc”) for each register. Access type definitions used are RW (Read/Write), RO (Read/Only), “—” for reserved / used (essentially the same as RO), and RWC (or just WC) (Read / Write 1’s to Clear individual bits). Registers indicated as RW may have some read/only bits that always read back a fixed value (usually 0 if unused); registers designated as RWC or WC may have some read-only or read write bits (see individual register descriptions for details).

Detailed register descriptions are provided in the following section of this document. All offset and default values are shown in hexadecimal unless otherwise indicated.

Table 2. VT82C597 Registers

VT82C597 Device 0 Registers - Host Bridge

Header Registers

Offset	Configuration Space Header	Default	Acc
1-0	Vendor ID	1106	RO
3-2	Device ID	0597	RO
5-4	Command	0006	RW
7-6	Status	0290	WC
8	Revision ID	nn	RO
9	Program Interface	00	RO
A	Sub Class Code	00	RO
B	Base Class Code	06	RO
C	-reserved- (cache line size)	00	—
D	Latency Timer	00	RW
E	Header Type	00	RO
F	Built In Self Test (BIST)	00	RO
13-10	Graphics Aperture Base	0000 0008	RW
14-27	-reserved- (base address registers)	00	—
28-2F	-reserved- (unassigned)	00	—
33-30	-reserved- (expan ROM base addr)	00	—
37-34	Capability Pointer	0000 00A0	RO
34-3B	-reserved- (unassigned)	00	—
3C-3D	-reserved- (interrupt line & pin)	00	—
3E-3F	-reserved- (min gnt and max latency)	00	—

Device-Specific Registers

Offset	Cache Control	Default	Acc
50	Cache Control 1	00	RW
51	Cache Control 2	00	RW
52	Non-Cacheable Control	00	RW
53	System Performance Control	00	RW
55-54	Non-Cacheable Region #1	0000	RW
57-56	Non-Cacheable Region #2	0000	RW

Offset	DRAM Control	Default	Acc
59-58	MA Map Type	0000	RW
5A-5F	DRAM Row Ending Address:		
5A	Bank 0 Ending (HA[29:22])	01	RW
5B	Bank 1 Ending (HA[29:22])	01	RW
5C	Bank 2 Ending (HA[29:22])	01	RW
5D	Bank 3 Ending (HA[29:22])	01	RW
5E	Bank 4 Ending (HA[29:22])	01	RW
5F	Bank 5 Ending (HA[29:22])	01	RW
60	DRAM Type	00	RW
61	ROM Shadow Control C0000-CFFFF	00	RW
62	ROM Shadow Control D0000-DFFFF	00	RW
63	ROM Shadow Control E0000-FFFFF	00	RW
64	DRAM Timing for Banks 0,1	EC	RW
65	DRAM Timing for Banks 2,3	EC	RW
66	DRAM Timing for Banks 4,5	EC	RW
67	-reserved- (unassigned)	00	RW
68	DRAM Control	00	RW
69	-reserved- (unassigned)	00	RW
6A	DRAM Refresh Counter	00	RW
6B	DRAM Arbitration Control	01	RW
6C	SDRAM Control	00	RW
6D	DRAM Control Drive Strength	00	RW
6E	ECC Control	00	RW
6F	ECC Status	00	RO

Offset	PCI Bus Control	Default	Acc
70	PCI Buffer Control	00	RW
71	CPU to PCI Flow Control 1	00	RW
72	CPU to PCI Flow Control 2	00	RW
73	PCI Master Control 1	00	RW
74	PCI Master Control 2	00	RW
75	PCI Arbitration 1	00	RW
76	PCI Arbitration 2	00	RW
77	Chip Test (do not program)	00	RW
78-7D	-reserved-	00	—
7E	DLL Test Mode (do not program)	00	RW
7F	DLL4 Test Mode (do not program)	00	RW
80-FF	-reserved-	00	—

Offset	GART/TLB Control	Default	Acc
83-80	GART/TLB Control	0000 0000	RW
84	Graphics Aperture Size	00	RW
85-87	-reserved- (unassigned)	00	—
8B-88	Gr. Aperture Translation Table Base	0000 0000	RW
8C-8F	-reserved- (unassigned)	00	—

Offset	AGP Control	Default	Acc
A0	AGP ID	02	RO
A1	AGP Next Item Pointer	00	RO
A2	AGP Specification Revision	10	RO
A3	-reserved- (unassigned)	00	—
A7-A4	AGP Status	0700 0203	RO
AB-A8	AGP Command	0000 0000	RW
AC-AE	-reserved- (unassigned)	00	—
AF	AGP Control	00	RW

VT82C597 Device 1 - PCI-to-PCI Bridge
Header Registers

Offset	Configuration Space Header	Default	Acc
1-0	Vendor ID	1106	RO
3-2	Device ID	8597	RO
5-4	Command	0007	RW
7-6	Status	0220	WC
8	Revision ID	nn	RO
9	Program Interface	00	RO
A	Sub Class Code	04	RO
B	Base Class Code	06	RO
C	-reserved- (cache line size)	00	—
D	Latency Timer	00	RW
E	Header Type	01	RO
F	Built In Self Test (BIST)	00	RO
10-17	-reserved- (base address registers)	00	—
18	Primary Bus Number	00	RW
19	Secondary Bus Number	00	RW
1A	Subordinate Bus Number	00	RW
1B	-reserved- (secondary latency timer)	00	—
1C	I/O Base	F0	RW
1D	I/O Limit	00	RW
1F-1E	Secondary Status	0000	RO
21-20	Memory Base	FFF0	RW
23-22	Memory Limit (Inclusive)	0000	RW
25-24	Prefetchable Memory Base	FFF0	RW
27-26	Prefetchable Memory Limit	0000	RW
28-3D	-reserved- (unassigned)	00	—
3F-3E	PCI-to-PCI Bridge Control	00	RW

Device-Specific Registers

Offset	PCI Bus #2 Control	Default	Acc
40	CPU-to-PCI Flow Control 1	00	RW
41	CPU-to-PCI Flow Control 2	00	RW
42	PCI Master Control	00	RW
43-4F	-reserved- (unassigned)	00	—

Configuration Space I/O

All registers in the VT82C597 (listed above) are addressed via the following configuration mechanism:

Mechanism #1

These ports respond only to double-word accesses. Byte or word accesses will be passed on unchanged.

Port CFB-CF8 - Configuration Address..... RW
31 Configuration Space Enable

- 0 Disabled..... default
- 1 Convert configuration data port writes to configuration cycles on the PCI bus

30-24 Reserved always reads 0
23-16 PCI Bus Number

Used to choose a specific PCI bus in the system

15-11 Device Number

Used to choose a specific device in the system (devices 0 and 1 are defined for the VT82C597)

10-8 Function Number

Used to choose a specific function if the selected device supports multiple functions (only function 0 is defined for the VT82C597).

7-2 Register Number (also called the "Offset")

Used to select a specific DWORD in the VT82C597 configuration space

1-0 Fixed always reads 0
Port CFF-CFC - Configuration Data..... RW

Refer to PCI Bus Specification Version 2.1 for further details on operation of the above configuration registers.

Register Descriptions

Device 0 Header Registers - Host Bridge

All registers are located in PCI configuration space. They should be programmed using PCI configuration mechanism 1 through CF8 / CFC with bus number, function number, and device number equal to zero.

Device 0 Offset 1-0 - Vendor ID.....RO

15-0 ID Code (reads 1106h to identify VIA Technologies)

Device 0 Offset 3-2 - Device ID.....RO

15-0 ID Code (reads 0597h to identify the VT82C597)

Device 0 Offset 5-4 - Command.....RW

15-10 Reserved always reads 0

9 Fast Back-to-Back Cycle Enable RW

0 Fast back-to-back transactions only allowed to the same agentdefault

1 Fast back-to-back transactions allowed to different agents

8 SERR# Enable..... RO

0 SERR# driver disableddefault

1 SERR# driver enabled

(SERR# is used to report parity errors if bit-6 is set).

7 Address / Data Stepping RO

0 Device never does steppingdefault

1 Device always does stepping

6 Parity Error Response..... RW

0 Ignore parity errors & continuedefault

1 Take normal action on detected parity errors

5 VGA Palette Snoop RO

0 Treat palette accesses normallydefault

1 Don't respond to palette accesses on PCI bus

4 Memory Write and Invalidate Command..... RO

0 Bus masters must use Mem Writedefault

1 Bus masters may generate Mem Write & Inval

3 Special Cycle Monitoring RO

0 Does not monitor special cyclesdefault

1 Monitors special cycles

2 Bus Master RO

0 Never behaves as a bus master

1 Can behave as a bus masterdefault

1 Memory Space..... RO

0 Does not respond to memory space

1 Responds to memory spacedefault

0 I/O Space RO

0 Does not respond to I/O spacedefault

1 Responds to I/O space

Device 0 Offset 7-6 - Status..... RWC

15 Detected Parity Error

0 No parity error detected default

1 Error detected in either address or data phase.

This bit is set even if error response is disabled (command register bit-6).write one to clear

14 Signaled System Error (SERR# Asserted)

.....always reads 0

13 Signaled Master Abort

0 No abort received default

1 Transaction aborted by the master

.....write one to clear

12 Received Target Abort

0 No abort received default

1 Transaction aborted by the target.....

..... write 1 to clear

11 Signaled Target Abort..... always reads 0

0 Target Abort never signaled

10-9 DEVSEL# Timing

00 Fast

01 Medium..... always reads 01

10 Slow

11 Reserved

8 Data Parity Error Detected

0 No data parity error detected default

1 Error detected in data phase. Set only if error response enabled via command bit-6 = 1 and VT82C597 was initiator of the operation in

which the error occurred.write one to clear

7 Fast Back-to-Back Capable always reads 1

6 Reserved always reads 0

5 66MHz Capable..... always reads 0

4 Supports New Capability list..... always reads 1

3-0 Reserved always reads 0

Device 0 Offset 8 - Revision ID..... RO

7-0 VT82C597 Chip Revision Code

00 First Silicon (Revision "A")

01 Production Silicon (Revision "B")

Device 0 Offset 9 - Programming Interface..... RO

7-0 Interface Identifier always reads 00

Device 0 Offset A - Sub Class Code..... RO

7-0 Sub Class Codereads 00 to indicate Host Bridge

Device 0 Offset B - Base Class Code..... RO

7-0 Base Class Code ..reads 06 to indicate Bridge Device

Device 0 Offset D - Latency Timer RW

Specifies the latency timer value in PCI bus clocks.

7-3 Guaranteed Time Slice for CPU..... default=0

2-0 Reserved (fixed granularity of 8 clks) .always reads 0

Bits 2-1 are writeable but read 0 for PCI specification compatibility. The programmed value may be read back in Offset 75 bits 5-4 (PCI Arbitration 1).

Device 0 Host Bridge Header Registers (continued)

Device 0 Offset E - Header Type.....RO

7-0 Header Type Codereads 00: single function

Device 0 Offset F - Built In Self Test (BIST).....RO

- 7 BIST Supportedreads 0: no supported functions
- 6 Start Testwrite 1 to start but writes ignored
- 5-4 Reservedalways reads 0
- 3-0 Response Code..... 0 = test completed successfully

Device 0 Offset 13-10 - Graphics Aperture BaseRW

31-28 Upper Programmable Base Address Bits..... def=0

27-20 Lower Programmable Base Address Bits def=0

These bits behave as if hardwired to 0 if the corresponding Graphics Aperture Size register bit (Device 1 Offset 84h) is 0.

27	26	25	24	23	22	21	20	(This Register)
<u>7</u>	<u>6</u>	<u>5</u>	<u>4</u>	<u>3</u>	<u>2</u>	<u>1</u>	<u>0</u>	(Gr Aper Size)
RW	RW	RW	RW	RW	RW	RW	RW	1M
RW	RW	RW	RW	RW	RW	RW	0	2M
RW	RW	RW	RW	RW	RW	0	0	4M
RW	RW	RW	RW	RW	0	0	0	8M
RW	RW	RW	RW	0	0	0	0	16M
RW	RW	RW	0	0	0	0	0	32M
RW	RW	0	0	0	0	0	0	64M
RW	0	0	0	0	0	0	0	128M
0	0	0	0	0	0	0	0	256M

19-0 Reservedalways reads 00008

Note: The locations in the address range defined by this register are prefetchable.

Device 0 Offset 37-34 - Capability Pointer.....RO

Contains an offset from the start of configuration space.

31-0 AGP Capability List Pointeralways reads A0h

Device 0 Configuration Registers - Host Bridge

This group of registers is pointed to by the value in offset 34.

Cache Control

Device 0 Offset 50 - Cache Control 1.....RW

- 7-6 Cache Enable / Initialize**
 - 00 Cache disabledefault
 - 01 Cache Initialize - always does L2 fill
 - 10 Cache enable (normal operation)
 - 11 Reserved (do not use)
- 5 Linear Burst**
 - 0 Disabledefault
 - 1 Enable
- 4-3 Tag Configuration**
 - 00 8+0 - 8 Tag bits, no alt (dirty) bitdefault
 - 01 7+1 - 7 Tag bits + alternate (dirty) bit
 - 10 10+0 - 10 Tag bits, no alternate (dirty) bit
 - 11 9+1 - 9 Tag bits + alternate (dirty) bit
- 2-0 Reserved**always read 0

Device 0 Offset 51 - Cache Control 2.....RW

- 7-6 Reserved (no function)..... RW**
- 5 Backoff CPU**
Set to one to backoff CPU when non-streaming access to fill L2 cache. Used when register 52h bit-2 is set for "L2 fill when CACHE# is inactive". This bit should normally be set to 0 for best performance, but performance differences are typically not significantly noticeable at the system level.
 - 0 Defer ready return until L2 is filleddefault
 - 1 Backoff CPU until L2 is filled
- 4 Reserved** always reads 0
- 3 SRAM Banks**(default set from inverse of HA29)
 - 0 1 Bank
 - 1 2 Banks
- 2 Reserved** always reads 0
- 1-0 Cache Size** (bit-0 default set from inverse of HA31)
 - 00 256K
 - 01 512K
 - 10 1M
 - 11 2M

Table 3. COAST Module Detection

Pins HA28-31 have internal pull-ups (external pull-downs may be used to change the default value read on reset) and TA8 has an internal pull-down (an external pull-up may be used to change the default value). The bits affected are:

- Rx51[0] = Cache Size bit-0 = not HA31
- Rx51[1] = Cache Size bit-1 = reset to 0 (no 1M/2M detect)
- Rx51[3] = SRAM Banks = not HA29 (inverted HA29)

- Device 0 Offset 52 - Non-Cacheable Control RW
- 7 **C0000-C7FFF Cacheable & Write-Protect ...** def=0
 - 6 **D0000-DFFFF Cacheable & Write-Protect ...** def=0
 - 5 **E0000-EFFFF Cacheable & Write-Protect ...** def=0
 - 4 **F0000-FFFFF Cacheable & Write-Protect....** def=0
 - 3 **Reserved** always reads 0
 - 2 **L2 Fill on Single Read**
 - 0 Normal L2 cache fill.....default
 - 1 Force the requested data to be filled into the L2 cache (provided that L2 cache is enabled), even if the CPU does a read cycle with CACHE# de-asserted. Setting this bit significantly improves performance.
 - 1 **Reserved** always reads 0
 - 0 **L2 Write Thru/Write-Back**
 - 0 Write-Backdefault
 - 1 Write-Thru

Device 0 Offset 53 - System Performance ControlRW

- 7 **Read Around Write**
 - 0 Disabledefault
 - 1 Enable
- 6 **Cache Read Pipeline Cycle**
 - 0 Disabledefault
 - 1 Enable
- 5 **Cache Write Pipeline Cycle**
 - 0 Disabledefault
 - 1 Enable
- 4 **DRAM Read Pipeline Cycle**
 - 0 Disabledefault
 - 1 Enable
- 3-0 **Reserved** always reads 0

Device 0 Offset 55-54 - Non-Cacheable Region #1..... RW

- 15-3 **Base Address - A<28:16>** default=0
As noted below, the base address must be a multiple of the region size.
- 2-0 **Range (Region Size)**
 - 000 Disable..... default
 - 001 64K
 - 010 128K (Base Address A16 must be 0)
 - 011 256K (Base Address A16-17 must be 0)
 - 100 512K (Base Address A16-18 must be 0)
 - 101 1M (Base Address A16-19 must be 0)
 - 110 2M (Base Address A16-20 must be 0)
 - 111 4M (Base Address A16-21 must be 0)

Device 0 Offset 57-56 - Non-Cacheable Region #2..... RW

- 15-3 **Base Address MSBs - A<28:16>** default=0
As noted below, the base address must be a multiple of the region size.
- 2-0 **Range (Region Size)**
 - 000 Disable..... default
 - 001 64K
 - 010 128K (Base Address A16 must be 0)
 - 011 256K (Base Address A16-17 must be 0)
 - 100 512K (Base Address A16-18 must be 0)
 - 101 1M (Base Address A16-19 must be 0)
 - 110 2M (Base Address A16-20 must be 0)
 - 111 4M (Base Address A16-21 must be 0)

DRAM Control

These registers are normally set at system initialization time and not accessed after that during normal system operation. Some of these registers, however, may need to be programmed using specific sequences during power-up initialization to properly detect the type and size of installed memory (refer to the VIA Technologies 82C597 BIOS porting guide for details).

Table 4. System Memory Map

Space	Start	Size	Address Range	Comment
DOS	0	640K	00000000-0009FFFF	Cacheable
VGA	640K	128K	000A0000-000BFFFF	Used for SMM
BIOS	768K	16K	000C0000-000C3FFF	Shadow Ctrl 1
BIOS	784K	16K	000C4000-000C7FFF	Shadow Ctrl 1
BIOS	800K	16K	000C8000-000CBFFF	Shadow Ctrl 1
BIOS	816K	16K	000CC000-000CFFFF	Shadow Ctrl 1
BIOS	832K	16K	000D0000-000D3FFF	Shadow Ctrl 2
BIOS	848K	16K	000D4000-000D7FFF	Shadow Ctrl 2
BIOS	864K	16K	000D8000-000DBFFF	Shadow Ctrl 2
BIOS	880K	16K	000DC000-000DFFFF	Shadow Ctrl 2
BIOS	896K	64K	000E0000-000EFFFF	Shadow Ctrl 3
BIOS	960K	64K	000F0000-000FFFFFFF	Shadow Ctrl 3
Sys Bus	1MB D Top	—	00100000-DRAM Top	Can have hole
Init	4G-64K	64K	FFFEFFFF-FFFFFFF	000Fxxxx alias

Device 0 Offset 59-58 - DRAM MA Map Type.....RW

- 15-13 Bank 5/4 MA Map Type (EDO/FPG)**
 - 000 8-bit Column Address
 - 001 9-bit Column Address
 - 010 10-bit Column Addressdefault
 - 011 11-bit Column Address
 - 100 12-bit Column Address (64Mb)
 - 101 Reserved
 - 11x Reserved
- Bank 5/4 MA Map Type (SDRAM)**
 - 0xx 16Mbit SDRAM.....default
 - 1xx 64Mbit SDRAM
- 12-8 Reserved** always reads 0
- 7-5 Bank 1/0 MA Map Type (see above)**
- 4 Reserved** always reads 0
- 3-1 Bank 3/2 MA Map Type (see above)**
- 0 Reserved** always reads 0

Device 0 Offset 5A-5F - DRAM Row Ending Address:

All of the registers in this group default to 01h:

- Offset 5A - Bank 0 Ending (HA[30:23]) RW**
- Offset 5B - Bank 1 Ending (HA[30:23])..... RW**
- Offset 5C - Bank 2 Ending (HA[30:23]) RW**
- Offset 5D - Bank 3 Ending (HA[30:23]) RW**
- Offset 5E - Bank 4 Ending (HA[30:23])..... RW**
- Offset 5F - Bank 5 Ending (HA[30:23])..... RW**

Note :BIOS is required to fill the ending address registers for all banks even if no memory is populated. The endings have to be in incremental order.

Device 0 Offset 60 - DRAM Type RW

- 7-6 Reserved** always reads 0
- 5-4 DRAM Type for Bank 5/4**
 - 00 Fast Page Mode DRAM (FPG)..... default
 - 01 EDO DRAM (EDO)
 - 10 SDRAM Double Data Rate (DDR SDRAM-II)
 - 11 SDRAM Single Data Rate (SDR SDRAM)
- 3-2 DRAM Type for Bank 3/2.....default=FPG**
- 1-0 DRAM Type for Bank 1/0.....default=FPG**

Table 5. Memory Address Mapping Table

EDO/FP DRAM

MA:	13	12	11	10	9	8	7	6	5	4	3	2	1	0	
8-bit Col (000)		23	22	21	11	20	19	18	17	16	15	14	13	12	Row Bits Col Bits
9-bit Col (001)		24	23	22	21	20	19	18	17	16	15	14	13	12	Row Bits Col Bits
10-bit Col (010)		25	24	23	21	20	19	18	17	16	15	14	13	12	Row Bits Col Bits
11-bit Col (011)		26	25	23	21	20	19	18	17	16	15	14	13	12	Row Bits Col Bits
12-bit Col (100)		27	25	23	21	20	19	18	17	16	15	14	13	12	Row Bits Col Bits

SDRAM

MA:	13	12	11	10	9	8	7	6	5	4	3	2	1	0	
16Mb (0xx)			11	22	21	20	19	18	17	16	15	14	13	12	Row Bits Col Bits
64Mb (1xx) (Rev A)	25	13	12	22	21	20	19	18	17	16	15	14	24	23	x4: 10 col x8: 9 col
64Mb (1xx) (Rev B Production Silicon)	24	13	12	22	21	20	19	18	17	16	15	14	11	23	x4: 10 col x8: 9 col x16: 8 col x32: 8 col

"PC" = "Precharge Control" (refer to SDRAM specifications)

- 16Mb 11x10, 11x9, and 11x8 configurations supported
- 64Mb x4: 12x10 4bank, 13x10 2bank supported
- x8: 12x9 4bank, 13x9 2bank supported
- x16: 12x8 4bank, 13x8 2bank supported
- x32: 11x8 4bank, 2bank (2Mx32) not supported

Device 0 Offset 61 - Shadow RAM Control 1RW

- 7-6 CC000h-CFFFFh**
 - 00 Read/write disabledefault
 - 01 Write enable
 - 10 Read enable
 - 11 Read/write enable
- 5-4 C8000h-CBFFFh**
 - 00 Read/write disabledefault
 - 01 Write enable
 - 10 Read enable
 - 11 Read/write enable
- 3-2 C4000h-C7FFFh**
 - 00 Read/write disabledefault
 - 01 Write enable
 - 10 Read enable
 - 11 Read/write enable
- 1-0 C0000h-C3FFFh**
 - 00 Read/write disabledefault
 - 01 Write enable
 - 10 Read enable
 - 11 Read/write enable

Device 0 Offset 62 - Shadow RAM Control 2RW

- 7-6 DC000h-DFFFFh**
 - 00 Read/write disabledefault
 - 01 Write enable
 - 10 Read enable
 - 11 Read/write enable
- 5-4 D8000h-DBFFFh**
 - 00 Read/write disabledefault
 - 01 Write enable
 - 10 Read enable
 - 11 Read/write enable
- 3-2 D4000h-D7FFFh**
 - 00 Read/write disabledefault
 - 01 Write enable
 - 10 Read enable
 - 11 Read/write enable
- 1-0 D0000h-D3FFFh**
 - 00 Read/write disabledefault
 - 01 Write enable
 - 10 Read enable
 - 11 Read/write enable

Device 0 Offset 63 - Shadow RAM Control 3..... RW

- 7-6 E0000h-EFFFFh**
 - 00 Read/write disable default
 - 01 Write enable
 - 10 Read enable
 - 11 Read/write enable
- 5-4 F0000h-FFFFFh**
 - 00 Read/write disable default
 - 01 Write enable
 - 10 Read enable
 - 11 Read/write enable
- 3-2 Memory Hole**
 - 00 None default
 - 01 512K-640K
 - 10 15M-16M (1M)
 - 11 14M-16M (2M)
- 1-0 SMI Mapping Control**
 - 00 Disable SMI Address Redirection default
 - 01 Allow access to DRAM Axxxx-Bxxxx
 - 10 SMI 3xxxx-4xxxx redirect to Axxxx-Bxxxx
(30000-4FFFFh is automatically set to noncachable)
 - 11 Allow SMI Axxxx-Bxxxx DRAM access

Note: The A0000-BFFFF address range is reserved for use by VGA controllers for system access to the VGA frame buffer. Since frame buffer accesses are normally directed to the system VGA controller (with its separate memory subsystem), system DRAM locations in the A0000-BFFFF range would normally be unused. Setting the above bits appropriately allows this block of system memory to be used by directing Axxxx-Bxxxx accesses (in System Management Mode) to corresponding memory addresses in system DRAM instead of directing those accesses to the PCI bus for VGA frame buffer access.

Device 0 Offset 64 - DRAM Timing for Banks 0,1RW

Device 0 Offset 65 - DRAM Timing for Banks 2,3RW

Device 0 Offset 66 - DRAM Timing for Banks 4,5RW

FPG / EDO Settings for Registers 64-66

- 7 RAS Precharge Time**
 - 0 3T
 - 1 4Tdefault
- 6 RAS Pulse Width**
 - 0 4T
 - 1 5Tdefault
- 5-4 CAS Read Pulse Width**
 - 00 1T
 - 01 2T
 - 10 3Tdefault
 - 11 4T

Note: EDO will not automatically reduce the CAS pulse width. For EDO type DRAMs, use 00 if CAS width = 1 is to be used.
- 3 CAS Write Pulse Width**
 - 0 1T
 - 1 2Tdefault
- 2 MA-to-CAS Delay**
 - 0 1T
 - 1 2Tdefault
- 1 RAS to MA Delay**
 - 0 1Tdefault
 - 1 2T
- 0 Reserved** always reads 0

SDRAM Settings for Registers 64-66

- 7 Precharge Command to Active Command Period**
 - 0 $T_{RP} = 2T$
 - 1 $T_{RP} = 3T$ default
- 6 Active Command to Precharge Command Period**
 - 0 $T_{RAS} = 5T$
 - 1 $T_{RAS} = 6T$ default
- 5-4 CAS Latency**

	<u>SDRAM</u>	<u>SDRAM-II</u>	
00	1T	n/a	
01	2T	n/a	
10	3T	2T, 2.5T default
11	n/a	3T	
- 3 DDR Write Enable (SDRAM-II Only)**
 - 0 Disable..... default
 - 1 Enable
- 2 ACTIVE Command to CMD Command Period**
 - 0 2T
 - 1 3T default
- 1-0 Bank Interleave**
 - 00 No Interleave default
 - 01 2-way
 - 10 4-way
 - 11 Reserved

Device 0 Offset 68 - DRAM Control.....RW

- 7 SDRAM Open Page Control**
 - 0 Always precharge SDRAM banks when accessing EDO/FPG DRAMs.....default
 - 1 SDRAM banks remain active when accessing EDO/FPG banks †
- 6 Bank Page Control**
 - 0 Allow only pages of the same bank active... def
 - 1 Allow pages of different banks to be active †
- 5 EDO Pipeline Burst Rate**
 - 0 X-2-2-2-2-2-2-2.....default
 - 1 X-2-2-2-3-2-2-2
- 4 DRAM Data Latch Delay (EDO/FPG only)**
 - 0 Latch DRAM data at CCLK rising edge def
 - 1 Delay latch of DRAM data by ½ clock
- 3 EDO Test Mode**
 - 0 Disabledefault
 - 1 Enable
- 2 Burst Refresh**
 - 0 Disabledefault
 - 1 Enable (burst 4 times)
- 1 MCACHE Enable** default set from TA8 pin
 - 0 Disable
 - 1 Enable
- 0 Reserved** always reads 0

Note: MD0 is internally pulled up for EDO detection.

Device 0 Offset 6A - Refresh CounterRW

- 7-0 Refresh Counter** (in units of 16 CPUCLKs)
 - 00 DRAM Refresh Disableddefault
 - 01 32 CPUCLKs
 - 02 48 CPUCLKs
 - 03 64 CPUCLKs
 - 04 80 CPUCLKs
 - 05 96 CPUCLKs
 -

The programmed value is the desired number of 16-CPUCLK units minus one.

Note: Only CBR refresh is supported

Device 0 Offset 6B - DRAM Arbitration Control.....RW

- 7-6 Arbitration Parking Policy**
 - 00 Park at last bus owner.....default
 - 01 Park at CPU side
 - 10 Park at AGP side
 - 11 Reserved
- 5-1 Reserved** always reads 0
- 0 Multi-Page Open**
 - 0 Disable (page registers marked invalid and no page register update which causes non page-mode operation)
 - 1 Enable (see note † at right)default

Device 0 Offset 6C - SDRAM Control RW

- 7-5 Reserved**always reads 0
- 4 DDR Write-to-Read Turnaround**
 - 0 1T Turnaround (i.e., 3T from Write command to Read command)..... default
 - 1 2T Turnaround
- 3 Single RW Burst Stop Command**
 - 0 Disable..... default
 - 1 Enable BST command to SDRAM to allow fast single-cycle pipeline
- 2-0 SDRAM Operation Mode Select**
 - 000 Normal SDRAM Mode..... default
 - 001 NOP Command Enable
 - 010 All-Banks-Precharge Command Enable (CPU-to-DRAM cycles are converted to All-Banks-Precharge commands).
 - 011 MSR Enable
CPU-to-DRAM cycles are converted to commands and the commands are driven on MA[13:0]. The BIOS selects an appropriate host address for each row of memory such that the right commands are generated on MA[13:0].
 - 100 CBR Cycle Enable (if this code is selected, CAS-before-RAS refresh is used; if it is not selected, RAS-Only refresh is used)
 - 101 Reserved
 - 11x Reserved

Device 0 Offset 6D - DRAM Drive Strength..... RW

- 7-4 Reserved**always reads 0
- 3 SDRAM Command Drive (SRAS#, SCAS#, SWE#)**
 - 0 16mA default
 - 1 24mA
- 2 MA[2:13] / WE# Drive**
 - 0 16mA default
 - 1 24mA
- 1 CAS# Drive**
 - 0 8 mA default
 - 1 12 mA
- 0 RAS# Drive**
 - 0 16mA default
 - 1 24mA

† Note: For SDRAM, Rx68[6], Rx68[7], and Rx6B[0] should all be programmed to 1 and the bank interleave bits in Rx64-66 (bits 1-0) should be set to either 2-way or 4-way interleave. All other combinations are for test purposes only.

Device 0 Offset 6E - ECC ControlRW

- 7 ECC / EMode Select**
 - 0 ECC Checking and Reportingdefault
 - 1 ECC Checking, Reporting, and Correcting
- 6 Reserved** always reads 0
- 5 Enable SERR# on ECC / EC Multi-Bit Error**
 - 0 Don't assert SERR# for multi-bit errors..... def
 - 1 Assert SERR# for multi-bit errors
- 4 Enable SERR# on ECC / EC Single-Bit Error**
 - 0 Don't assert SERR# for single-bit errors..... def
 - 1 Assert SERR# for single-bit errors
- 3 Reserved** always reads 0
- 2 ECC / EC Enable - Bank 5/4 (DIMM 2)**
 - 0 Disable (no ECC or EC for banks 5/4)...default
 - 1 Enable (ECC or EC per bit-7)
- 1 ECC / EC Enable - Bank 3/2 (DIMM 1)**
 - 0 Disable (no ECC or EC for banks 3/2)...default
 - 1 Enable (ECC or EC per bit-7)
- 0 ECC / EC Enable - Bank 1/0 (DIMM 0)**
 - 0 Disable (no ECC or EC for banks 1/0)...default
 - 1 Enable (ECC or EC per bit-7)

Device 0 Offset 6F - ECC Status..... RWC

- 7 Multi-bit (ECC) Error Detected...** write of '1' resets
- 6-4 Multi-bit (ECC) Error DRAM Bank** default=0
Encoded value of the bank with the multi-bit error.
- 3 Single-bit (Parity) Error Detected** write of '1' resets
- 2-0 Single-bit (Parity) Error DRAM Bank** default=0
Encoded value of the bank with the single-bit error.

Error checking / correction may be enabled bank-pair by bank-pair by using bits 0-2 above. Bank pairs must be populated with 72-bit memory to enable for EC or ECC since the additional data bits must be present in either case. For this reason, if 64-bit memory is populated in a particular bank pair, the corresponding bit 0-2 should be set to 0 to disable both EC and ECC for that bank pair. For those bank pairs that have 72-bit memory available (and have the corresponding bit 0-2 set), either EC or ECC may be selected via bit-7 above (i.e., all enabled bank pairs will use EC or all will use ECC).

If error checking / reporting only (EC) is selected, all read and write cycles will use normal timing. Partial writes (with EC or ECC enabled) will use read-modify-write cycles to maintain correct error correction codes in the additional 8 data bits. If EC and ECC are disabled for a particular bank pair, partial writes to that bank pair will use the byte enables to write only the selected bytes (using normal write cycles and cycle timing). If error correction (ECC) is selected, the first read of a transaction will always have one additional cycle of latency.

Bit-7 Bits 2-0 RMW Error Checking Error Correction

0/1	0	No	No	No
	1	Yes	Yes	No
	1	Yes	Yes	Yes

PCI Bus #1 Control

These registers are normally programmed once at system initialization time.

Device 0 Offset 70 - PCI Buffer ControlRW

- 7 CPU to PCI Post-Write**
 - 0 Disabledefault
 - 1 Enable
- 6 PCI Master to DRAM Post-Write**
 - 0 Disabledefault
 - 1 Enable
- 5 PCI Master to DRAM Prefetch**
 - 0 Disabledefault
 - 1 Enable
- 4 Reserved** RW
- 3-1 Reserved** always reads 0
- 0 Delay Transaction Optimization**
 - 0 Disabledefault
 - 1 Enable

Device 0 Offset 71 - CPU to PCI Flow Control 1 RW

- 7 Dynamic Burst**
 - 0 Disable default
 - 1 Enable (see note under bit-3 below)
- 6 Byte Merge**
 - 0 Disable default
 - 1 Enable
- 5 Reserved**RW
- 4 PCI I/O Cycle Post Write**
 - 0 Disable default
 - 1 Enable
- 3 PCI Burst**
 - 0 Disable default
 - 1 Enable (bit7=1 will override this option)
- bit-7 bit-3 Operation**
 - 0 0 Every write goes into the write buffer and no PCI burst operations occur.
 - 0 1 If the write transaction is a burst transaction, the information goes into the write buffer and burst transfers are later performed on the PCI bus. If the transaction is not a burst, PCI write occurs immediately (after a write buffer flush).
 - 1 x Every write transaction goes to the write buffer; burstable transactions will then burst on the PCI bus and non-burstable won't. This is the normal setting.
- 2 PCI Fast Back-to-Back Write**
 - 0 Disable default
 - 1 Enable
- 1 Quick Frame Generation**
 - 0 Disable default
 - 1 Enable
- 0 1 Wait State PCI Cycles**
 - 0 Disable default
 - 1 Enable

Device 0 Offset 72 - CPU to PCI Flow Control 2.....RW

- 7 Retry Status over 16 / 64 Times**
 - 0 No retry occurreddefault
 - 1 Retry occurred.....write 1 to clear
- 6 Retry Timeout Action**
 - 0 Retry Forever (record status only).....default
 - 1 Flush buffer for write or return all 1s for read
- 5-4 Retry Count and Retry Backoff**
 - 00 Retry 2 timesdefault
 - 01 Retry 16 times
 - 10 Retry 4 times
 - 11 Retry 64 times
- 3 Clear Failed Data and Continue Retry**
 - 0 Flush the entire post-write bufferdefault
 - 1 When data is posting and master (or target) abort fails, pop the failed data if any, and keep posting
- 2 CPU Backoff on PCI Read Retry Failure**
 - 0 Disabledefault
 - 1 Backoff CPU when reading data from PCI and retry fails
- 1 Reduce 1T for FRAME# Generation**
 - 0 Disabledefault
 - 1 Enable
- 0 Reduce 1T for CPU Read PCI Slave**
 - 0 Disabledefault
 - 1 Enable (bypass TRDY# to LRDY#)

Device 0 Offset 73 - PCI Master Control 1..... RW

- 7 Reserved**always reads 0
- 6 PCI Master 1-Wait-State Write**
 - 0 Zero wait state TRDY# response default
 - 1 One wait state TRDY# response
- 5 PCI Master 1-Wait-State Read**
 - 0 Zero wait state TRDY# response default
 - 1 One wait state TRDY# response
- 4 Reserved**always reads 0
- 3 Assert STOP# after PCI Master Write Timeout**
 - 0 Disable..... default
 - 1 Enable
- 2 Assert STOP# after PCI Master Read Timeout**
 - 0 Disable..... default
 - 1 Enable
- 1 LOCK# Function**
 - 0 Disable..... default
 - 1 Enable
- 0 PCI Master Broken Timer Enable**
 - 0 Disable..... default
 - 1 Enable. Force into arbitration when there is no FRAME# 16 PCICLK's after the grant.

Device 0 Offset 74 - PCI Master Control 2..... RW

- 7 PCI Master Read Prefetch by Enhance Command**
 - 0 Always Prefetch..... default
 - 1 Prefetch only if Enhance command
- 6 PCI Master Write Merge**
 - 0 Disable..... default
 - 1 Enable
- 5-0 Reserved**always reads 0

Device 0 Offset 75 - PCI Arbitration 1RW

- 7 Arbitration Mechanism**
 - 0 PCI has prioritydefault
 - 1 Fair arbitration between PCI and CPU
- 6 Arbitration Mode**
 - 0 REQ-based (arbitrate at end of REQ#)...default
 - 1 Frame-based (arbitrate at end of each FRAME#)
- 5-4 Latency Timer** read only, reads Rx0D bits 2:1
- 3-0 PCI Master Bus Time-Out**
(force into arbitration after a period of time)
 - 0000 Disabledefault
 - 0001 1x32 PCICLKs
 - 0010 2x32 PCICLKs
 - 0011 3x32 PCICLKs
 - 0100 4x32 PCICLKs
 -
 - 1111 15x32 PCICLKs

Device 0 Offset 76 - PCI Arbitration 2RW

- 7 Master Priority Rotation Enable**
 - 0 Disable (arbitration per Rx75 bit-7)default
 - 1 Enable (arbitration per bits 5-4 of this register)
(gives the CPU higher priority than either of the mechanisms defined by Rx75 bit-7). Note: Always set this bit to 1.
- 6 CPU Latency Timer Bit-0**..... RO
 - 0 CPU has at least 1 PCLK time slot when CPU has PCI bus
 - 1 CPU has no time slot
- 5-4 Master Priority Rotation Control**
 - 00 Disabled (arbitration per Rx75 bit-7)default
 - 01 Grant to CPU after every PCI master grant
 - 10 Grant to CPU after every 2 PCI master grants
 - 11 Grant to CPU after every 3 PCI master grants

With setting 01, the CPU will always be granted access after the current bus master completes, no matter how many PCI masters are requesting. With setting 10, if other PCI masters are requesting during the current PCI master grant, the highest priority master will get the bus after the current master completes, but the CPU will be guaranteed to get the bus after that master completes. With setting 11, if other PCI masters are requesting, the highest priority will get the bus next, then the next highest priority will get the bus, then the CPU will get the bus. In other words, with the above settings, even if multiple PCI masters are continuously requesting the bus, the CPU is guaranteed to get access after every master grant (01), after every other master grant (10) or after every third master grant (11).
- 3-0 Reserved** always reads 0

Device 0 Offset 77 - Chip Test Mode..... RW

- 7-6 Reserved (no function)**always reads 0
- 5-0 Reserved (do not use)** default=0

Device 0 Offset 7E – DLL Test Mode..... RW

- 7-6 Reserved (status)**RO
- 5-3 Reserved (do not use)**default=0
- 2-0 Reserved (no function)** default=0

Device 0 Offset 7F – DLL4 Test Mode..... RW

- 7-0 Reserved (do not use)** default=0

GART / Graphics Aperture Control

The function of the Graphics Address Relocation Table (GART) is to translate virtual 32-bit addresses issued by an AGP device into 4K-page based physical addresses for system memory access. In this translation, the upper 20 bits (A31-A12) are remapped, while the lower 12 address bits (A11-A0) are used unchanged.

A one-level fully associative lookup scheme is used to implement the address translation. In this scheme, the upper 20 bits of the virtual address are used to point to an entry in a page table located in system memory. Each page table entry contains the upper 20 bits of a physical address (a "physical page" address). For simplicity, each page table entry is 4 bytes. The total size of the page table depends on the GART range (called the "aperture size") which is programmable in the VT82C597.

This scheme is shown in the figure below.

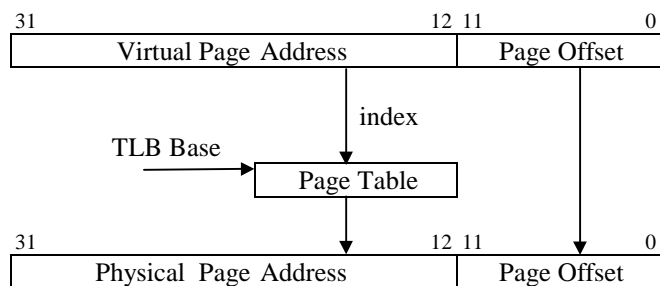

Figure 8. Graphics Aperture Address Translation

Since address translation using the above scheme requires an access to system memory, an on-chip cache (called a "Translation Lookaside Buffer" or TLB) is utilized to enhance performance. The TLB in the 82C597 contains 16 entries. Address "misses" in the TLB require an access of system memory to retrieve translation data. Entries in the TLB are replaced using an LRU (Least Recently Used) algorithm.

Addresses are translated only for accesses within the "Graphics Aperture" (GA). The Graphics Aperture can be any power of two in size from 1MB to 256MB (i.e., 1MB, 2MB, 4MB, 8MB, etc). The base of the Graphics Aperture can be anywhere in the system virtual address space on an address boundary determined by the aperture size (e.g., if the aperture size is 4MB, the base must be on a 4MB address boundary). The Graphics Aperture Base is defined in register offset 10 of device 0. The Graphics Aperture Size and TLB Table Base are defined in the following register group (offsets 84 and 88 respectively) along with various control bits.

Device 0 Offset 83-80 - GART/TLB Control.....RW

- 31-16 **Reserved** always reads 0
- 15-8 **Reserved (test mode status)**..... RO

- 7 **Flush Page TLB**
 - 0 Disabledefault
 - 1 Enable

- 6-4 **Reserved** always reads 0

- 3 **PCI#1 Master Address Translation for GA Access**
 - 0 Addresses generated by PCI #1 Master accesses of the Graphics Aperture will not be translateddefault
 - 1 PCI #1 Master GA addresses will be translated
- 2 **PCI#2 Master Address Translation for GA Access**
 - 0 Addresses generated by PCI #2 Master accesses of the Graphics Aperture will not be translateddefault
 - 1 PCI #2 Master GA addresses will be translated
- 1 **CPU Address Translation for GA Access**
 - 0 Addresses generated by CPU accesses of the Graphics Aperture will not be translated..... def
 - 1 CPU GA addresses will be translated
- 0 **AGP Address Translation for GA Access**
 - 0 Addresses generated by AGP accesses of the Graphics Aperture will not be translated..... def
 - 1 AGP GA addresses will be translated

Note: For any master access to the Graphics Aperture range, snoop will not be performed.

Device 0 Offset 84 - Graphics Aperture Size..... RW

- 7-0 **Graphics Aperture Size**
 - 11111111 1M
 - 11111110 2M
 - 11111100 4M
 - 11111000 8M
 - 11110000 16M
 - 11100000 32M
 - 11000000 64M
 - 10000000 128M
 - 00000000 256M
- 3-0 **Reserved** always reads 0

Offset 8B-88 - GA Translation Table Base..... RW

- 31-12 **Graphics Aperture Translation Table Base.**
Pointer to the base of the translation table in system memory used to map addresses in the aperture range (the pointer to the base of the "Directory" table).
 - 11-2 **Reserved** always reads 0
 - 1 **Graphics Aperture Enable**
 - 0 Disable..... default
 - 1 Enable
- Note: To disable the Graphics Aperture, set this bit to 0 and set all bits of the Graphics Aperture Size to 0. To enable the Graphics Aperture, set this bit to 1 and program the Graphics Aperture Size to the desired aperture size.
- 0 **Translation Table Noncachable**
 - 0 Cachable default
 - 1 Non-cachable

Note: Setting this bit will make the address range programmed in bits 31-12 of this register non-cachable to L1/L2 with the following bits masked per the Graphics Aperture Size (offset 84 described above):

- Address bit 17 masked if Size bit-7 = 0
- Address bit 16 masked if Size bit-6 = 0
- Address bit 15 masked if Size bit-5 = 0
- Address bit 14 masked if Size bit-4 = 0
- Address bit 13 masked if Size bit-3 = 0
- Address bit 12 masked if Size bit-2 = 0
- Address bit 11 masked if Size bit-1 = 0
- Address bit 10 masked if Size bit-0 = 0

Note: If TLB miss, the TLB table is fetched by the address:

Gr Ap Trans Table Base [31:12] + A[27:22], A[21:12], 2'b00

AGP Control
Device 0 Offset A3-A0 - AGP Capability IdentifierRO

- 31-24 Reserved** always reads 00
- 23-20 Major Specification Revision** always reads 0001
Major revision # of AGP spec device conforms to
- 19-16 Minor Specification Revision** always reads 0000
Minor revision # of AGP spec device conforms to
- 15-8 Pointer to Next Item**..... always reads 00 (last item)
- 7-0 AGP ID** .. (always reads 02 to indicate it is AGP)

Device 0 Offset A7-A4 - AGP Status.....RO

- 31-24 Maximum AGP Requests** always reads 07
Max # of AGP requests the device can manage (8)
- 23-10 Reserved**always reads 0s
- 9 Supports SideBand Addressing** always reads 1
- 8-2 Reserved**always reads 0s
- 1 2X Rate Supported**..... always reads 1
- 0 1X Rate Supported**..... always reads 1

Device 0 Offset AB-A8 - AGP Command.....RW

- 31-24 Request Depth** (reserved for target)...always reads 0s
- 23-10 Reserved**always reads 0s
- 9 SideBand Addressing Enable**
 - 0 Disabledefault
 - 1 Enable
- 8 AGP Enable**
 - 0 Disabledefault
 - 1 Enable
- 7-2 Reserved**always reads 0s
- 1 2X Mode Enable**
 - 0 Disabledefault
 - 1 Enable
- 0 1X Mode Enable**
 - 0 Disabledefault
 - 1 Enable

Device 0 Offset AC - AGP Control..... RW

- 7-3 Reserved** always reads 0s
- 2 LPR In-Order Access (Force Fence)**
 - 0 Fence/Flush functions not guaranteed. AGP read requests (low/normal priority and high priority) may be executed before previously issued write requests. default
 - 1 Force all requests to be executed in order (automatically enables Fence/Flush functions). Low (i.e., normal) priority AGP read requests will never be executed before previously issued writes. High priority AGP read requests may still be executed prior to previously issued write requests as required.
- 1 Reserved** (always write 0)..... R/W, default=0
- 0 Fast Response for Low Priority Read**
 - 0 Wait for data of entire transaction is received before grant is generated..... default
 - 1 Generate grant immediately after first block of data is received

Device 1 Header Registers - PCI-to-PCI Bridge

All registers are located in PCI configuration space. They should be programmed using PCI configuration mechanism 1 through CF8 / CFC with bus number of 0 and function number equal to 0 and device number equal to one.

Device 1 Offset 1-0 - Vendor ID.....RO

15-0 ID Code (reads 1106h to identify VIA Technologies)

Device 1 Offset 3-2 - Device ID.....RO

15-0 ID Code (reads 8597h to identify the VT82C597 PCI-to-PCI Bridge device)

Device 1 Offset 5-4 - Command.....RW

15-10 Reserved always reads 0

9 Fast Back-to-Back Cycle Enable RO

- 0 Fast back-to-back transactions only allowed to the same agentdefault
- 1 Fast back-to-back transactions allowed to different agents

8 SERR# Enable..... RO

- 0 SERR# driver disableddefault
 - 1 SERR# driver enabled
- (SERR# is used to report parity errors if bit-6 is set).

7 Address / Data Stepping RO

- 0 Device never does steppingdefault
- 1 Device always does stepping

6 Parity Error Response..... RW

- 0 Ignore parity errors & continuedefault
- 1 Take normal action on detected parity errors

5 VGA Palette Snoop RO

- 0 Treat palette accesses normallydefault
- 1 Don't respond to palette writes on PCI bus (10-bit decode of I/O addresses 3C6-3C9 hex)

4 Memory Write and Invalidate Command..... RO

- 0 Bus masters must use Mem Writedefault
- 1 Bus masters may generate Mem Write & Inval

3 Special Cycle Monitoring RO

- 0 Does not monitor special cyclesdefault
- 1 Monitors special cycles

2 Bus Master RW

- 0 Never behaves as a bus master
- 1 Enable to operate as a bus master on the primary interface on behalf of a master on the secondary interfacedefault

1 Memory Space..... RW

- 0 Does not respond to memory space
- 1 Enable memory space accessdefault

0 I/O Space RW

- 0 Does not respond to I/O space
- 1 Enable I/O space accessdefault

Device 1 Offset 7-6 - Status (Primary Bus)..... RWC

15 Detected Parity Erroralways reads 0

14 Signaled System Error (SERR#)always reads 0

13 Signaled Master Abort

- 0 No abort received default
- 1 Transaction aborted by the master with Master-Abort (except Special Cycles) write 1 to clear

12 Received Target Abort

- 0 No abort received default
- 1 Transaction aborted by the target with Target-Abort write 1 to clear

11 Signaled Target Abort.....always reads 0

10-9 DEVSEL# Timing

- 00 Fast
- 01 Medium.....always reads 01
- 10 Slow
- 11 Reserved

8 Data Parity Error Detectedalways reads 0

7 Fast Back-to-Back Capablealways reads 0

6 User Definable Features.....always reads 0

5 66MHz Capable.....always reads 1

4 Supports New Capability list.....always reads 0

3-0 Reservedalways reads 0

Device 1 Offset 8 - Revision ID RO

7-0 VT82C597 Chip Revision Code (00=First Silicon)

Device 1 Offset 9 - Programming Interface RO

This register is defined in different ways for each Base/Sub-Class Code value and is undefined for this type of device.

7-0 Interface Identifieralways reads 00

Device 1 Offset A - Sub Class Code..... RO

7-0 Sub Class Code .reads 04 to indicate PCI-PCI Bridge

Device 1 Offset B - Base Class Code..... RO

7-0 Base Class Code ..reads 06 to indicate Bridge Device

Device 1 Offset D - Latency Timer RO

7-0 Reservedalways reads 0

Device 1 Offset E - Header Type RO

7-0 Header Type Code.....reads 01: PCI-PCI Bridge

Device 1 Offset F - Built In Self Test (BIST) RO

7 BIST Supported..... reads 0: no supported functions

6 Start Test write 1 to start but writes ignored

5-4 Reservedalways reads 0

3-0 Response Code0 = test completed successfully

Device 1 Offset 18 - Primary Bus NumberRW

7-0 Primary Bus Number default = 0

This register is read write, but internally the chip always uses bus 0 as the primary.

Device 1 Offset 19 - Secondary Bus NumberRW

7-0 Secondary Bus Number default = 0

Note: PCI#2 must use these bits to convert Type 1 to Type 0.

Device 1 Offset 1A - Subordinate Bus NumberRW

7-0 Primary Bus Number default = 0

Note: PCI#2 must use these bits to decide if Type 1 to Type 1 command passing is allowed.

Device 1 Offset 1C - I/O BaseRW

7-4 I/O Base AD[15:12] default = 1111b

3-0 I/O Addressing Capability default = 0

Device 1 Offset 1D - I/O LimitRW

7-4 I/O Limit AD[15:12] default = 0

3-0 I/O Addressing Capability default = 0

Device 1 Offset 1F-1E - Secondary Status RO

15-0 Reserved always reads 0000

Device 1 Offset 21-20 - Memory Base RW

15-4 Memory Base AD[31:20] default = 0FFFh

3-0 Reserved always reads 0

Device 1 Offset 23-22 - Memory Limit (Inclusive) RW

15-4 Memory Limit AD[31:20] default = 0

3-0 Reserved always reads 0

Device 1 Offset 25-24 - Prefetchable Memory Base RW

15-4 Prefetchable Memory Base AD[31:20] def = 0FFFh

3-0 Reserved always reads 0

Device 1 Offset 27-26 - Prefetchable Memory Limit RW

15-4 Prefetchable Memory Limit AD[31:20] default = 0

3-0 Reserved always reads 0

Device 1 Offset 3F-3E – PCI-to-PCI Bridge Control RW

15-4 Reserved always reads 0

3 VGA-Present on AGP

0 Forward VGA accesses to PCI Bus #1 .. default

1 Forward VGA accesses to PCI Bus #2 / AGP

Note: VGA addresses are memory A0000-BFFFFh and I/O addresses 3B0-3BBh, 3C0-3CFh and 3D0-3DFh (10-bit decode). "Mono" text mode uses B0000-B7FFFh and "Color" Text Mode uses B8000-BFFFFh. Graphics modes use Axxxxh. Mono VGA uses I/O addresses 3Bx-3Cxh and Color VGA uses 3Cx-3Dxh. If an MDA is present, a VGA will not use the 3Bxh I/O addresses and B0000-B7FFFh memory space; if not, the VGA will use those addresses to emulate MDA modes.

2 Block / Forward ISA I/O Addresses

0 Forward all I/O accesses to the AGP bus if they are in the range defined by the I/O Base and I/O Limit registers (device 1 offset 1C-1D) default

1 Do not forward I/O accesses to the AGP bus that are in the 100-3FFh address range even if they are in the range defined by the I/O Base and I/O Limit registers.

1-0 Reserved always reads 0

Device 1 Configuration Registers - PCI-to-PCI Bridge

PCI Bus #2 Control

Device 1 Offset 40 - CPU-to-PCI #2 Flow Control 1..RW

- 7 CPU-PCI #2 Post Write**
 - 0 Disabledefault
 - 1 Enable
- 6 CPU-PCI #2 Dynamic Burst**
 - 0 Disabledefault
 - 1 Enable
- 5 CPU-PCI #2 One Wait State Burst Write**
 - 0 Disabledefault
 - 1 Enable
- 4-3 Reserved** default = 0
- 2 MDA Present on PCI #2**
 - 0 Forward MDA accesses to AGP.....default
 - 1 Forward MDA accesses to PCI #1

Note: Forward despite IO / Memory Base / Limit
 Note: MDA (Monochrome Display Adapter) addresses are memory addresses B0000h-B7FFFh and I/O addresses 3B4-3B5h, 3B8-3BAh, and 3BFh (10-bit decode). 3BC-3BE are reserved for printers.
 Note: If Rx3E bit-3 is 0, this bit is a don't care (MDA accesses are forwarded to the PCI bus).

- 1-0 Reserved** default = 0

Table 6. VGA/MDA Memory/IO Redirection

<u>3E[3]</u> <u>VGA</u> <u>Pres.</u>	<u>40[2]</u> <u>MDA</u> <u>Pres.</u>	<u>VGA</u> <u>is</u> <u>on</u>	<u>MDA</u> <u>is</u> <u>on</u>	<u>Axxxx,</u> <u>B8xxx</u> <u>Access</u>	<u>B0000</u> <u>-B7FFF</u> <u>Access</u>	<u>3Cx,</u> <u>3Dx</u> <u>I/O</u>	<u>3Bx</u> <u>I/O</u>
0	-	PCI	PCI	PCI	PCI	PCI	PCI
1	0	AGP	AGP	AGP	AGP	AGP	AGP
1	1	AGP	PCI	AGP	PCI	AGP	PCI

Device 1 Offset 41 - CPU-to-PCI #2 Flow Control 2 RW

- 7 Retry Status**
 - 0 No retry occurred..... default
 - 1 Retry Occurred (write 1 to clear)
- 7 Retry Timeout Action**
 - 0 No action taken except to record status def
 - 1 Flush buffer for write or return all 1s for read
- 5-4 Retry Count**
 - 00 Retry 2, backoff CPU default
 - 01 Retry 4, backoff CPU
 - 10 Retry 16, backoff CPU
 - 11 Retry 64, backoff CPU
- 3 Post Write Data on Abort**
 - 0 Flush entire post-write buffer on target-abort or master abort..... default
 - 1 Pop one data output on target-abort or master-abort
- 2 CPU Backoff on PCI #2 Read Retry Timeout**
 - 0 Disable..... default
 - 1 Enable
- 1-0 Reserved** always reads 0

Device 1 Offset 42 - PCI #2 Master Control..... RW

- 7 Read Prefetch for Enhance Command**
 - 0 Always Perform Prefetch..... default
 - 1 Prefetch only if Enhance Command
- 6 PCI #2 Master One Wait State Write**
 - 0 Disable..... default
 - 1 Enable
- 5 PCI #2 Master One Wait State Read**
 - 0 Disable..... default
 - 1 Enable
- 4 Reserved** always reads 0
- 3 PCI #2 Master Write Timeout Asserts STOP#**
 - 0 Disable..... default
 - 1 Enable
- 2 PCI #2 Master Read Timeout Asserts STOP#**
 - 0 Disable..... default
 - 1 Enable
- 1-0 Reserved** always reads 0

ELECTRICAL SPECIFICATIONS

Absolute Maximum Ratings

Parameter	Min	Max	Unit
Ambient operating temperature	0	70	°C
Storage temperature	-55	125	°C
Input voltage	-0.5	5.5	Volts
Output voltage ($V_{DD} = 3.1 - 3.6V$)	-0.5	$V_{DD} + 0.5$	Volts

Note: Stress above the conditions listed may cause permanent damage to the device. Functional operation of this device should be restricted to the conditions described under operating conditions.

DC Characteristics

TA=0-70°C, $V_{DD}=5V \pm 5\%$, GND=0V

Symbol	Parameter	Min	Max	Unit	Condition
V_{IL}	Input low voltage	-0.50	0.8	V	
V_{IH}	Input high voltage	2.0	$V_{DD}+0.5$	V	
V_{OL}	Output low voltage	-	0.45	V	$I_{OL}=4.0mA$
V_{OH}	Output high voltage	2.4	-	V	$I_{OH}=-1.0mA$
I_{IL}	Input leakage current	-	+/-10	uA	$0 < V_{IN} < V_{DD}$
I_{OZ}	Tristate leakage current	-	+/-20	uA	$0.45 < V_{OUT} < V_{DD}$
I_{CC}	Power supply current	-		mA	

AC Timing Specifications

AC timing specifications provided are based on external zero-pf capacitance load. Min/max cases are based on the following table:

Table 7. AC Timing Min / Max Conditions

Parameter	Min	Max	Unit
3.3V Power (VDD3)	3.135	3.465	Volts
5V Power (VDD5)	4.75	5.25	Volts
Temperature	0	70	°C

Table 8. AC Characteristics - CPU Cycle Timing

Parameter	Min	Max	Unit	Notes
ADS# Setup Time to CCLK Rising	4.2		ns	0pf
W/R# Setup Time to CCLK Rising	4.0		ns	
M/IO# Setup Time to CCLK Rising	4.5		ns	
D/C# Setup Time to CCLK Rising	1.5		ns	
BE[7:0]# Setup Time to CCLK Rising	1.2		ns	
HITM# Setup Time to CCLK Rising	4.2		ns	
CACHE# Setup Time to CCLK Rising	1.1		ns	
HA[31:3] Setup Time to CCLK Rising	3.3		ns	
LOCK# Setup Time to CCLK Rising	3.8		ns	
ADS# Hold Time to CCLK Rising	0.8		ns	
W/R# Hold Time to CCLK Rising	0.7		ns	
M/IO# Hold Time to CCLK Rising	0.7		ns	
D/C# Hold Time to CCLK Rising	0.8		ns	
BE[7:0]# Hold Time to CCLK Rising	0.9		ns	
HITM# Hold Time to CCLK Rising	0.8		ns	
CACHE# Hold time to CCLK Rising	0.8		ns	
HA[31:3] Hold Time to CCLK Rising	0.9		ns	
BRDY# Valid Delay From CCLK Rising	1.9	4.9	ns	
NA# Valid Delay From CCLK Rising	1.6	4.2	ns	
AHOLD Valid Delay From CCLK Rising	1.8	4.6	ns	
BOFF# Valid Delay From CCLK Rising	1.8	4.8	ns	
EADS# Valid Delay From CCLK Rising	1.8	4.6	ns	
KEN#/INV# Valid Delay from CCLK Rising	1.8	4.8	ns	
BE[7:0]# Valid Delay from CCLK Rising	1.6	4.1	ns	
HA[31:3] Valid Delay from CCLK Rising	2.4	6.2	ns	

Table 9. AC Characteristics - L2 Cache Timing

Parameter	Min	Max	Unit	Notes
COE# Valid Delay from CCLK Rising	1.7	4.5	ns	0pf
TA[9:0] Valid Delay from CCLK Rising	2.6	6.1	ns	
TWE# Valid Delay from CCLK Rising	1.6	4.3	ns	
GWE# Valid Delay from CCLK Rising	1.5	4.0	ns	
BWE# Valid Delay from CCLK Rising	1.5	3.9	ns	
CADS# Valid Delay from CCLK Rising	1.7	4.4	ns	
CADV# Valid Delay from CCLK Rising	1.7	4.2	ns	
TA[9:0] setup time to CCLK Rising	6.0		ns	
TA[9:0] Hold Time from CCLK Rising	0.5		ns	

Table 10. AC Characteristics – DRAM Interface Timing

Parameter	Min	Max	Unit	Notes
RAS[5:0]# Valid Delay from CCLK Rising (EDO)	2.6	5.8	ns	0pf
CS[5:0]# Valid Delay from CCLK Rising (SDRAM)	2.5	6.3	ns	
CAS[7:0]# Valid Delay from CCLK Rising (EDO)	2.0	5.2	ns	
DQM[7:0]# Valid Delay from CCLK Rising (SDRAM)	2.0	5.2	ns	
SRAS[A,B,C]# Valid Delay from CCLK Rising (SDRAM)	1.5	3.8	ns	
SCAS[A,B,C]# Valid Delay from CCLK Rising (SDRAM)	1.4	3.7	ns	
SWE[A,B,C]# Valid Delay from CCLK Rising (SDRAM)	1.6	4.1	ns	
MA[11:2] Valid Delay from CCLK Rising on first Clock after RAS# asserts	2.3	5.9	ns	
MA[1:0] Valid Delay from CCLK Rising (burst)	2.4	6.2	ns	
MA[11:0] Flow Through Delay from HA for first read cycle	5.0	12.8	ns	
SWE[A,B,C]# Valid Delay from CCLK Rising (EDO)	2.8	7.3	ns	

Table 11. AC Characteristics - Data Timing

Parameter	Min	Max	Unit	Notes
HD Valid Delay from CCLK Rising	1.7	4.4	ns	0pf
HD Setup Time to CCLK Rising	2.9		ns	
HD Hold Time from CCLK Rising	0.7		ns	
MD Valid Delay from CCLK Rising	2.2	5.6	ns	
MD Setup Time to CCLK Rising (SDRAM)	0.6		ns	
MD Setup Time to CCLK Falling (EDO)	2.2		ns	
MD Hold Time from CCLK Rising (SDRAM)	1.2		ns	
MD Hold Time from CCLK Falling (EDO)	3.1		ns	

Table 12. AC Characteristics - PCI Cycle Timing

Parameter	Min	Max	Unit	Notes
AD[31:0] Valid Delay from PCLK Rising (address phase)	5.0	11	ns	50pf
AD[31:0] Valid Delay from PCLK Rising (data phase)	5.0	11	ns	
AD[31:0] Setup Time to CCLK Rising	1.5		ns	
AD[31:0] Hold Time to CCLK Rising	0.8		ns	
CBE[3:0]# Setup Time to CCLK Rising	1.0		ns	
FRAME# Setup Time to CCLK Rising	5.8		ns	
TRDY# Setup Time to CCLK Rising	5.5		ns	
IRDY# Setup Time to CCLK Rising	5.0		ns	
STOP# Setup Time to CCLK Rising	3.8		ns	
DEVSEL# Setup Time to CCLK Rising	4.8		ns	
REQ[3:0]# Setup Time to CCLK Rising	8.7		ns	
CBE[3:0]# Hold Time to CCLK Rising	0.2		ns	
FRAME# Hold Time to CCLK Rising	0.3		ns	
TRDY# Hold Time to CCLK Rising	0.4		ns	
IRDY# Hold Time to CCLK Rising	0.3		ns	
STOP# Hold Time to CCLK Rising	0.8		ns	
DEVSEL# Hold Time to CCLK Rising	0.3		ns	
REQ[3:0]# Hold Time to CCLK Rising	0.8		ns	
CBE[3:0]# Valid Delay from PCLK Rising	2.9	7.5	ns	
FRAME# Valid Delay from PCLK Rising	2.8	7.3	ns	
TRDY# Valid Delay from PCLK Rising	5.8	15.0	ns	
IRDY# Valid Delay from PCLK Rising	2.9	7.5	ns	
STOP# Valid Delay from PCLK Rising	2.9	7.5	ns	
DEVSEL# Valid Delay from PCLK Rising	2.8	7.3	ns	
GNT[3:0]#, Valid Delay from PCLK Rising	2.3	6.0	ns	
CBE[3:0]# ,Float Delay from CCLK Rising	3.4	8.7	ns	
FRAME# ,Float Delay from CCLK Rising	3.4	9.8	ns	
TRDY# ,Float Delay from CCLK Rising	3.8	10.0	ns	
IRDY# ,Float Delay from CCLK Rising	3.9	10.0	ns	
STOP# ,Float Delay from CCLK Rising	3.4	9.8	ns	
DEVSEL# ,Float Delay from CCLK Rising	3.8	9.9	ns	

Table 13. AC Characteristics – PCI-66 Cycle Timing

Parameter	Min	Max	Unit	Notes
AD[31:0] Valid Delay from CCLK Rising (address phase)	3.1	5.4	ns	0pf
AD[31:0] Valid Delay from CCLK Rising (data phase)	3.1	5.4	ns	
AD[31:0] Setup Time to CCLK Rising	1.4		ns	
AD[31:0] Hold Time to CCLK Rising	0.3		ns	
CBE[3:0]# Setup Time to CCLK Rising	0.9		ns	
FRAME# Setup Time to CCLK Rising	4.0		ns	
TRDY# Setup Time to CCLK Rising	2.0		ns	
IRDY# Setup Time to CCLK Rising	4.5		ns	
STOP# Setup Time to CCLK Rising	2.7		ns	
DEVSEL# Setup Time to CCLK Rising	4.4		ns	
CBE[3:0]# Hold Time to CCLK Rising	0.4		ns	
FRAME# Hold Time to CCLK Rising	0.6		ns	
TRDY# Hold Time to CCLK Rising	0.4		ns	
IRDY# Hold Time to CCLK Rising	0.2		ns	
STOP# Hold Time to CCLK Rising	0.7		ns	
DEVSEL# Hold Time to CCLK Rising	0.4		ns	
CBE[3:0]# Valid Delay from CCLK Rising	2.1	5.3	ns	
FRAME# Valid Delay from CCLK Rising	2.1	5.2	ns	
TRDY# Valid Delay from CCLK Rising	2.1	5.3	ns	
IRDY# Valid Delay from CCLK Rising	2.1	5.4	ns	
STOP# Valid Delay from CCLK Rising	2.1	5.2	ns	
DEVSEL# Valid Delay from CCLK Rising	2.1	5.6	ns	
GNT#, Valid Delay from CCLK Rising	2.5	5.2	ns	
CBE[3:0]# ,Float Delay from CCLK Rising	3.3	11	ns	
FRAME# ,Float Delay from CCLK Rising	1.7	7	ns	
TRDY# ,Float Delay from CCLK Rising	1.7	7	ns	
IRDY# ,Float Delay from CCLK Rising	3.3	11	ns	
STOP# ,Float Delay from CCLK Rising	1.7	7	ns	
DEVSEL# ,Float Delay from CCLK Rising	2.1	8	ns	

Table 14. AC Characteristics - AGP (1X) Cycle Timing

Parameter	Min	Max	Unit	Notes
GD[31:0] Valid delay from CCLK Rising (request phase)	1.1	5.2	ns	0 pf
GD[31:0] Valid delay from CCLK Rising (data phase)	0.2		ns	
GD[31:0] Valid delay from CCLK Rising (data phase)	2.0	5.0	ns	
GD[31:0] Hold Time to CCLK Rising	0.6		ns	
GBE[3:0]#, Setup Time to CCLK Rising	5.0		ns	
GPIPE#, Setup Time to CCLK Rising	3.6		ns	
SBA[7:0], Setup Time to CCLK Rising	4.7		ns	
GIRDY#, Setup Time to CCLK Rising	4.7		ns	
GRBF#, Setup Time to CCLK Rising	4.7		ns	
CBE[3:0]#, Hold Time from CCLK Rising	0.8		ns	
GPIPE#, Hold Time from CCLK Rising	0.3		ns	
SBA[7:0], Hold Time from CCLK Rising	0.2		ns	
GIRDY#, Hold Time from CCLK Rising	0.3		ns	
GRBF#, Hold Time from CCLK Rising	0.1		ns	
ST[2:0], valid Delay from CCLK Rising	2.4	5.5	ns	
GTRDY#, Valid Delay from CCLK Rising	2.6	5.7	ns	
RREQ# Setup Time to CCLK Rising	3.5		ns	
GREQ# Hold Time to CCLK Rising	0.3		ns	
GGNT# Valid Delay from CCLK Rising	1.5	5.5	ns	

Table 15. AC Characteristics - AGP (2X) Cycle Timing

Parameter	Min	Max	Unit	Notes
GD[31:0] Setup Time to GDS[1:0]#	0.4		ns	0 pf
GBE[3:0]# Setup Time to GDS[1:0]#	0.4		ns	
SBA[7:0] Setup Time to SBS#	0.7		ns	
GDS[1:0]# to CCLK Rising (T2) Setup Time	0.7		ns	
SBS# to CCLK Rising Setup Time	0.7		ns	
GD[31:0] Hold Time from to GDS[1:0]# falling	0.7		ns	
GBE[3:0]# Hold Time from to GDS[1:0]# falling	0.7		ns	
SBA[7:0] Hold Time from to SBS# falling	0.4		ns	
GDS[1:0]# to CCLK Rising (T2) Hold Time	1.5		ns	
SBS# to CCLK Rising Hold Time	1.5		ns	
GD[31:0] Valid Delay before GDS[1:0]#	1.8	3.7	ns	
GD[31:0] Valid Delay after GDS[1:0]#	1.8	3.8	ns	
GD[31:0] Float to Active Delay	2.0	5.2	ns	
GD[31:0] Active to Float Delay	1.7	4.4	ns	
GDS[1:0]# Falling Delay from CCLK Rising	3.4	8.9	ns	
GDS[1:0]# Rising Delay from CCLK Rising	6.0	15.6	ns	

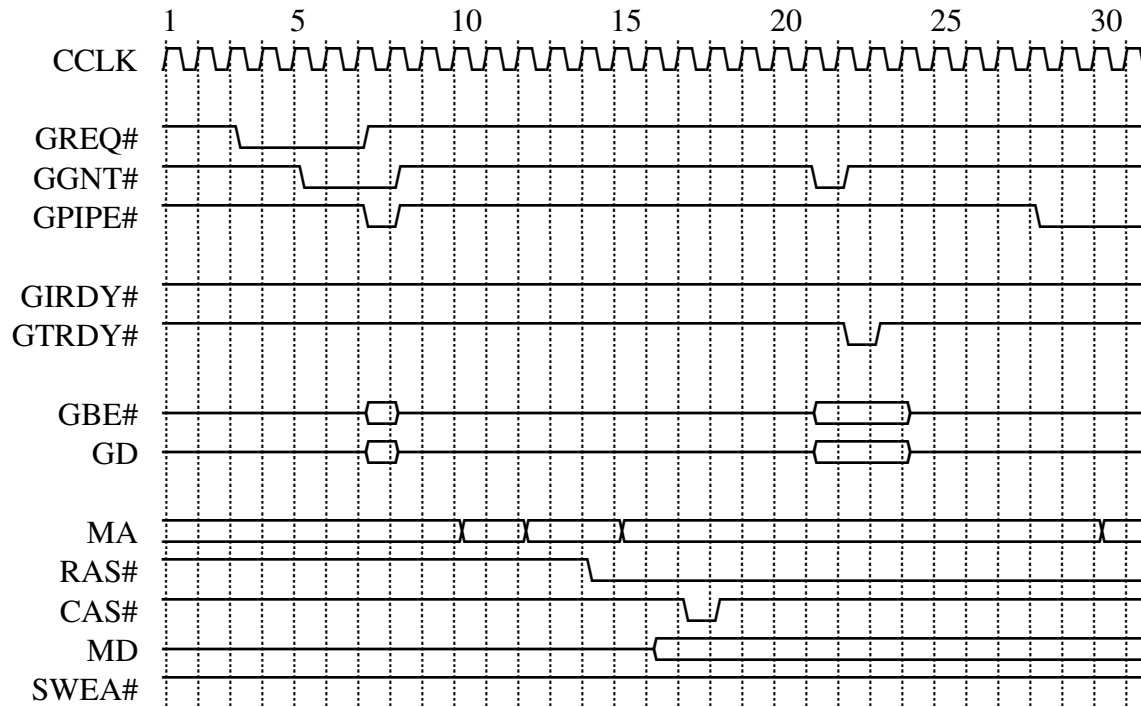

Figure 9. AGP Memory Access (LPR)

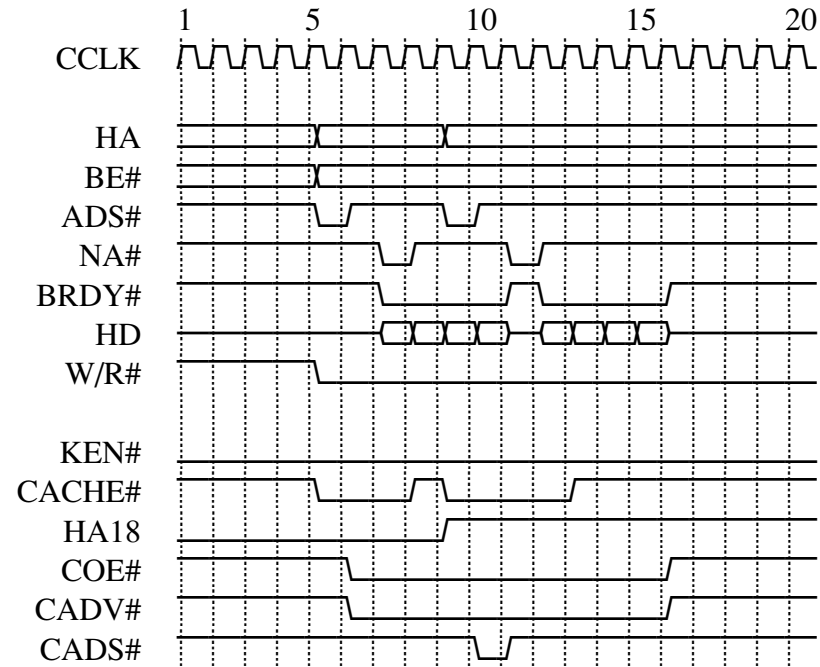

Figure 10. 2-Bank PDSRAM Read 3111-2111

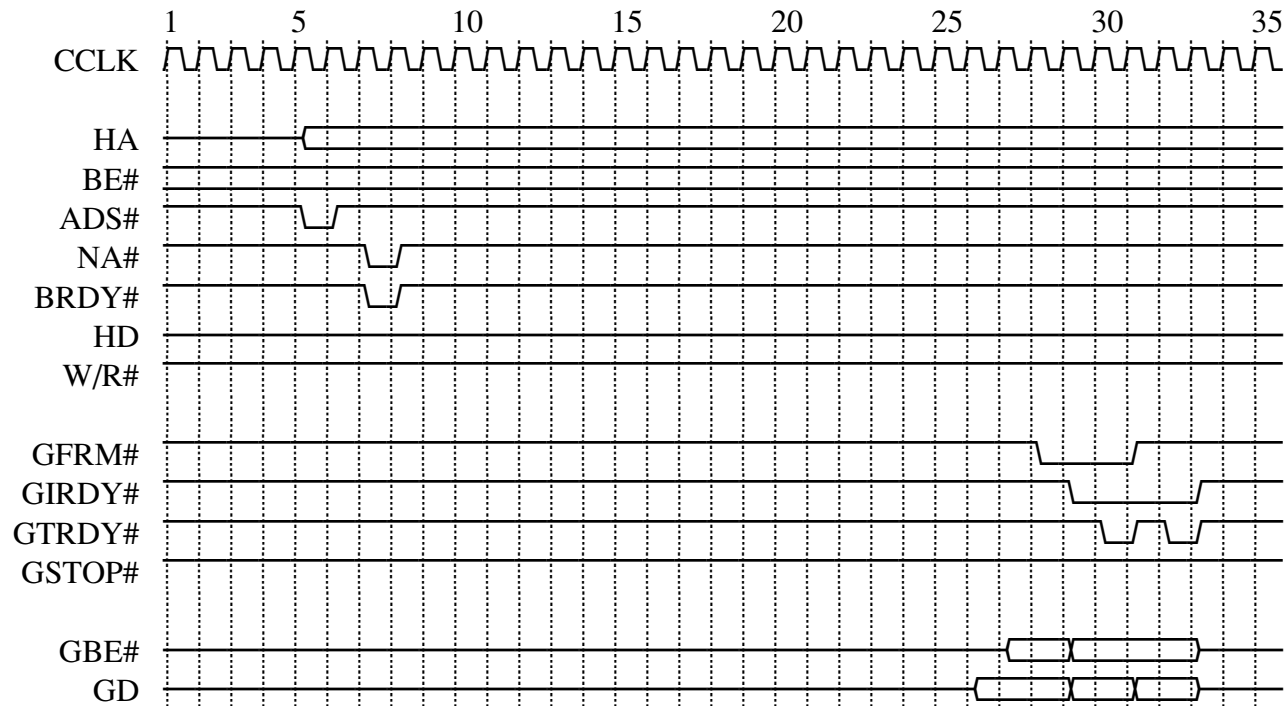

Figure 11. PCI-66 Configuration Cycle

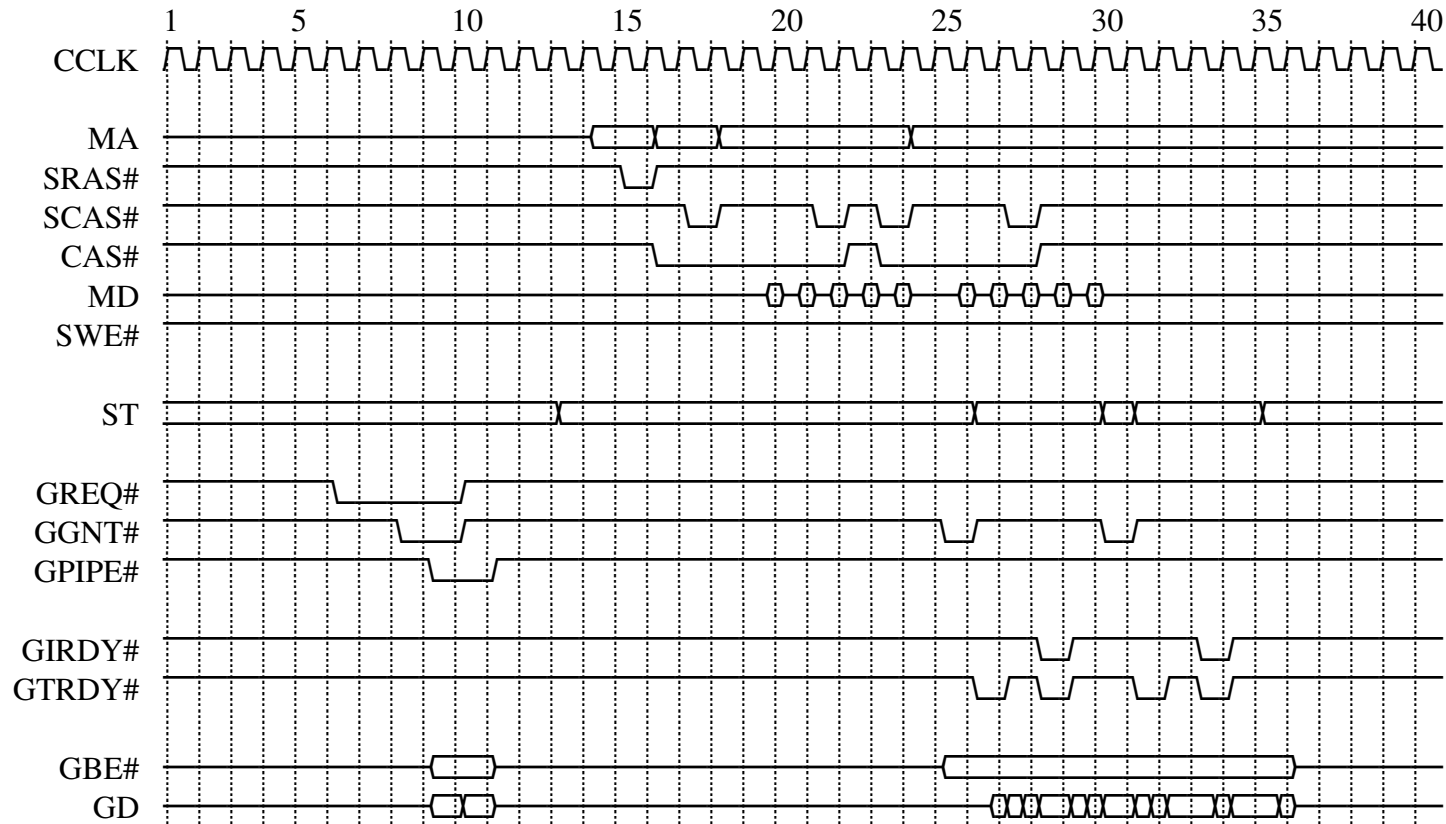

Figure 12. AGP Read SDRAM (2L) 1x Pipe Mode

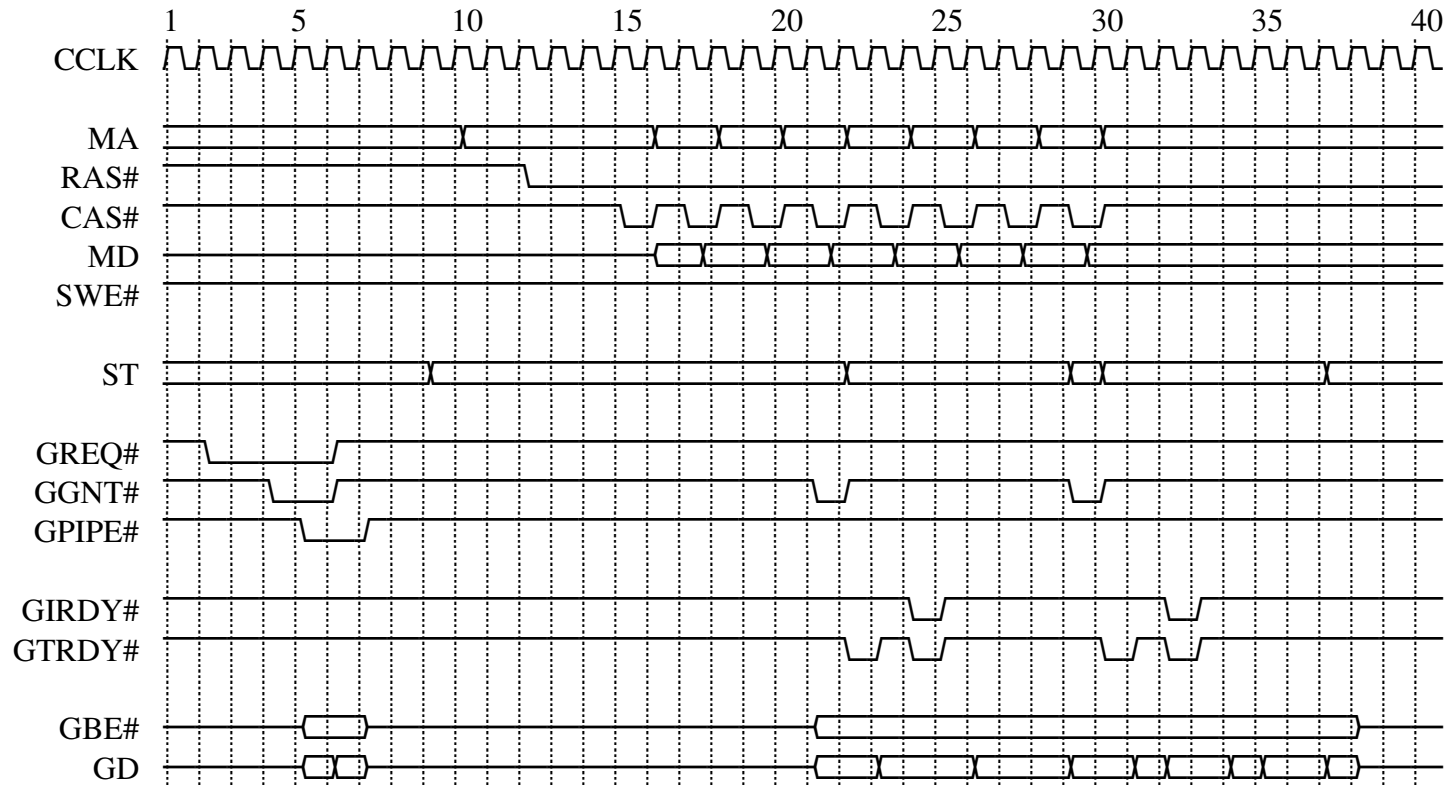

Figure 13. AGP Read EDO 1x Pipe Mode

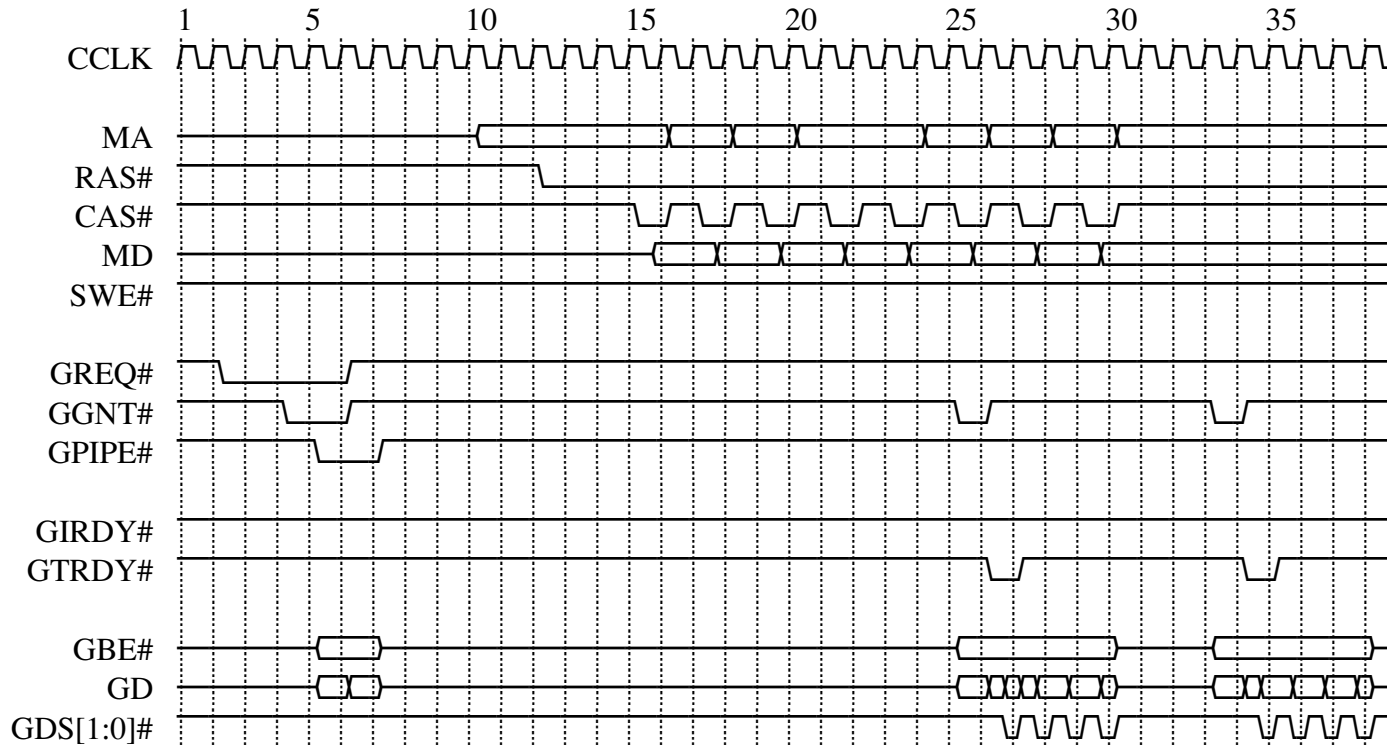

Figure 14. AGP Read EDO PIPE 2x Mode

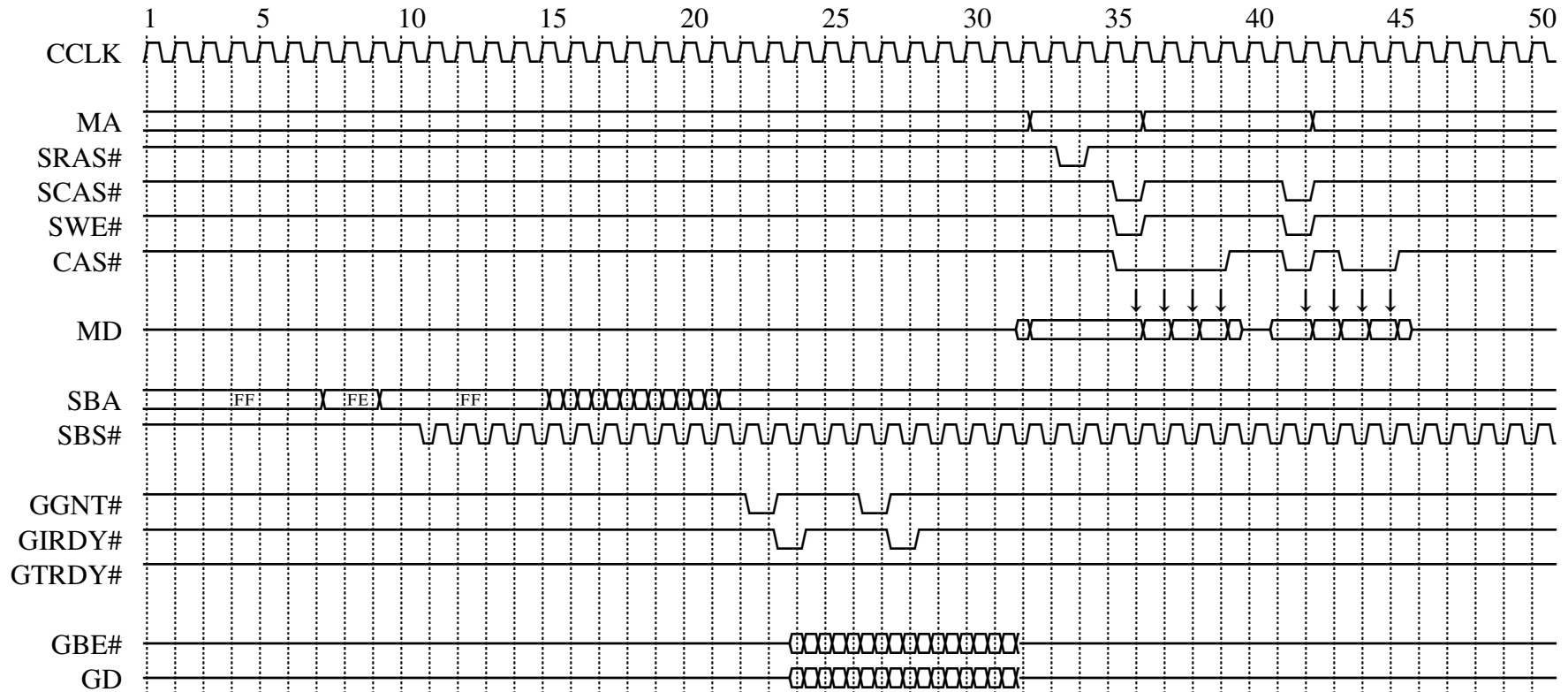

Figure 15. AGP Sideband Address 2x Write SDRAM

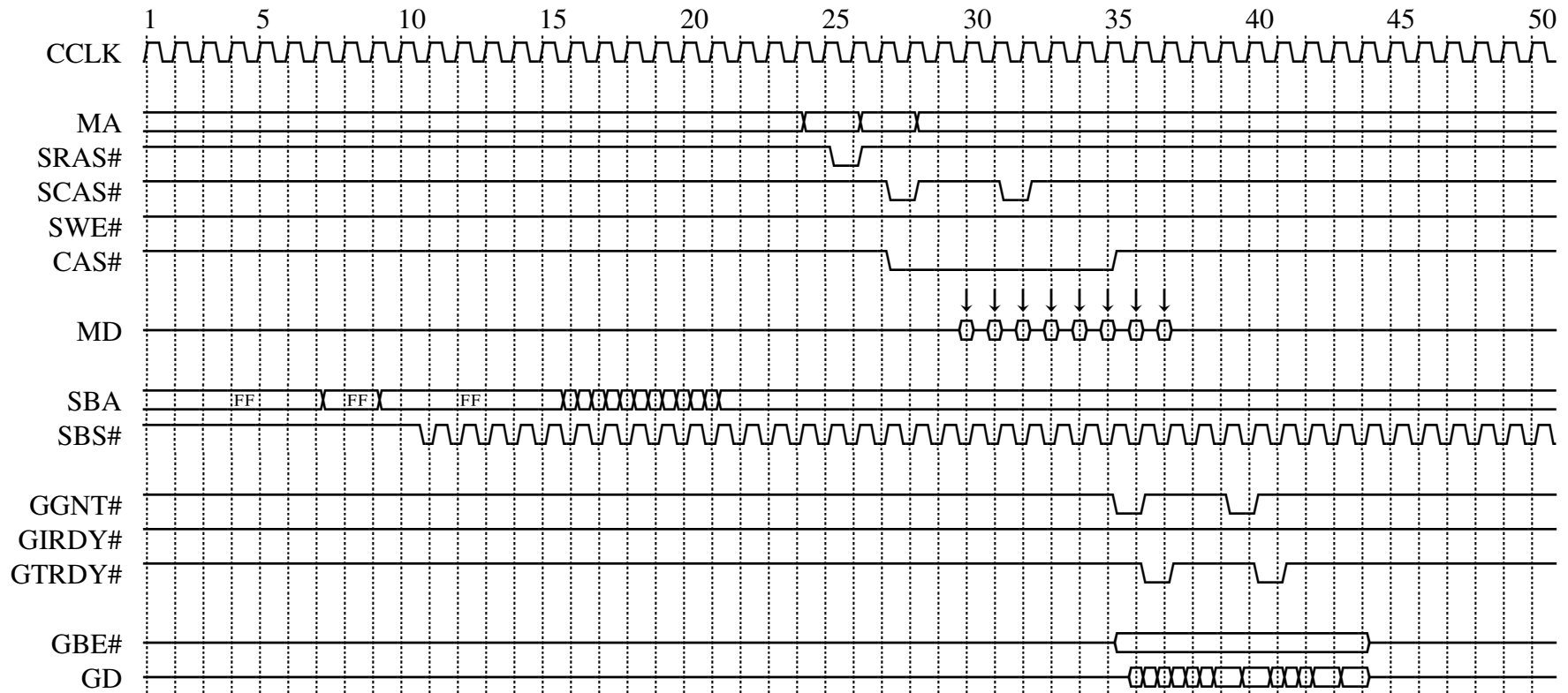

Figure 16. AGP Sideband Address 2x Read SDRAM (2L)

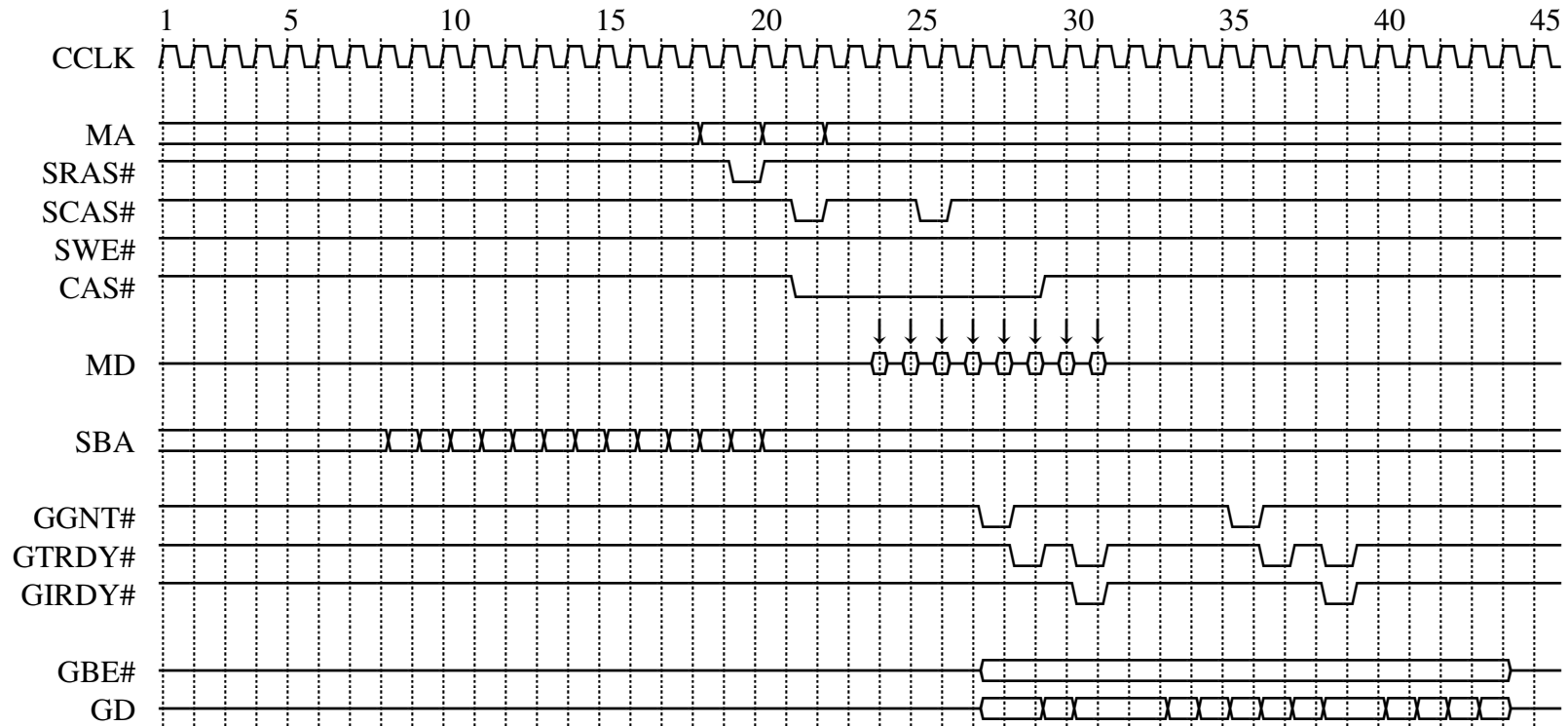

Figure 17. AGP Sideband Address 1x Read SDRAM (2L)

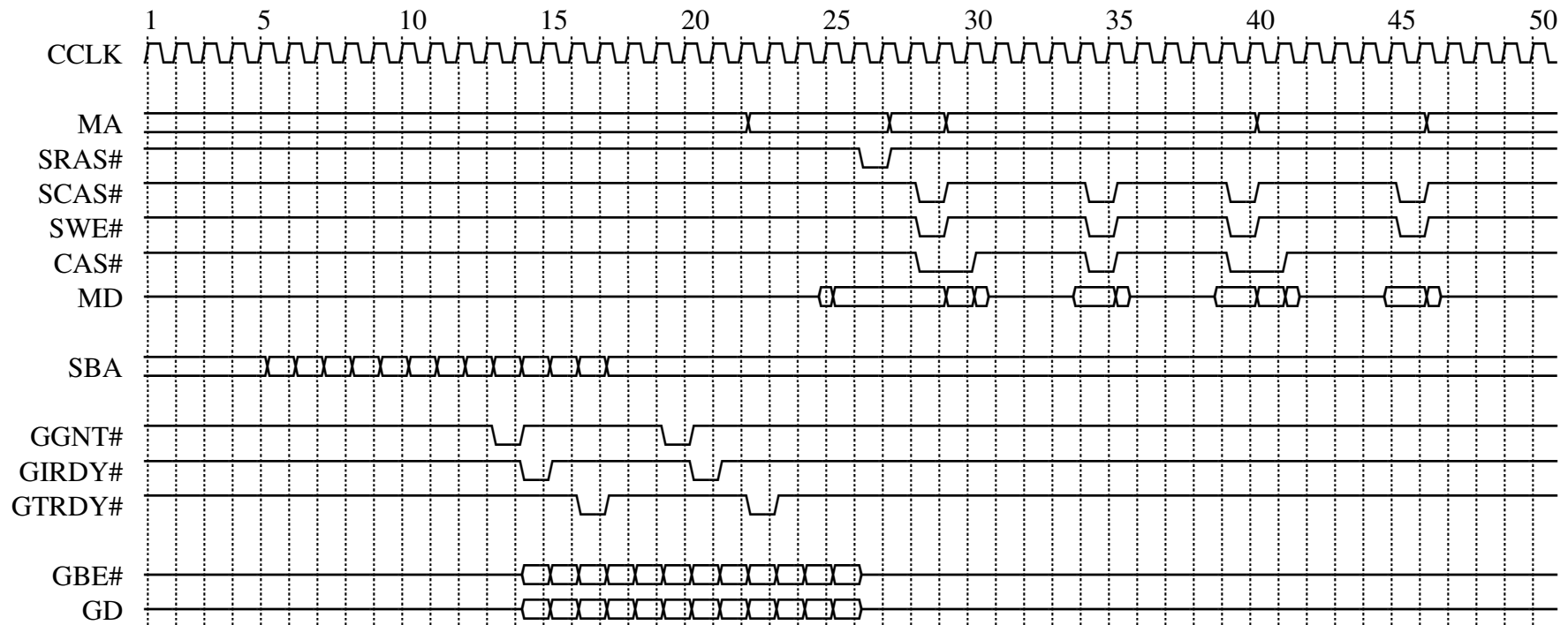

Figure 18. AGP Sideband Address 1x Write SDRAM

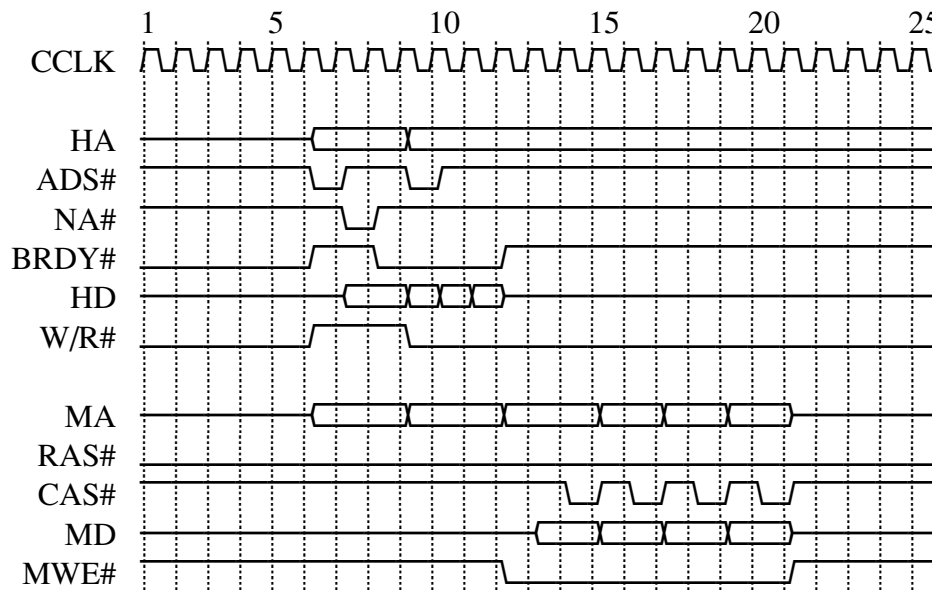

Figure 19. Post Write 3111, EDO DRAM 2222

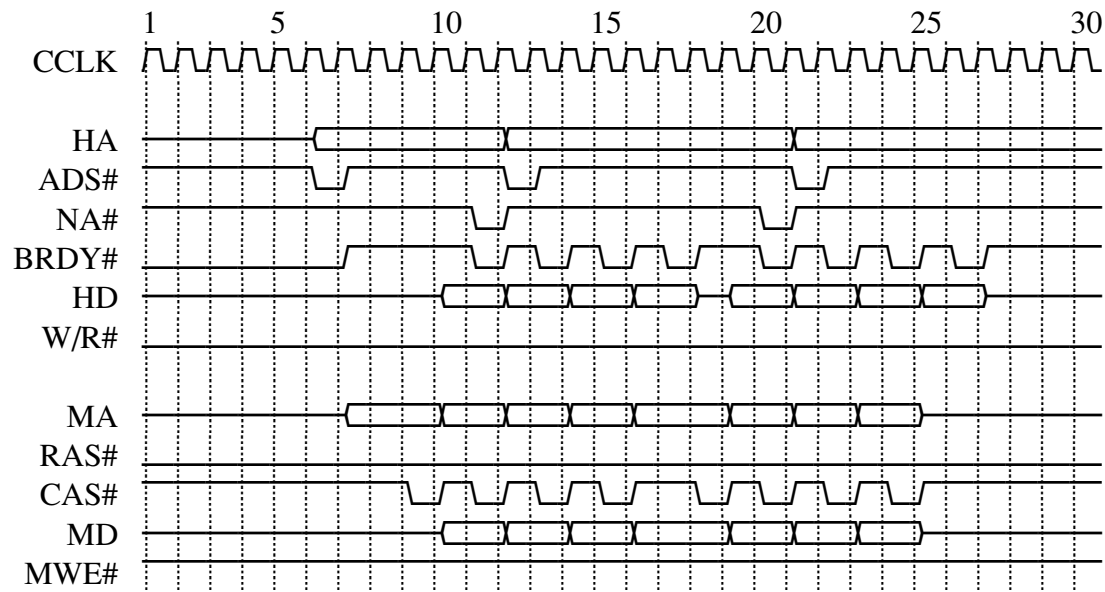

Figure 20. Pipeline Read EDO DRAM 6222, 3222

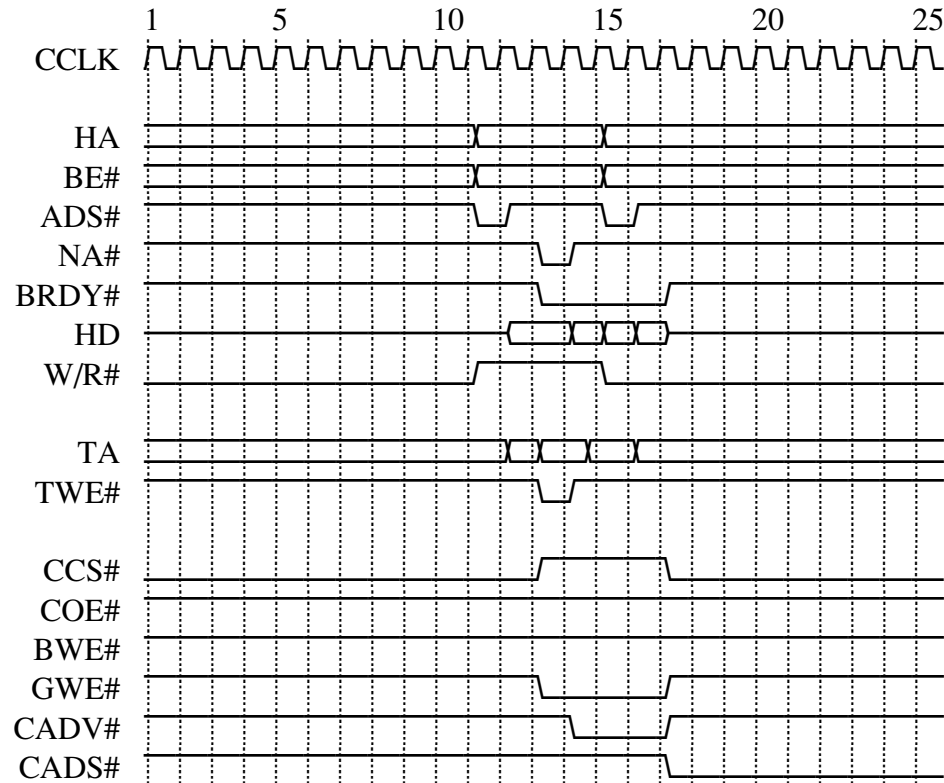

Figure 21. CPU Write Hit SRAM 3111

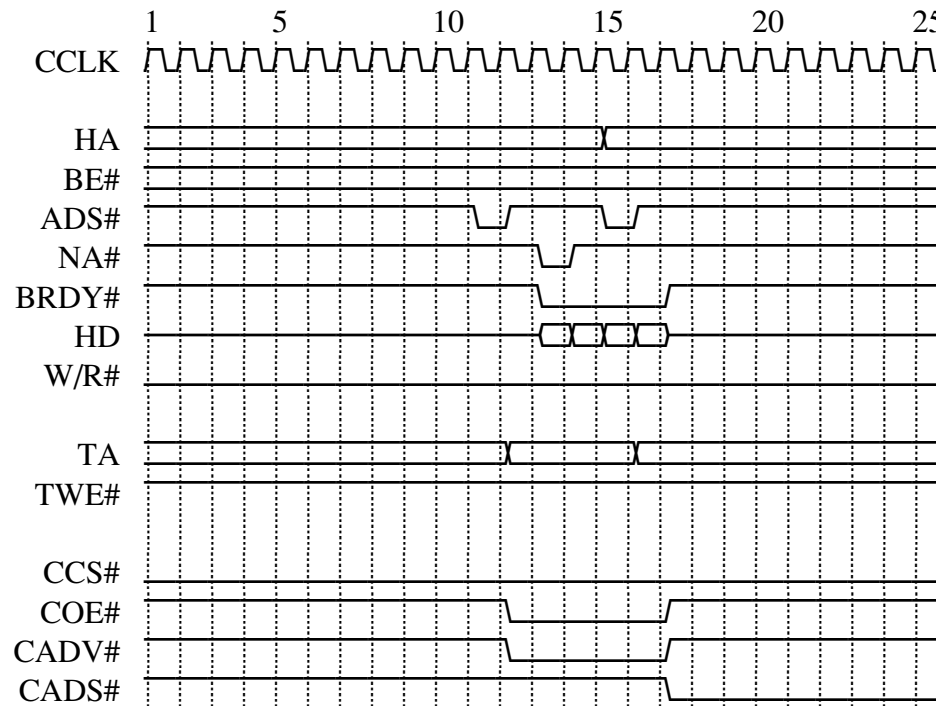

Figure 22. CPU Read Hit SRAM 3111

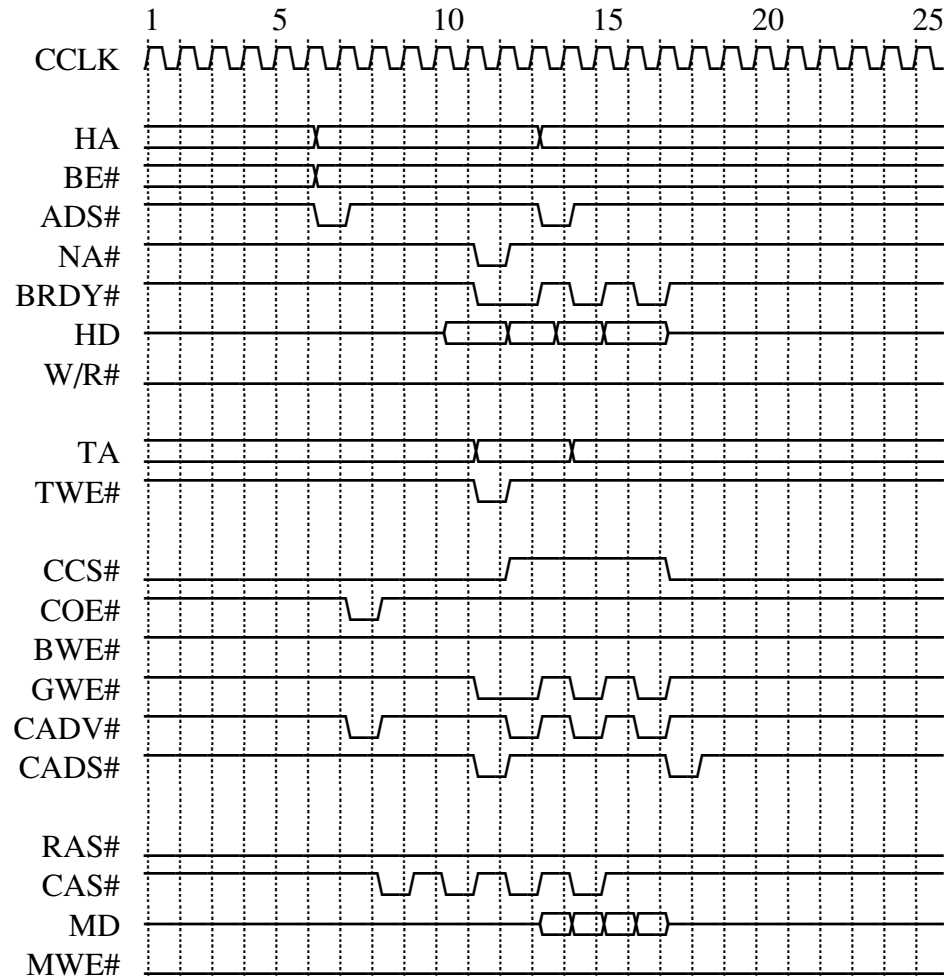

Figure 23. CPU Read Miss Fill Synchronous SRAM

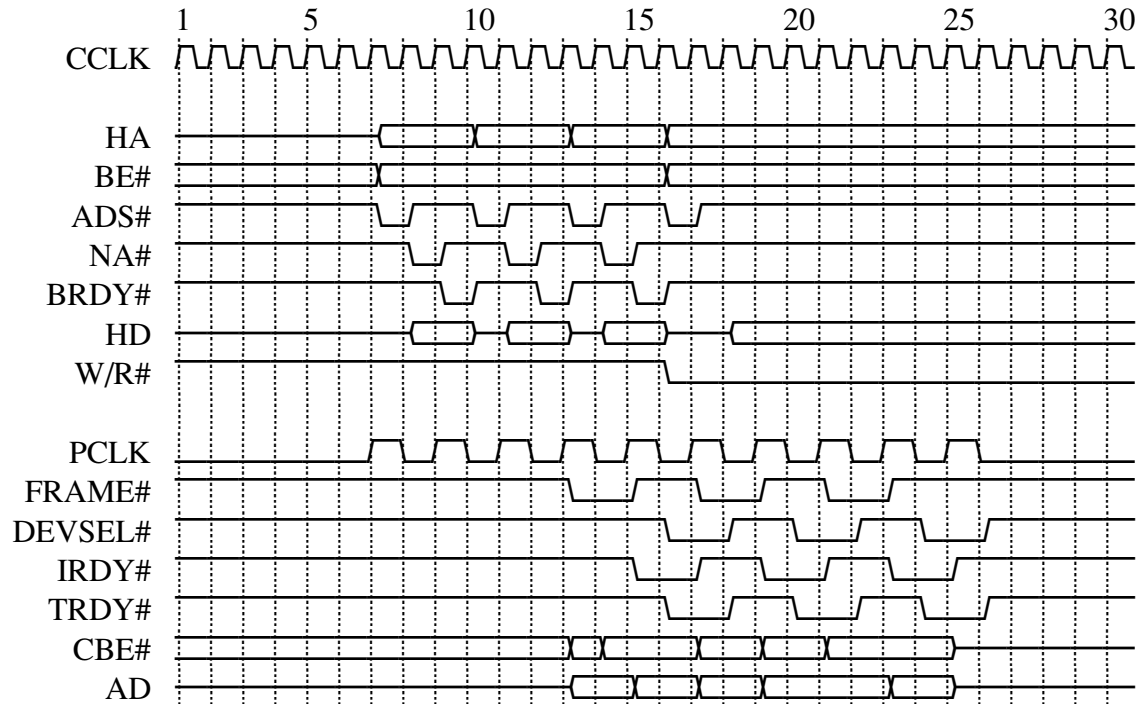

Figure 24. CPU Write PCI Slave Write Buffer on Fast Back-to-Back

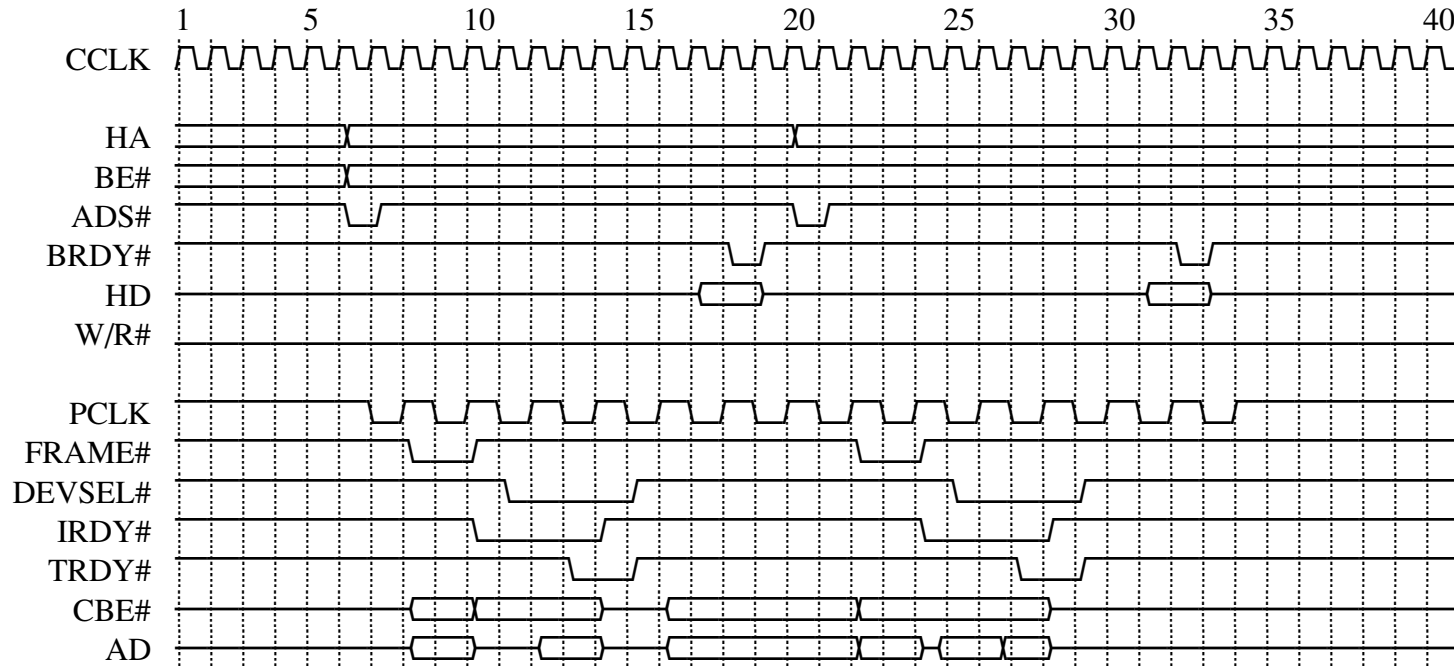

Figure 25. CPU Read PCI Slave

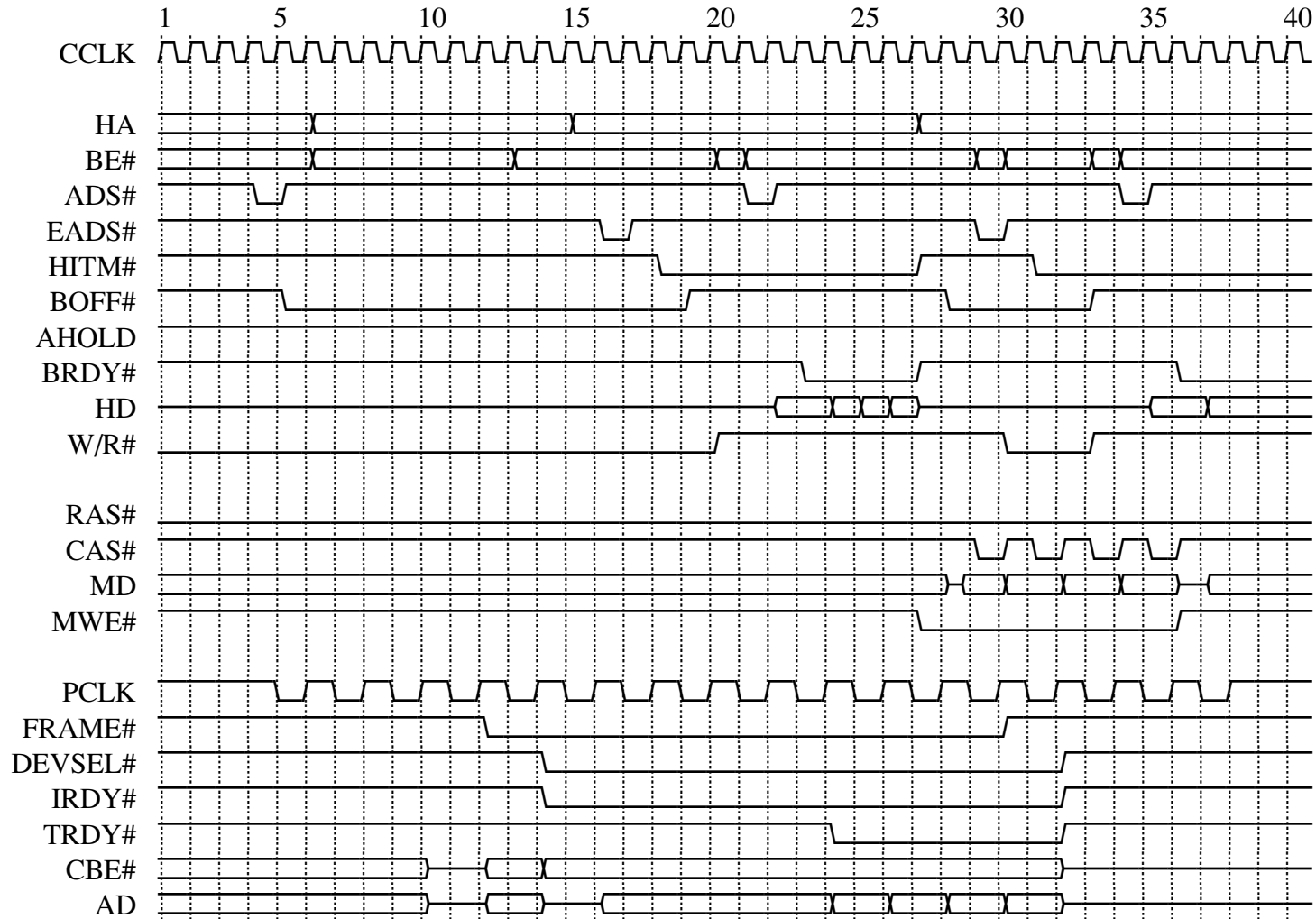

Figure 26. PCI Master Read L1 Snoop to DRAM



Figure 27. PCI Master Read Hit L2

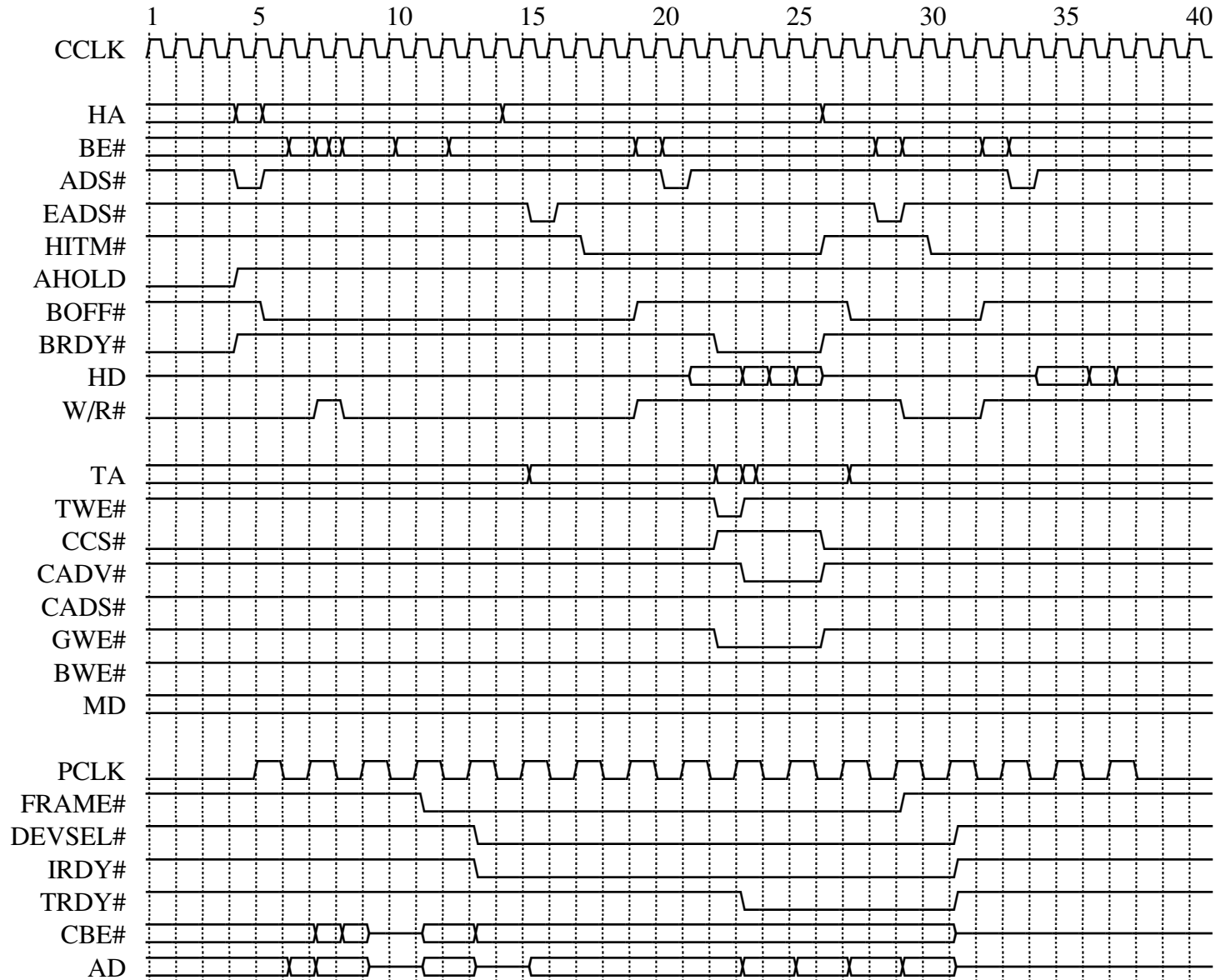

Figure 28. PCI Master Read L1 Snoop to L2

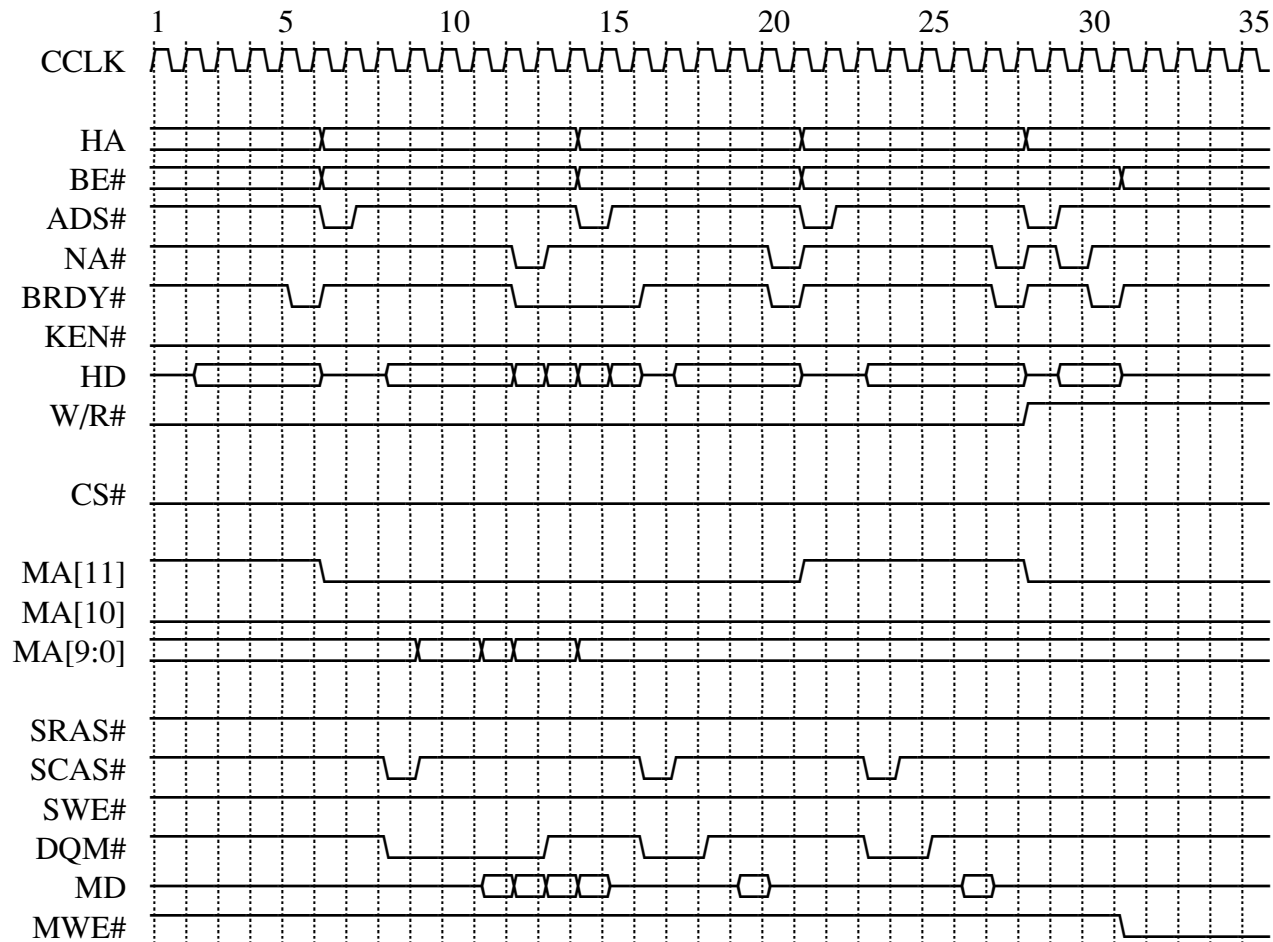

Figure 29. SDRAM Read Cycle (Bank Interleave, CAS Latency 3)

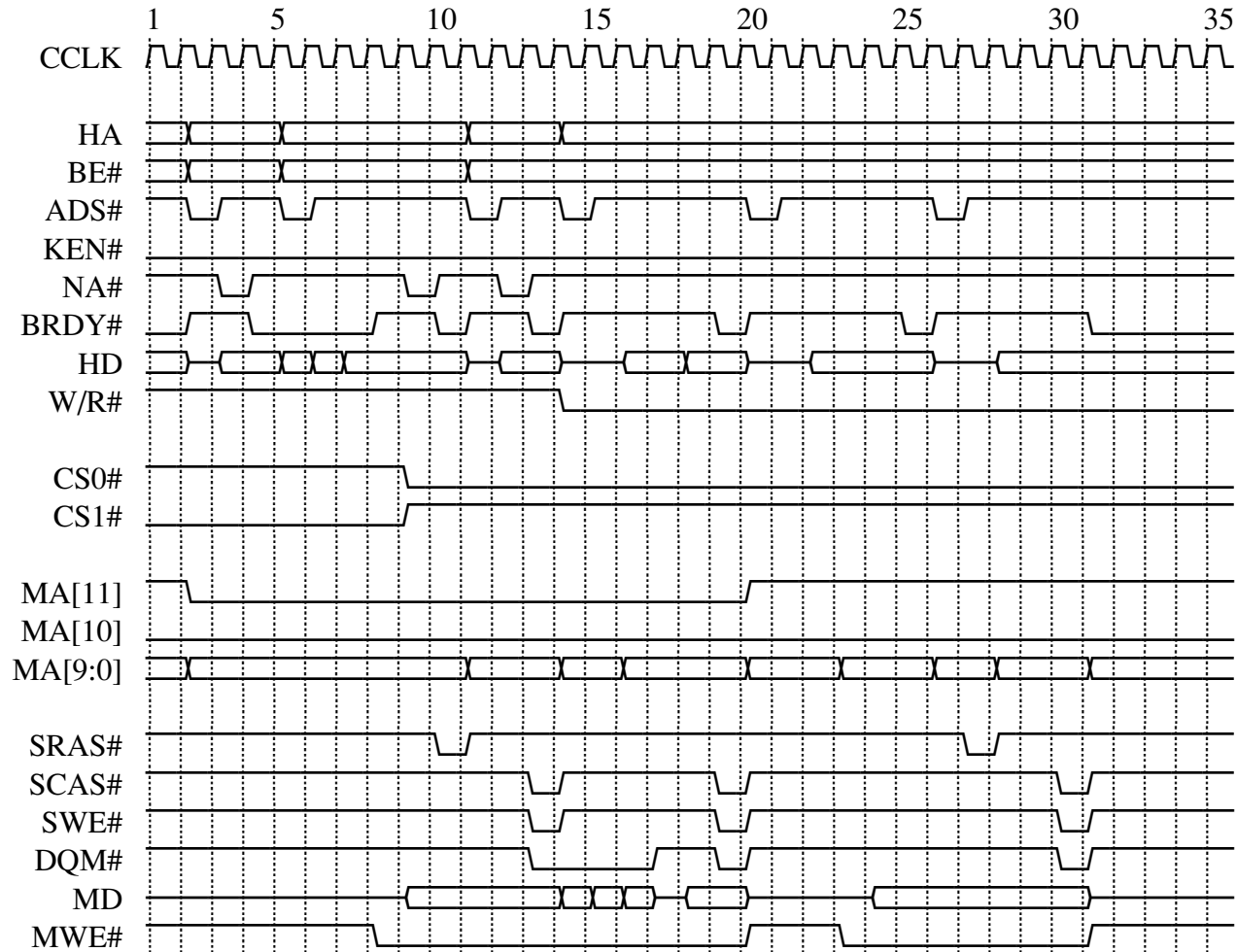

Figure 30. SDRAM Write Cycle (Bank Interleave)

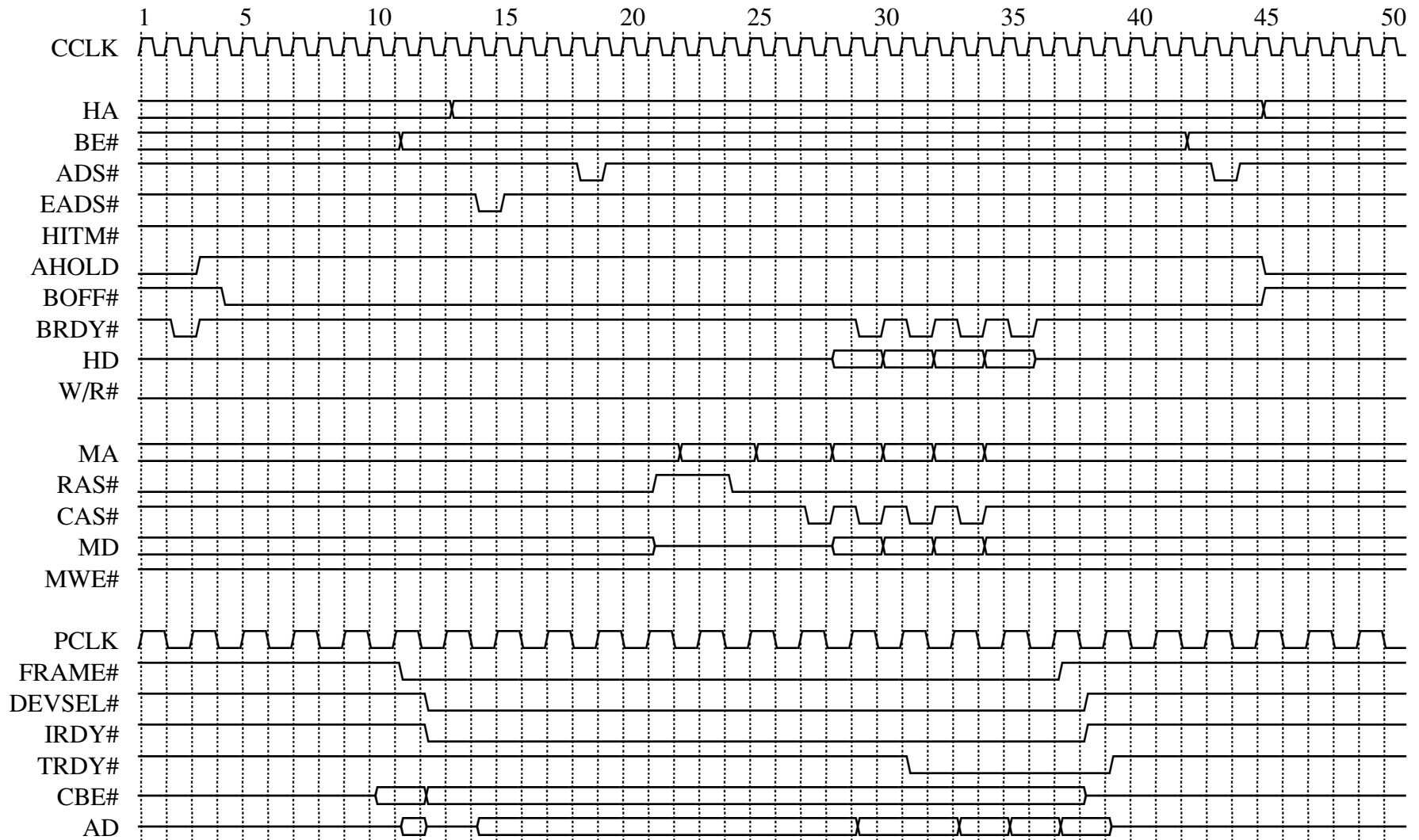

Figure 31. PCI Master Read Hit DRAM

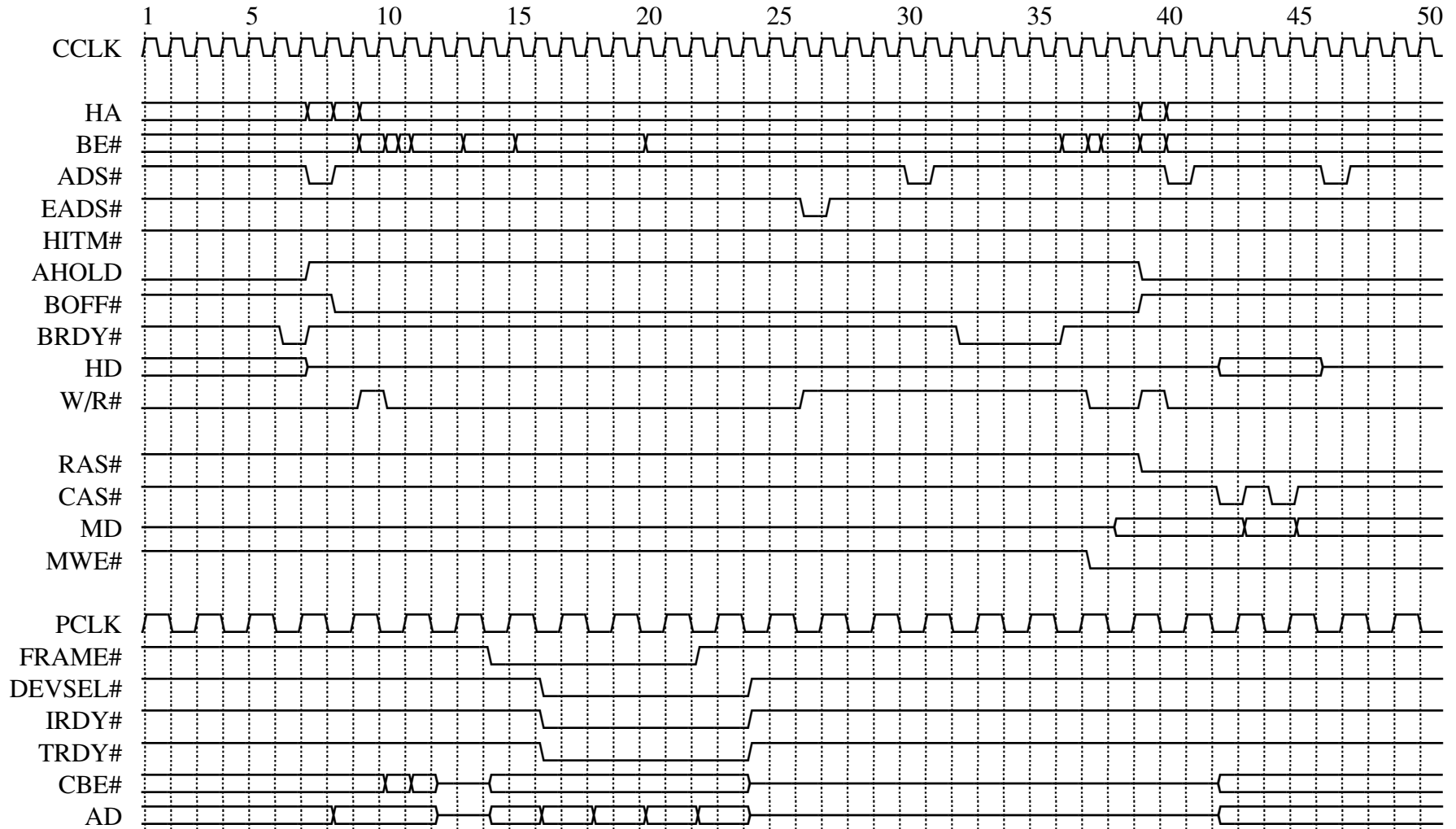

Figure 32. PCI Master Write DRAM

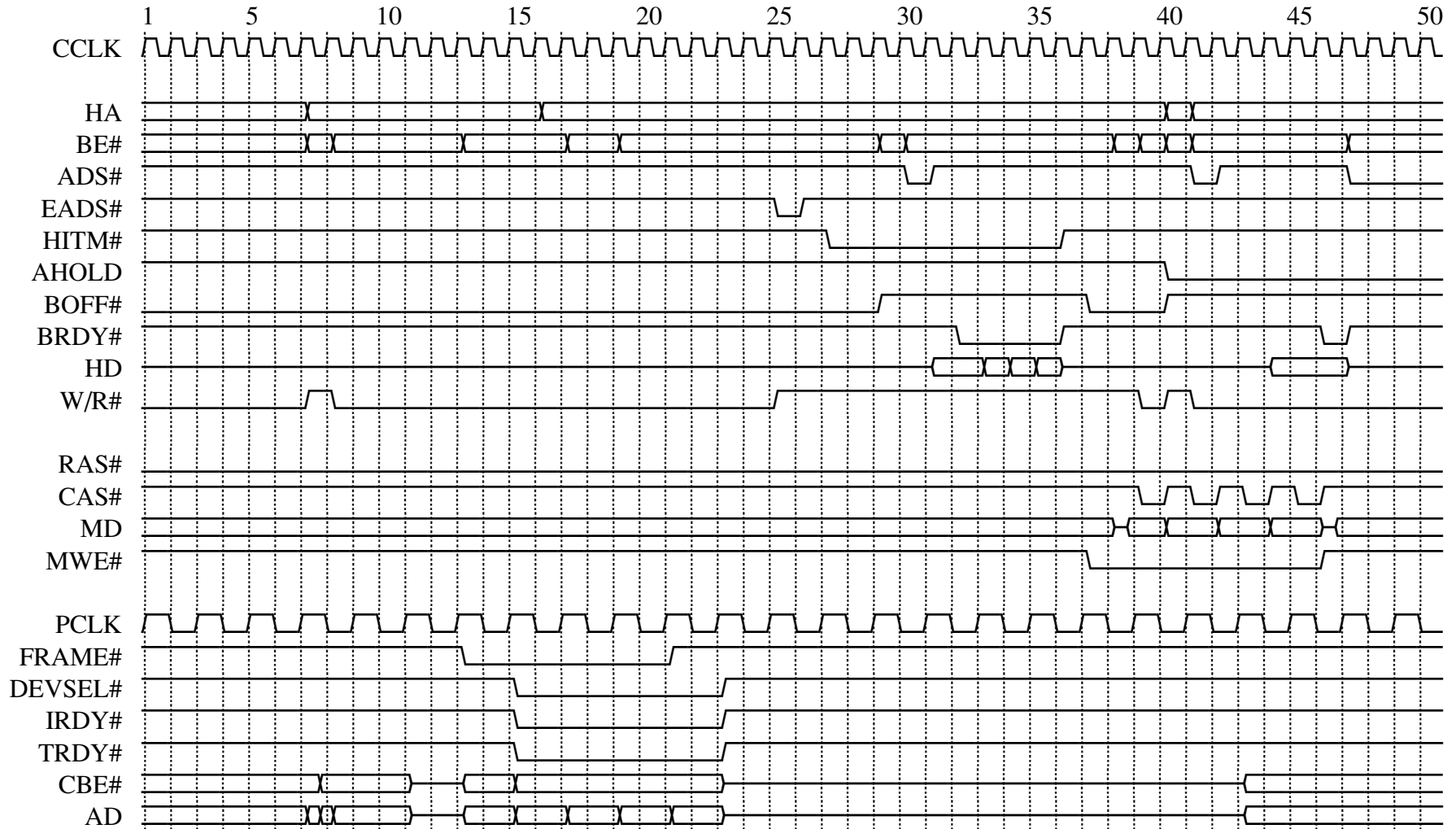

Figure 33. PCI Master Write Hit L1 Snoop to DRAM

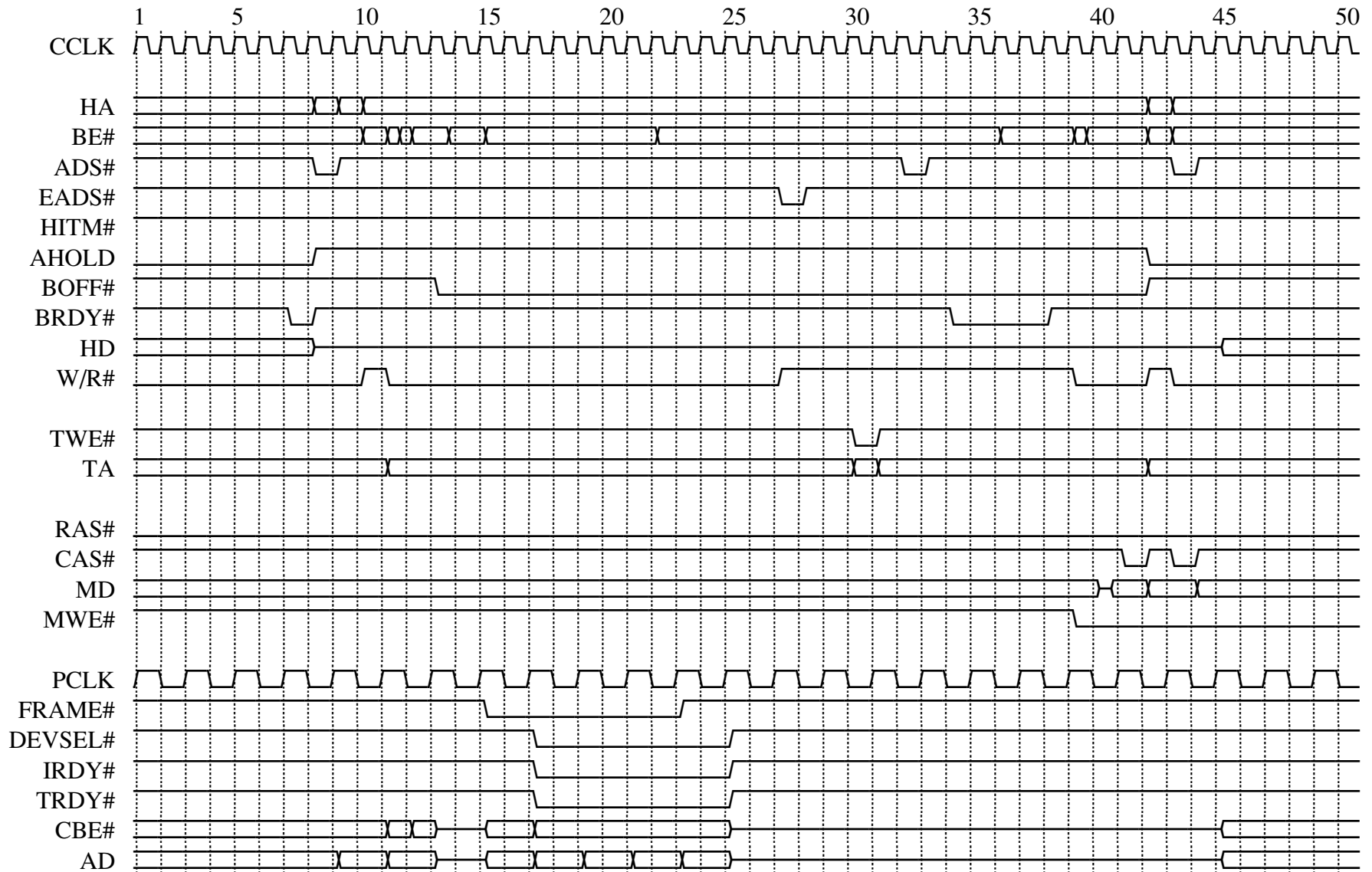

Figure 34. PCI Master Write Hit L2



Figure 35. PCI Master Write Hit L2, L1 HITM

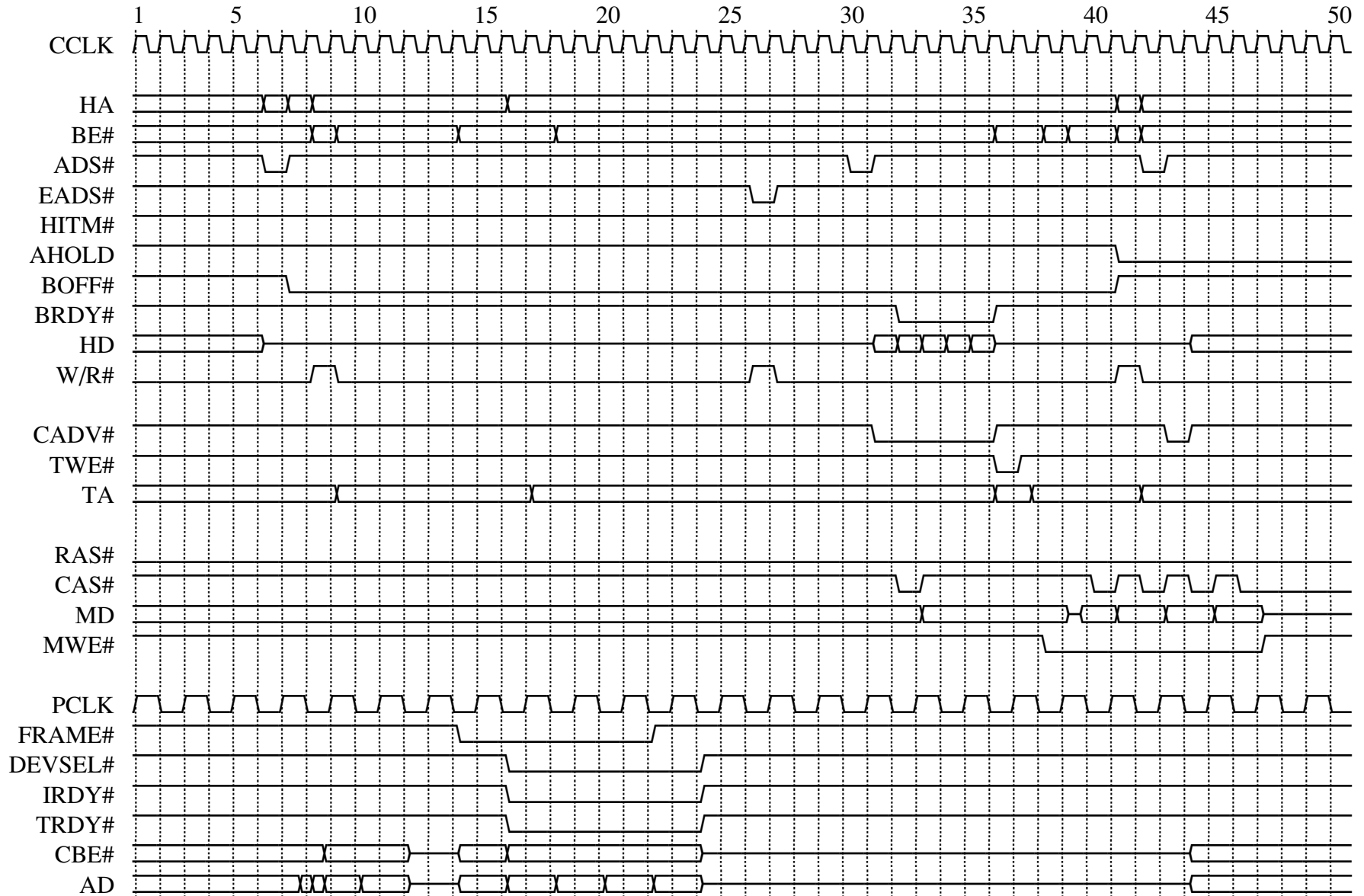

Figure 36. PCI Master Write Hit L2 & Dirty

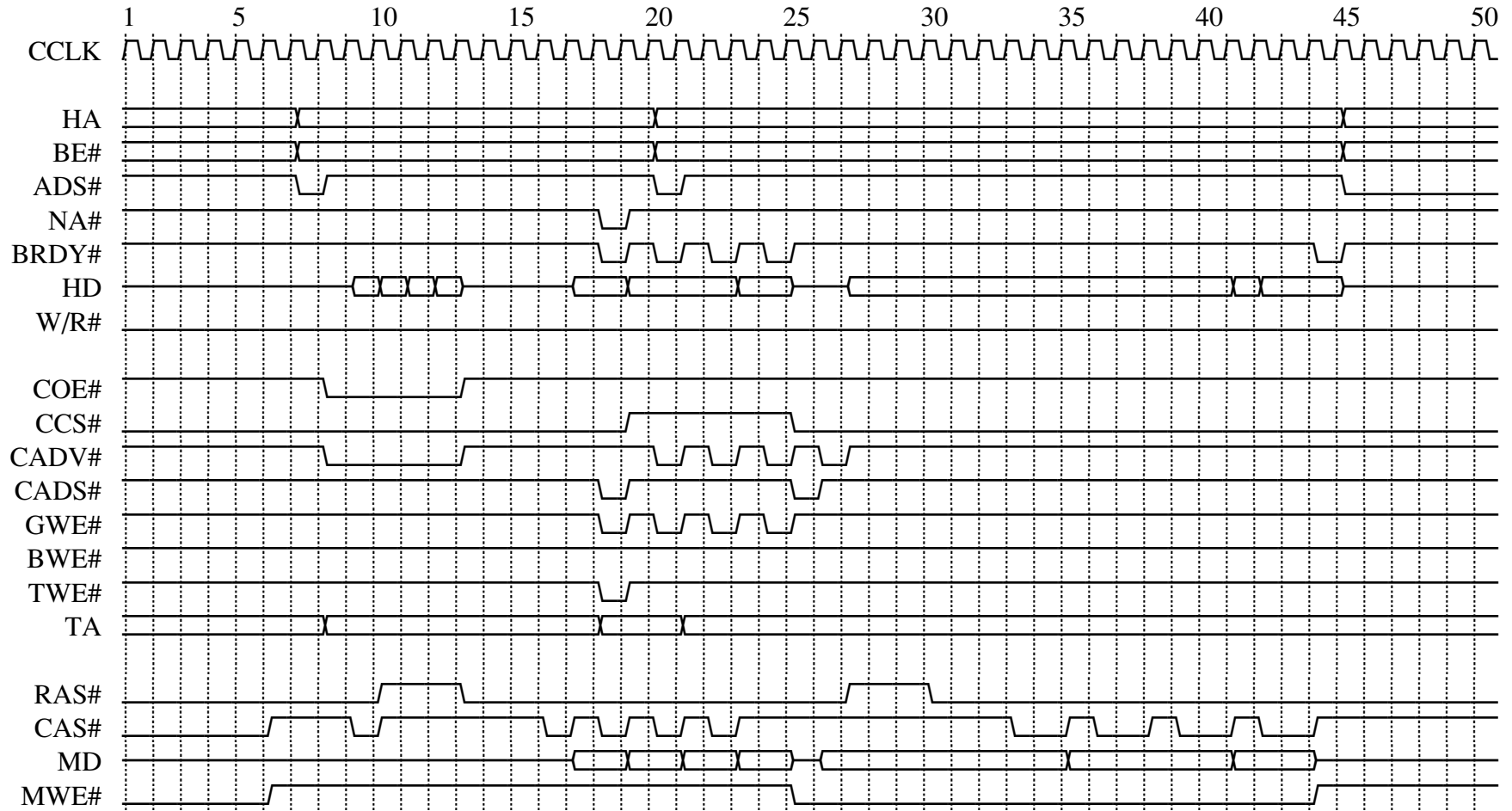

Figure 37. CPU Read Miss Dirty L2 Write Back Fill

MECHANICAL SPECIFICATIONS

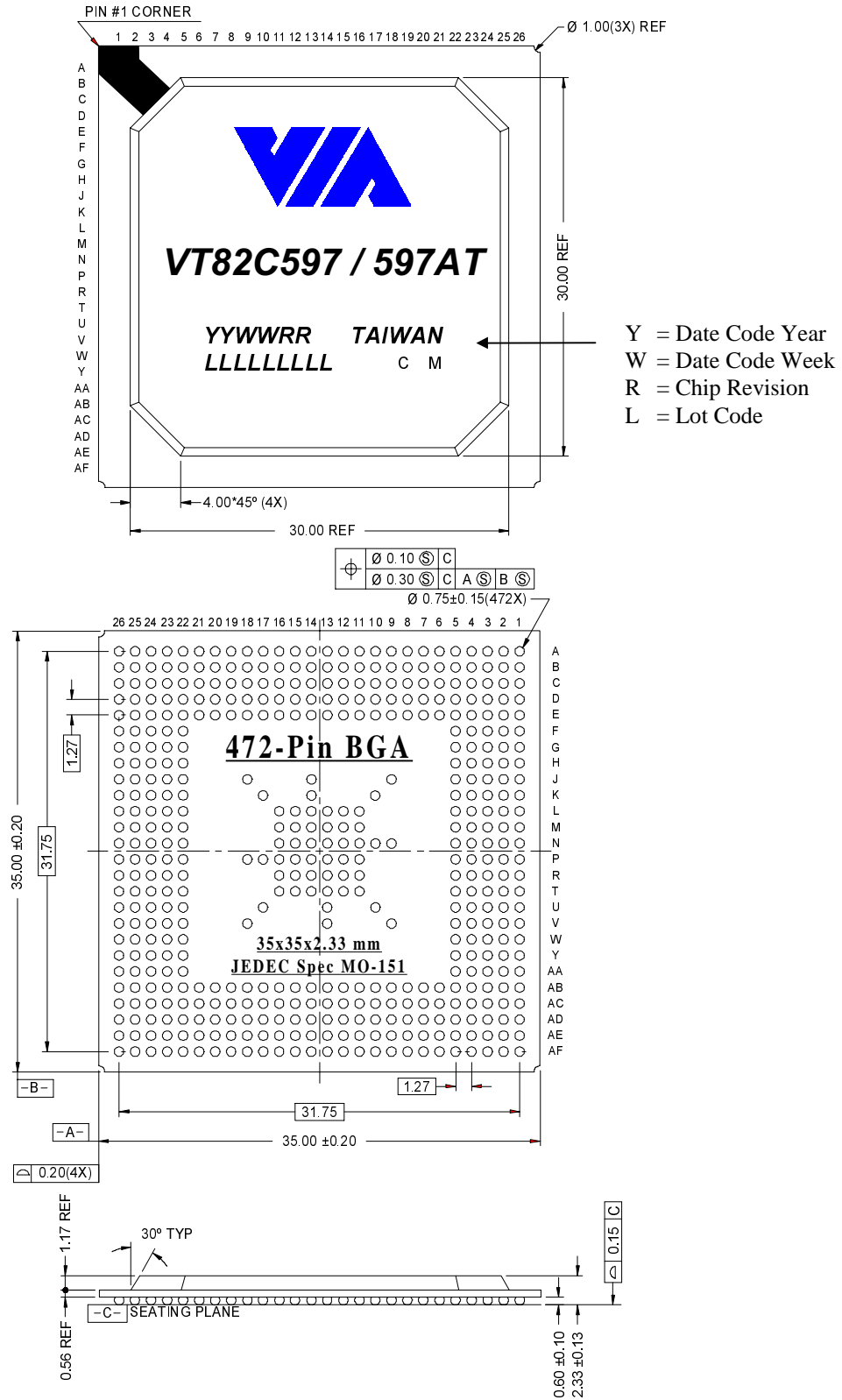

Figure 39. Mechanical Specifications - 472-Pin Ball Grid Array Package