

Description

The VRC4171A™ is a companion chip to NEC's 64-bit VR41xx™ family of MIPS® RISC microprocessors. Together, these two devices form the essential engine for most Windows® CE-based handheld products.

Features

- **Processor Interface**
 - LCD module: *RD, *WR, *LCDCS and LCDRDY signals from the VR41xx
 - Other modules: mini-ISA-like 16-bit bus interface (as defined in the VR41xx)
 - 256 x 18-bit on-chip color palette RAM for STN, DSTN, and TFT color panels
 - On-chip hardware cursor control (32 x 32 x 2)

- **LCD Panel Support**
 - 240- and 480-line single scans
 - 480-line dual scans
 - STN, DSTN, and TFT color panels
 - Nonindexed, true color (R, G, B): 15-bit (5-5-5) and 16-bit (5-6-5)
 - Controller functions (320 x 240, 480 x 240, 640 x 240, and 640 x 480)
 - Monochrome: up to 16 gray-scale levels (1, 2, or 4 bits/pixel)
 - Color depth: 1, 2, 4, 5, 6, 8, or 16 bits/pixel

- **Frame Buffer Memory**
 - One or two 3.3-volt 256K x 16-bit DRAMs (512K or 1 MB)
 - One 1 MB x 16-bit DRAM (2 MB)

- **PC Card™ Slots (up to two)**
 - PC Card or CompactFlash™ with adapter
 - PC Card or CompactFlash or Miniature Card™
 - PC Card controller: compliant with ExCA and PCMCIA release 2.1
 - CompactFlash controller: compliant with release 1.1
 - Miniature Card controller: compliant with release 1 (flash/ROM only)

- **Other Features**
 - Up to four general-purpose I/O (GPIO) pins *or* up to two GPIO pins and two PCS pins
 - 5-volt tolerance for LCD panel, frame buffer, and PC Card interface signals
 - 208-pin LQFP package
 - 3.3-volt ±5% operation

Figure 1. Internal Block Diagram

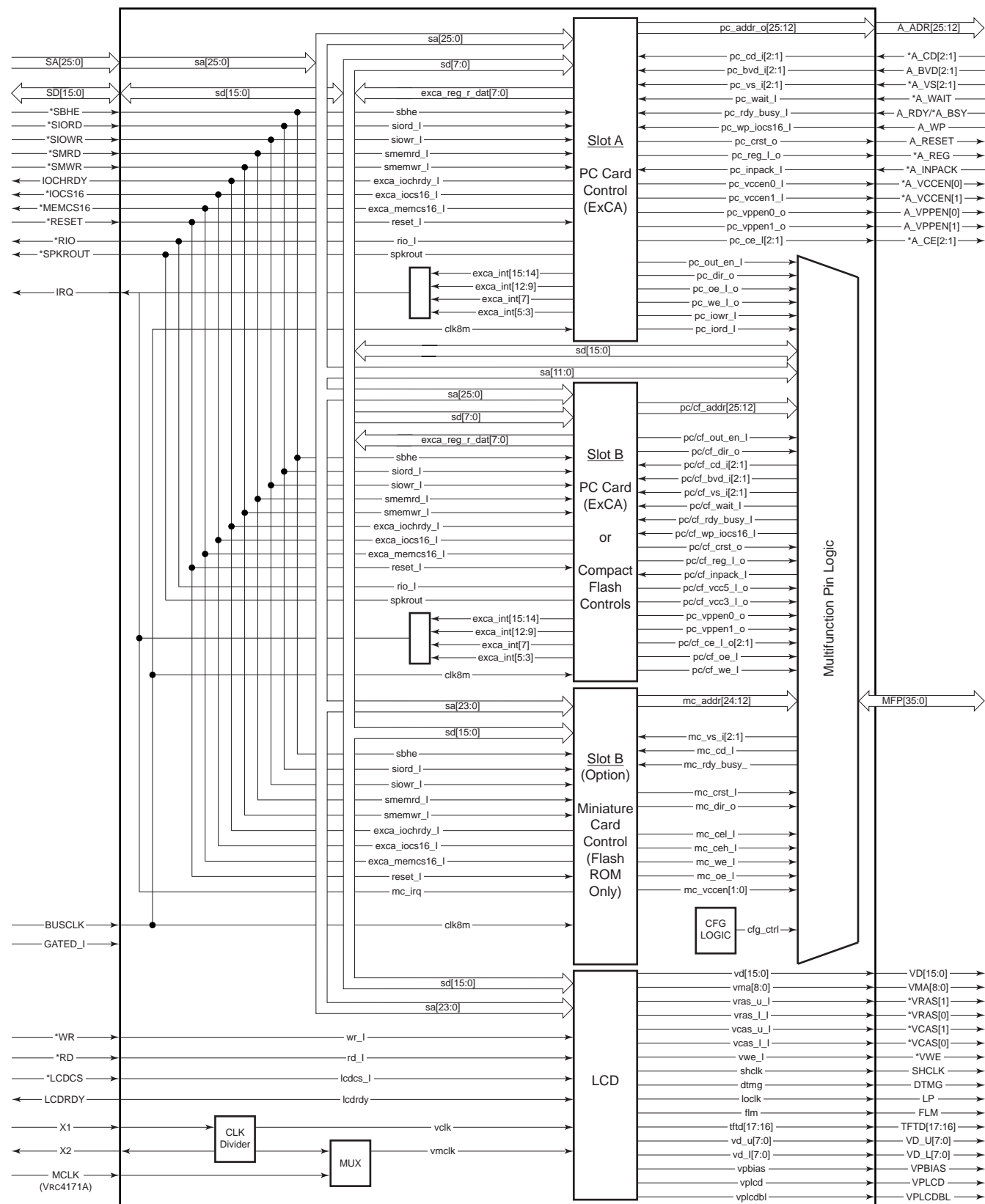
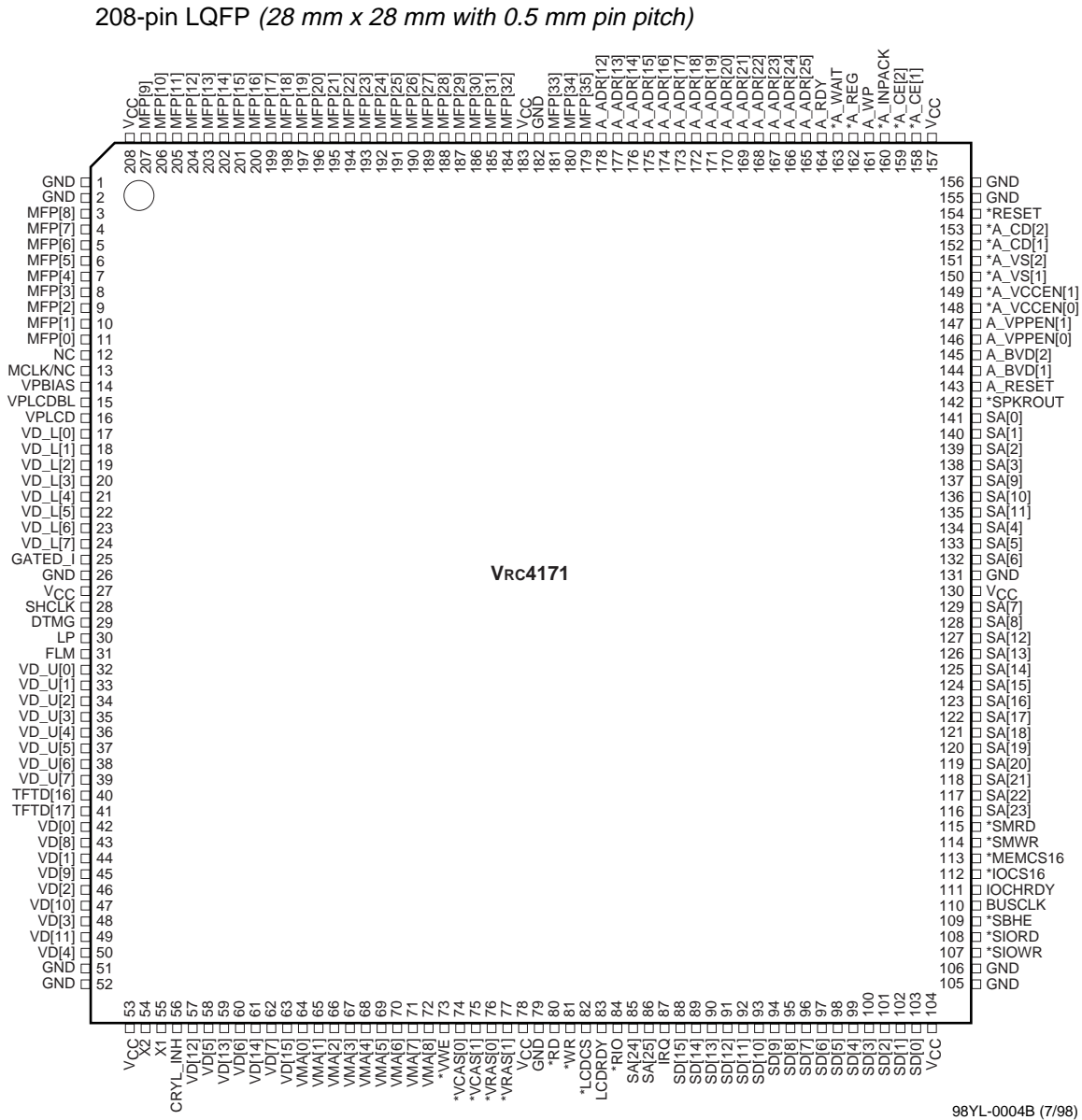

Figure 2. Pin Configuration



Refer to the *Vrc4171A Companion Chip User's Manual* (document no. U13275EU1V0UM00) for a detailed description of pin functions.

Table 1. Absolute Maximum Ratings

Parameter	Specification
Power supply voltage, V_{DD}	-0.5 to +4.6 volts
Input voltage, V_I	
3.3-volt input buffer (at $V_I < V_{DD} + 0.5$ volt)	-0.5 to +4.6 volts
3.3-volt fail-safe buffer (at $V_I < V_{DD} + 0.5$ volt)	-0.5 to +4.6 volts
5-volt tolerant (at $V_I < V_{DD} + 3.0$ volts)	-0.5 to +6.6 volts
Output voltage, V_O	
3.3-volt output buffer (at $V_O < V_{DD} + 0.5$ volt)	-0.5 to +4.6 volts
5-volt tolerant buffer (at $V_O < V_{DD} + 3.0$ volts)	-0.5 to +6.6 volts
5-volt open-drain output buffer (at $V_O < V_{DD} + 3.0$ volts)	-0.5 to +6.6 volts
Latch-up current, I_{LATCH}	>1 A (typical)
Operating temperature, T_{OPT}	-40 to +85°C
Storage temperature, T_{STG}	-65 to +125°C

Caution: Exposure to absolute maximum ratings for extended periods may affect device reliability; exceeding the rating could cause permanent damage. Do not operate the device outside the recommended operating conditions.

Table 2. Recommended Operating Conditions ($V_{DD} = 3.3 V \pm 0.165 V$; $T_A = 0$ to +70°C)

Parameter	Symbol	3.3-Volt Interface Block			5-Volt Interface Block		Unit
		Min.	Typ.	Max.	Min.	Max.	
I/O power supply voltage	V_{DD}	3.135	3.3	3.465			V
Junction temperature	T_j	0		+100	0	+100	°C
High-level input voltage	V_{IH}	2.0		V_{DD}	2.0	5.5	V
Low-level input voltage	V_{IL}	0		0.8	0	0.8	V
Positive trigger voltage	V_P	1.50		2.70	2.20	2.55	V
Negative trigger voltage	V_N	0.60		1.4	0.84	1.01	V
Hysteresis voltage	V_H	1.10		1.5	1.10	1.5	V
Input rise/fall time	t_r, t_f	0		200	0	200	ns
Input rise/fall time, Schmitt	t_r, t_f	0		10	0	10	ns
I/O power supply voltage	V_{DD}						

Table 3. Input/Output Capacitance ($V_{DD} = V_I = 0 V$; $f = 1 MHz$)

Terminal	Symbol	Typ.	Max.	Unit
Input	C_{IN}	10	20	pF
Output	C_{OUT}	10	20	pF
I/O	$C_{I/O}$	10	20	pF

Note: Values include package capacitance.

Table 4. DC Characteristics ($V_{DD} = 3.3 V \pm 0.165 V$; $T_j = 0$ to $+70^\circ C$)

Parameter	Symbol	Min.	Typ.	Max.	Unit	Condition
All Buffer Types						
Output current, low (3 mA)	I_{OL}	3			mA	$V_{OL} = 0.4$ volt
Output current, low (6 mA)	I_{OL}	6			mA	$V_{OL} = 0.4$ volt
5-Volt-Tolerant Block						
Output current, high (3 mA)	I_{OH}	-3			mA	$V_{OH} = 2.4$ volts
Output current, high (6 mA)	I_{OH}	-3			mA	$V_{OH} = 2.4$ volts
3.3-Volt Interface Block						
Output current, high (3 mA)	I_{OH}	-3			mA	$V_{OH} = 2.4$ volts
Output current, high (6 mA)	I_{OH}	-6			mA	$V_{OH} = 2.4$ volts
Output voltage, high	V_{OH}	$0.9 V_{DD}$			V	$I_{OH} = -500 \mu A$
Output voltage, low	V_{OL}			$0.1 V_{DD}$	V	$I_{OL} = 1500 \mu A$
Vcc Current						
LCD only	I_{CC1}		60		mA	$V_{CC} = 3.3$ volts
						MCLK = 60 MHz
			VCLK = 20 MHz			
			PC Card off			
LCD plus PC Card active	I_{CC2}		90		mA	$V_{CC} = 3.3$ volts
						MCLK = 60 MHz
Hibernate mode	I_{CC3}		100		μA	Gated_I enable
						CRYL-INH enable
						LCD panel off
						Frame buffer PC Card self-refresh off

Table 5. Clock Operation

Parameter	Symbol	Min.	Typ.	Max.	Unit	Condition
X1, X2 crystal input	f_{xx}			50	MHz	Crystal oscillator
X2 clock input (Note)	F_x			66	MHz	External clock with 60 ns DRAMs
MCLK clock input	F_m			80	MHz	External clock with 50 ns DRAMs
				66.6	MHz	External clock with 60 ns DRAMs

Note: Leave X1 open with no MCLK input.

Figure 3. Preliminary Uncharacterized AC Timing

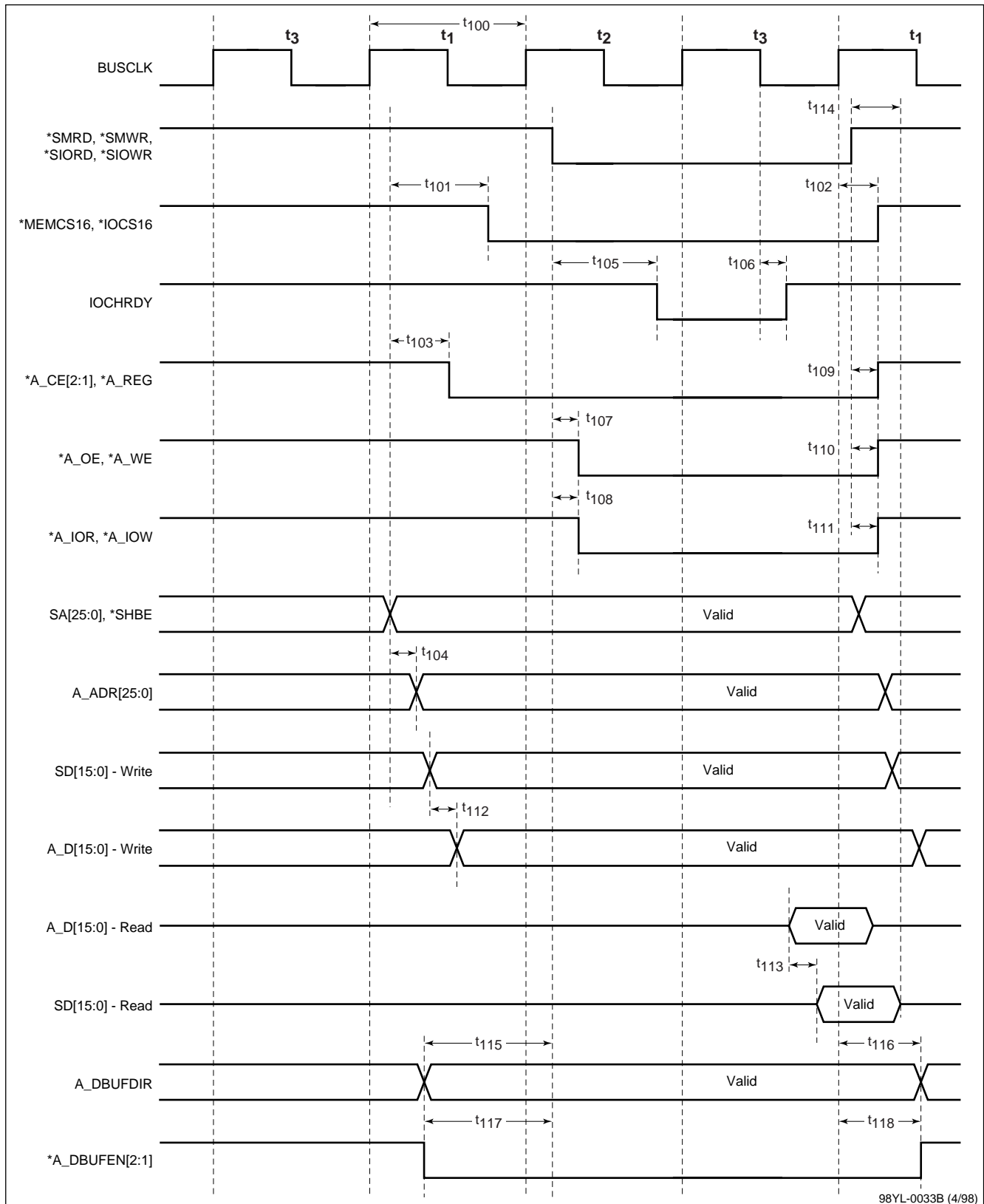

98YL-0033B (4/98)

Table 6. Uncharacterized AC Characteristics (refer to Figure 3)

Parameter	Symbol	Min.	Typ.	Max.	Unit
BUSCLK clock period	t100		125		ns
Slot A Only					
*MEMCS16, *IOCS16 ↓ delay from SA[23:0] address and *SBHE valid	t101		8	15	ns
*MEMCS16, *IOCS16 ↓ hold time from BUSCLK ↑	t102	3	4		ns
*A_CE[2:1], *A_REG ↓ delay from SA[23:0] address and *SBHE valid	t103		9	15	ns
A_ADR[25:0] address valid delay from SA[23:0] address and *SBHE valid	t104		5	9	ns
IOCHRDY valid delay from *SMRD, *SMWR, *SIORD, *SIOWR ↓	t105		4	7	ns
IOCHRDY hold time from BUSCLK ↓	t106	4	7		ns
*A_OE, *A_WE ↓ delay from *SMRD, *SMWR ↓	t107		6	10	ns
*A_IOR, *A_IOW ↓ delay from *SIORD, *SIOWR ↓	t108		7	12	ns
*A_CE[2:1], *A_REG ↑ delay from *SMRD, *SMWR, *SIORD, *SIOWR ↑	t109		9	15	ns
*A_OE, *A_WE ↑ delay from *SMRD, *SMWR ↑	t110		6	10	ns
*A_IOR, *A_IOW ↑ delay from *SIORD, *SIOWR ↑	t111		7	12	ns
SD[15:0] data valid to A_D[15:0] valid delay (write cycle)	t112		13	17	ns
SD[15:0] data valid delay from A_D[15:0] valid (read cycle)	t113		6	9	ns
SD[15:0] data hold time from *SMRD, *SMWR, *SIORD, *SIOWR ↑ (read cycle)	t114	4	6	9	ns
Slot A in Dual Slot Mode					
A_DBUFDIR delay from *SMRD, *SMWR, *SIORD, *SIOWR ↓	t115		6	9	ns
A_DBUFDIR hold time to *SMRD, *SMWR, *SIORD, *SIOWR ↑	t116	4	7		ns
A_DBUFEN[2:1] delay from *SMRD, *SMWR, *SIORD, *SIOWR ↓	t117		9	13	ns
A_DBUFEN[2:1] hold time to *SMRD, *SMWR, *SIORD, *SIOWR ↑	t118	5	8		ns

Note: All values are subject to change without notice.

Figure 4. DRAM Read Cycle

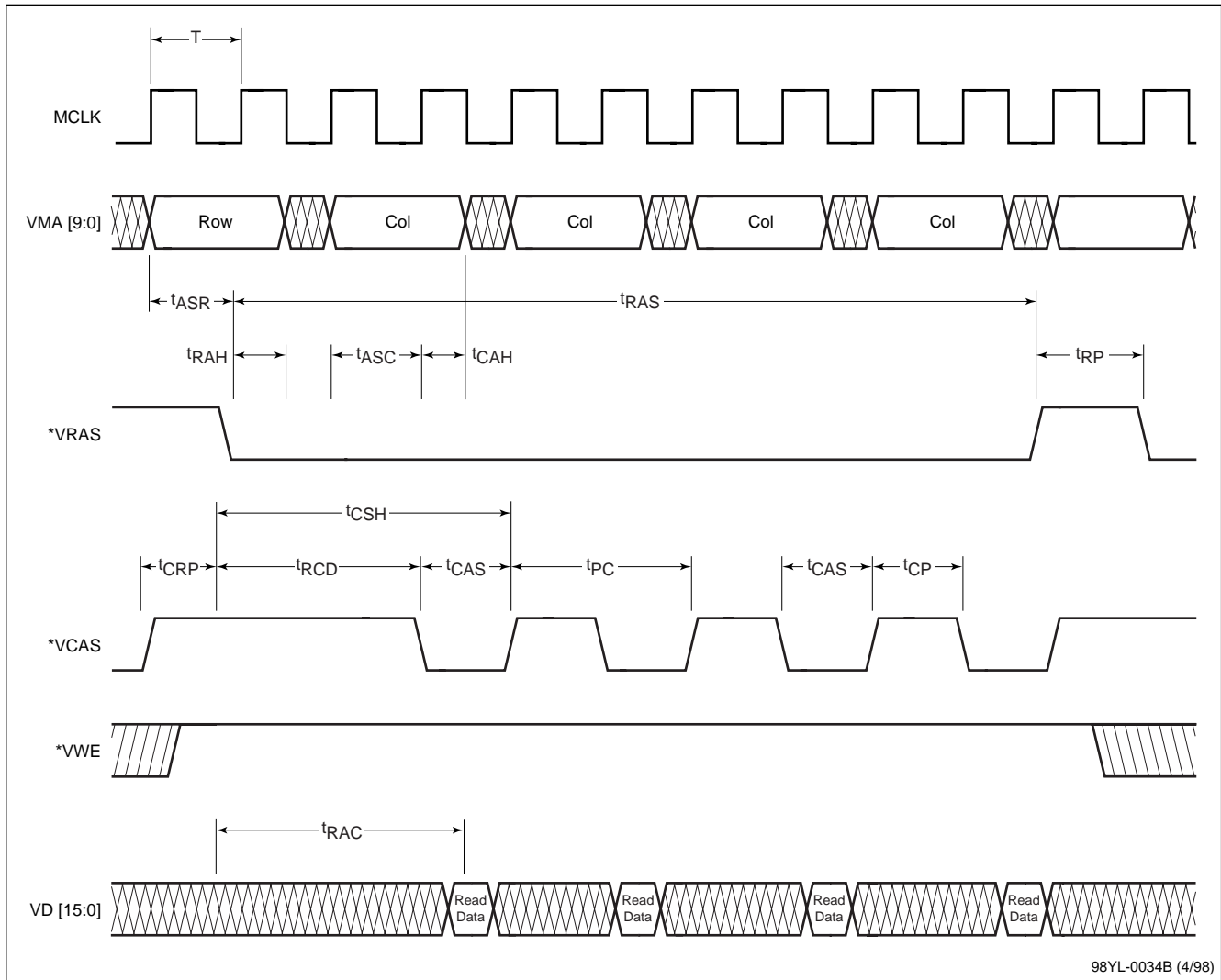

Figure 5. DRAM Write Cycle

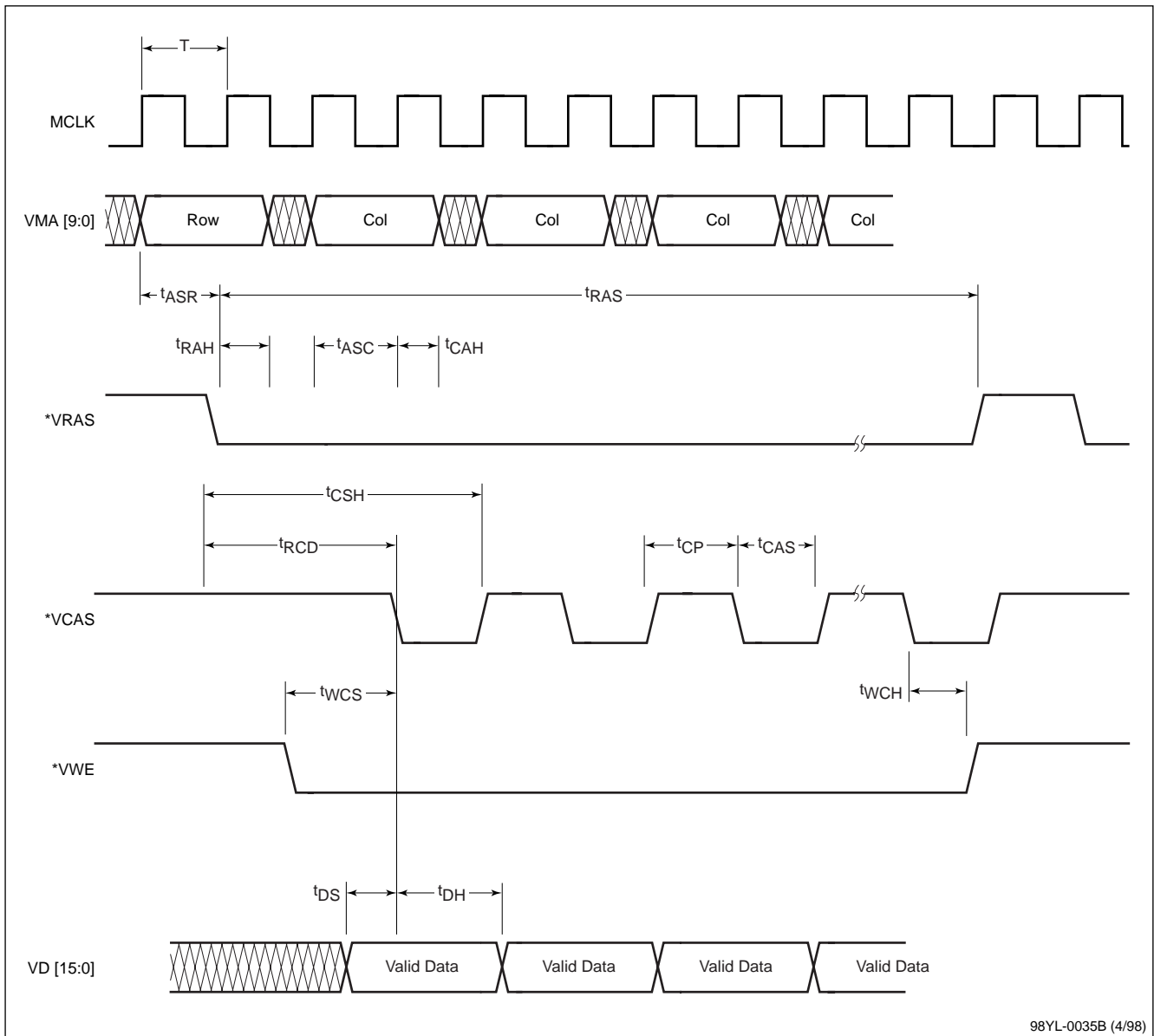

Table 7. DRAM Read Cycle Characteristics (refer to Figure 4)

Description	Symbol	Min.	Max.	Unit
Row address setup time	t _{ASR}	T		ns
Row address hold time	t _{RAH}	T-5		ns
Column address setup	t _{ASC}	T		ns
Column address hold time	t _{CAH}	T		ns
*VRAS pulse width	t _{RAS}	4.5T		ns
*VRAS precharge time	t _{RP}	3.5 T-3		ns
*VRAS to *VCAS delay time	t _{RCD}	3.5 T + 2		ns
*VCAS hold time	t _{CSH}	3 T + 2		ns
*VCAS pulse width	t _{CAS}	T - 1		ns
*VCAS precharge time	t _{CP}	T		ns
Data access time from *VRAS	t _{RAC}		4.5 T + 3	ns
Data access time from *VCAS	t _{CAC}		T + 3	ns

Note: MCLK is from either XTAL on X1 and X2 or from the external oscillator.

Table 8. DRAM Write Cycle Characteristics (refer to Figure 5)

Description	Symbol	Min.	Max.	Unit
Row address setup time	t _{ASR}	T		ns
Row address hold time	t _{RAH}	T-5		ns
Column address setup	t _{ASC}	T		ns
Column address hold time	t _{CAH}	T		ns
*VRAS pulse width	t _{RAS}	4.5 T		ns
*VRAS precharge time	t _{RP}	3.5 T-3		ns
*VCAS to *VRAS precharge time	t _{CRP}	3 T		ns
*VCAS hold time	t _{CSH}	3 T+2		ns
*VCAS pulse width	t _{CAS}	T- 1		ns
*VCAS precharge time	t _{CP}	T		ns
*VRAS to *VCAS delay time	t _{RCD}	3.5 T+2		ns
Write pulse setup time from *VCAS	t _{WCS}	2T		ns
Write pulse hold time from *VCAS	t _{WCH}	T		ns
Data setup time to *VCAS	t _{DS}	8		ns
Data hold time to *VCAS	t _{DH}	12		ns

Figure 6. System Bus Cycle

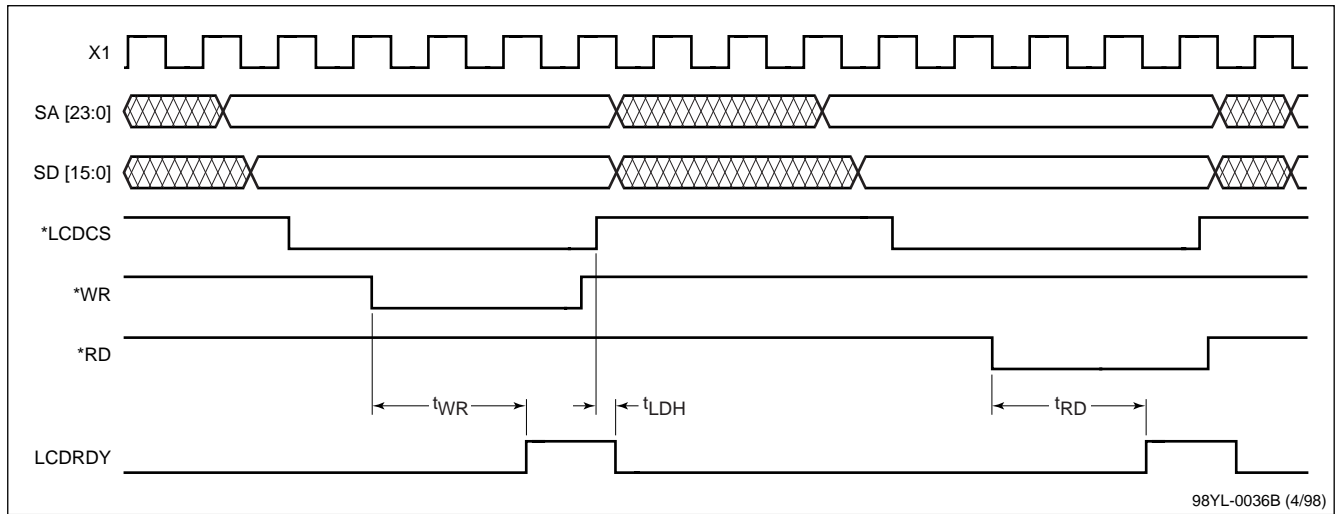

Table 9. System Bus Cycle Characteristics (refer to Figure 6)

Parameter	Symbol	Min	Max	Unit
LCDRDY to *LCDCS hold time	t_{LDH}	3	5	ns
*RD low to LCDRDY high time	t_{RD}	20	40	ns
*WR_L low to LCDRDY high time	t_{WR}	20	40	ns

Figure 7. *VCAS Before *VRAS Refresh Cycle

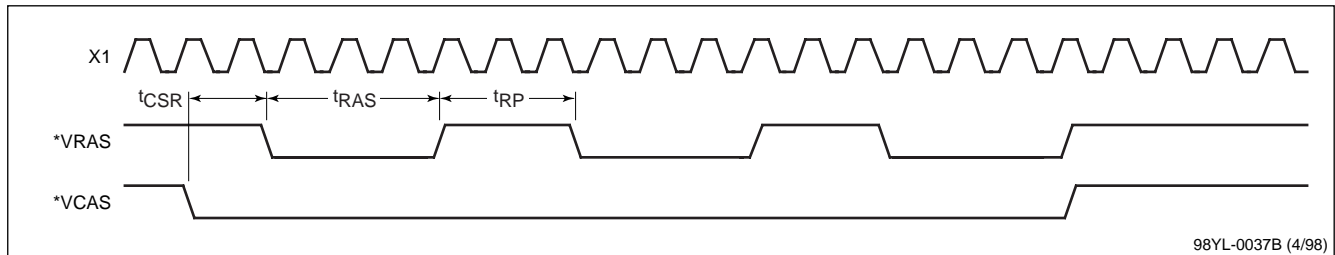

Table 10. *VCAS Before *VRAS Refresh Characteristics (refer to Figure 7)

Parameter	Symbol	Min	Max	Unit
*VCAS setup time	t_{CSR}	$1.5 T - 2$		ns
*VRAS pulse width	t_{RAS}	$3.5 T$		ns
*VRAS precharge time	t_{RP}	$3.5 T - 2$		ns

Figure 8. Video Display Timing for TFT Panel

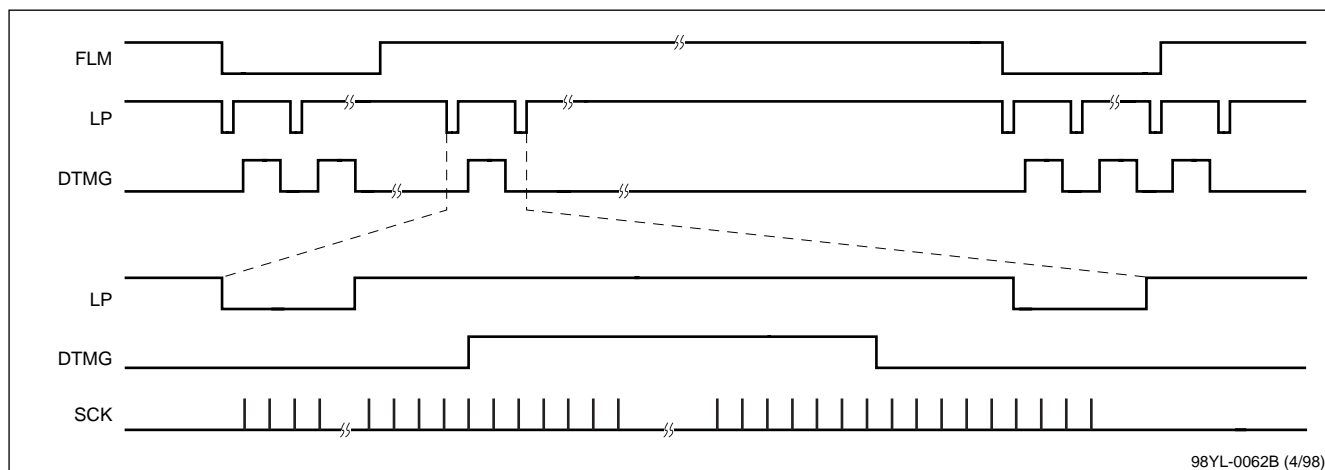
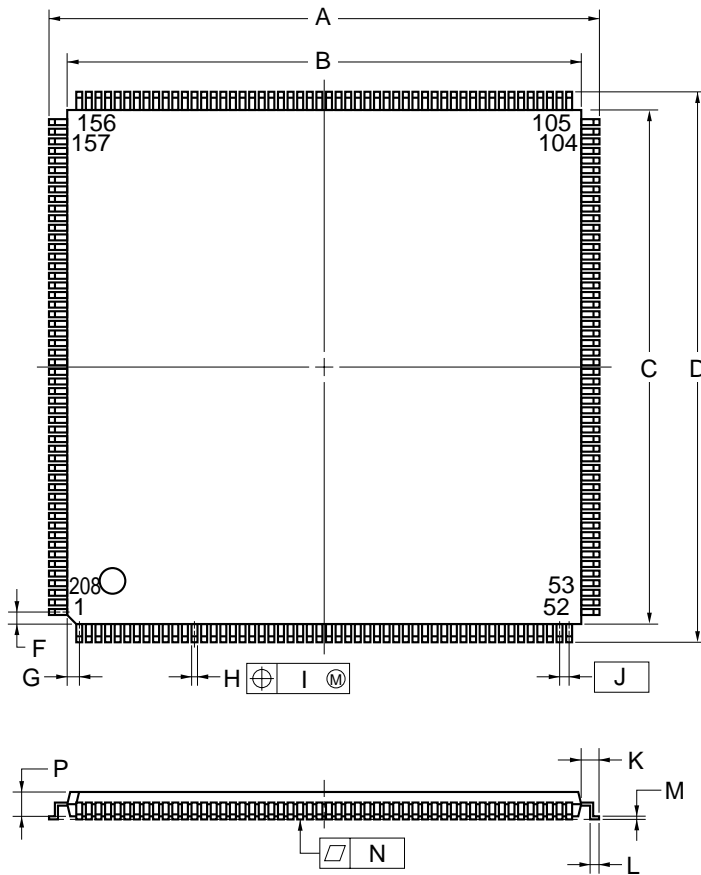

Figure 9. 208-Pin LQFP



ITEM	MILLIMETERS	INCHES
A	30.0±0.2	1.181±0.008
B	28.0±0.2	1.102 ^{+0.009} _{-0.008}
C	28.0±0.2	1.102 ^{+0.009} _{-0.008}
D	30.0±0.2	1.181±0.008
F	1.25	0.049
G	1.25	0.049
H	0.22 ^{+0.05} _{-0.04}	0.009±0.002
I	0.10	0.004
J	0.5 (T.P.)	0.020 (T.P.)
K	1.0±0.2	0.039 ^{+0.009} _{-0.008}
L	0.5±0.2	0.020 ^{+0.008} _{-0.009}
M	0.145 ^{+0.055} _{-0.045}	0.006±0.002
N	0.10	0.004
P	1.4±0.1	0.055±0.004
Q	0.125±0.075	0.005±0.003
R	3° ^{+7°} _{-3°}	3° ^{+7°} _{-3°}
S	1.7 MAX.	0.067 MAX.

S208GD-50-8EU-2

detail of lead end

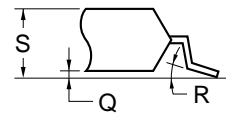

NOTE

Each lead centerline is located within 0.10 mm (0.004 inch) of its true position (T.P.) at maximum material condition.

Some of the information contained in this document may vary from country to country. Before using any NEC product in your application, please contact a representative from the NEC office in your country to obtain a list of authorized representatives and distributors who can verify the following:

- Device availability
- Ordering information
- Product release schedule
- Availability of related technical literature
- Development environment specifications (for example, specifications for third-party tools and components, host computers, power plugs, AC supply voltages, and so forth)
- Network requirements

In addition, trademarks, export restrictions, and other legal issues may also vary from country to country.

NEC Electronics Inc. (U.S.)

Santa Clara, California
Tel: 800-366-9782
Fax: 800-729-9288

NEC Electronics (France) S.A.

Velizy-Villacoublay, France
Tel: 01-30-67 58 00
Fax: 01-30-67 58 99

NEC Electronics Hong Kong Ltd.

Seoul Branch
Seoul, Korea
Tel: 02-528-0303
Fax: 02-528-4411

NEC Electronics (Germany) GmbH

Duesseldorf, Germany
Tel: 0211-65 03 02
Fax: 0211-65 03 490

NEC Electronics (France) S.A.

Spain Office
Madrid, Spain
Tel: 01-504-2787
Fax: 01-504-2860

NEC Electronics Singapore Pte. Ltd.

United Square, Singapore 1130
Tel: 253-8311
Fax: 250-3583

NEC Electronics (UK) Ltd.

Milton Keynes, UK
Tel: 01908-691-133
Fax: 01908-670-290

NEC Electronics (Germany) GmbH

Scandinavia Office
Taebly, Sweden
Tel: 08-63 80 820
Fax: 08-63 80 388

NEC Electronics Taiwan Ltd.

Taipei, Taiwan
Tel: 02-719-2377
Fax: 02-719-5951

NEC Electronics Italiana s.r.l.

Milano, Italy
Tel: 02-66 75 41
Fax: 02-66 75 42 99

NEC Electronics Hong Kong Ltd.

Hong Kong
Tel: 2886-9318
Fax: 2886-9022/9044

NEC do Brasil S.A.

Sao Paulo-SP, Brasil
Tel: 011-889-1680
Fax: 011-889-1689

NEC Electronics (Germany) GmbH

Benelux Office
Eindhoven, the Netherlands
Tel: 040-2445845
Fax: 040-2444580

V_R Series, V_{RC}4171, V_{RC}4171A, and V_R4100 are either trademarks or registered trademarks of NEC Corporation in the United States and/or other countries. MIPS is a registered trademark of MIPS Technology, Inc. PC Card is a trademark of the Personal Computer Memory Card International Association. CompactFlash is a trademark of the CompactFlash Association. Miniature Card is a trademark of the Miniature Card Implementers Forum. Windows and Windows CE are either trademarks or registered trademarks of Microsoft Corporation.

NEC

For literature, call **1-800-366-9782** 7 a.m. to 6 p.m. Pacific time
or FAX your request to **1-800-729-9288**
or visit our web site at **www.nec.com**

NEC Electronics Inc.

CORPORATE HEADQUARTERS
2880 Scott Boulevard
Santa Clara, CA 95050-2554
TEL 408-588-6000

In North America: No part of this document may be copied or reproduced in any form or by any means without the prior written consent of NEC Electronics Inc. (NECEL). The information in this document is subject to change without notice. All devices sold by NECEL are covered by the provisions appearing in NECEL Terms and Conditions of Sales only. Including the limitation of liability, warranty, and patent provisions. NECEL makes no warranty, express, statutory, implied or by description, regarding information set forth herein or regarding the freedom of the described devices from patent infringement. NECEL assumes no responsibility for any errors that may appear in this document. NECEL makes no commitments to update or to keep current information contained in this document. The devices listed in this document are not suitable for use in applications such as, but not limited to, aircraft control systems, aerospace equipment, submarine cables, nuclear reactor control systems, and life support systems. "Standard" quality grade devices are recommended for computers, office equipment, communication equipment, test and measurement equipment, machine tools, industrial robots, audio and visual equipment, and other consumer products. For automotive and transportation equipment, traffic control systems, anti-disaster and anti-crime systems, it is recommended that the customer contact the responsible NECEL salesperson to determine the reliability requirements for any such application and any cost adder. NECEL does not recommend or approve use of any of its products in life support devices or systems or in any application where failure could result in injury or death. If customers wish to use NECEL devices in applications not intended by NECEL, customer must contact the responsible NECEL salespeople to determine NECEL's willingness to support a given application.